



The Application of Peroxide for Organic Synthesis in Continuous Flow Chemistry

Rui Zhu¹ Yi-Bo Zhou¹ Han-Qi Zhou¹ Feng-Fan Liu^{1,2*}

¹Key Laboratory for Green Pharmaceutical Technologies and Related Equipment of Ministry of Education and Key Laboratory of Pharmaceutical Engineering of Zhejiang Province, Collaborative Innovation Center of Yangtze River Delta Region Green Pharmaceuticals, Zhejiang University of Technology, Hangzhou, People's Republic of China

²Zhejiang Governor Triangle Biomedical Industrial Technology Research Park, Huzhou, People's Republic of China

Address for correspondence Feng-Fan Liu, PhD, Collaborative Innovation Center of Yangtze River Delta Region Green Pharmaceuticals, Zhejiang University of Technology, 18 Chaowang Road, Hangzhou 310014, People's Republic of China (e-mail: liufengfan@zjut.edu.cn).

Pharmaceut Fronts 2023;5:e243–e253.

Abstract

Peroxides, as high-efficiency oxidants, are widely used in various areas of industry, such as chemical, pharmaceutical, environmental protection, etc. However, their applications in batches are limited due to their explosive and unstable nature. Continuous flow reactions have the advantages of a large area-to-surface ratio, high mixing efficiency, high mass and heat transfer performance, accurate control of process parameters, and high security. These are beneficial for the improvement of the product yield and the reduction of the reaction time and risk. Thus, in the reaction involving peroxide, continuous flow technology can effectively improve the operational safety and enhance the reaction efficiency of peroxides. This review summarized the applications of peroxides in various organic syntheses in continuous-flow chemistry. These examples illustrated the promising prospects of peroxides in green organic synthesis.

Keywords

- ▶ peroxides
- ▶ continuous flow technology
- ▶ green organic synthesis

Introduction

Hydrogen peroxide (H₂O₂) can be regarded as a green oxidant in the chemical industry.^{1,2} H₂O₂ is the simplest form of peroxides and is mainly prepared by the anthraquinone (AO) process.^{3,4} H₂O₂ has a unique advantage compared with inorganic metal oxidants because its only by-product is water.^{5,6} However, H₂O₂ usually needs to combine with other reagents as a terminal oxidant to participate in a wide variety of reactions (▶ Fig. 1).^{3,7}

In organic synthesis, peroxides are widely used to oxidize alcohols, aldehydes, olefins, etc., however, the potential hazards associated with peroxides and organic compounds limit their practical development, for example, the thermal runaway process of the mixture of H₂O₂ and 1,3,5-trimethylbenzene, demonstrated by Qian et al through a method

combining reactive molecular dynamics (ReaxFF MD) and density function theory.⁸ They elucidated the mechanism of the explosion hazard. They also emphasized that controlling H₂O₂ and substrate concentrations outside the explosive range can effectively reduce the activity of the explosive system. In traditional industrial production, batch or tandem batch is used for peroxidation reaction, yet it tends to cause localized heat accumulation in the reactor that may even lead to an explosion. In the scale-up, the thermal control of the peroxide reaction is usually achieved by a “de-intensification” in the batch mode, whereby avoiding high concentrations of peroxide, lowering the reaction temperature, and preventing the concentration of the peroxide solution.^{9,10} Therefore, the safe use of peroxides has always been of great concern, both in the laboratory and chemical industry.

received
July 30, 2023
accepted

November 15, 2023
article published online
December 8, 2023

DOI <https://doi.org/10.1055/s-0043-1777426>.
ISSN 2628-5088.

© 2023. The Author(s).

This is an open access article published by Thieme under the terms of the Creative Commons Attribution License, permitting unrestricted use, distribution, and reproduction so long as the original work is properly cited. (<https://creativecommons.org/licenses/by/4.0/>)
Georg Thieme Verlag KG, Rüdigerstraße 14, 70469 Stuttgart, Germany

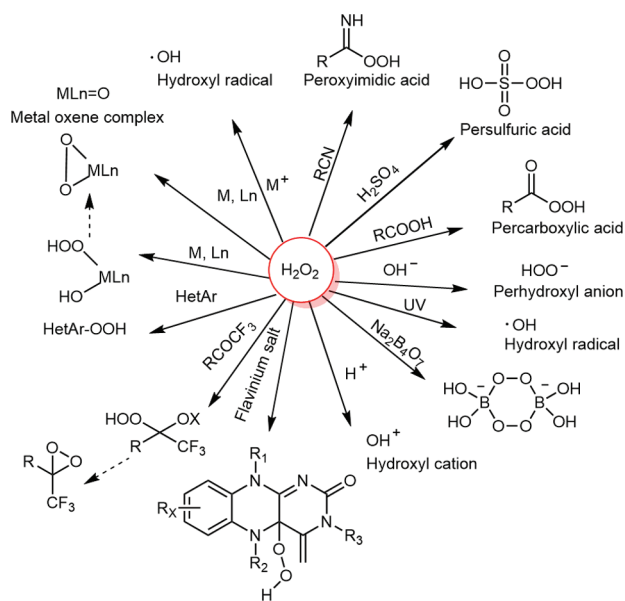

Fig. 1 The activation modes of hydrogen peroxide.

Continuous flow technology is safe, efficient, and convenient in comparison with batch reactions.^{11–13} It can be used to address safety issues of peroxide in large-scale reactions. Flow reactors have a large area-to-surface ratio that provides excellent heat exchange and prevents localized hot spots. Continuous flow technology allows for continuous operation where peroxides can be transported to the reaction site for continuous consumption rather than accumulating in one unit of the reactor. Flow reactors also allow for precise control of reaction parameters, thus, enhancing the safety and efficiency of the whole process. However, the transition from batch reaction to continuous flow reaction still faces challenges, e.g., pipe blockage and the advances in online analytical techniques, and international coordination of continuous flow technology needs to be improved to reduce barriers to technology implementation and regulation. Peroxides play an important role in organic synthesis.^{2,14,15} This

article attempts to summarize the successful applications of peroxides in continuous-flow reactors and supplement the safe use of the compounds in the synthesis process.

Peroxide Preparation

The continuous flow technology has expanded our capabilities for the preparation of peroxides. In addition to the AO process, Freakley et al demonstrated a direct synthesis of H_2O_2 from O_2 and H_2 using Au-Pd as catalysts, and the reaction conditions in a continuous flow system were: 10 bar, $2^\circ C$, total gas flow rate of 42 N mL/min, $H_2/O_2 = 1$, 66% MeOH and 34% H_2O as a solvent, solvent flow rate of 0.2 mL/min and 120 mg catalyst, the net synthesis rate of H_2O_2 is $2.2 \text{ mol} \cdot \text{kg}_{\text{cat}}^{-1} \cdot \text{h}$.¹⁶ Furthermore, a simple kinetic model is proposed to guide the synthesis of H_2O_2 , and it showed that it is the decomposition reaction, rather than the hydrogenation reaction, that has the greatest effect on the amount of H_2O_2 generated. The gas composition should be kept below the lower explosive limit of H_2 , which is 5% in air at room temperature.

Maralla and Sonawane synthesized performic acid (PFA) in a polytetrafluoroethylene spiral capillary microreactor using formic acid as a reactant.¹⁷ The preferred reaction parameters were $30^\circ C$, a feed flow rate of 10 mL/h, and 30% H_2O_2 , and the maximum PFA (5.175 mol/L) was obtained in 6 minutes. The reaction device could provide a reference for the preparation of similar peroxides (►Fig. 2). Gaikwad et al synthesized PFA in Corning advanced-flow reactors using formic acid and H_2O_2 as reactants and sulfuric acid as a homogeneous catalyst.¹⁸ The preferred reaction parameters were $30^\circ C$, a flow rate of 80 mL/h, and 1 w/w% H_2SO_4 , and the maximum PFA was obtained within 1 minute. Katuri et al produced PFA in a T-junction spiral capillary microreactor system using formic acid and H_2O_2 as substrates and Amberlite IR 120 Na as a catalyst.¹⁹ As a heterogeneous catalyst, Amberlite IR 120 Na is preferred because of its ability to reduce reactor corrosion and solve product separation problems compared with homogeneous catalysts. Under the parameters of $30^\circ C$ and 6 wt % catalyst, the maximum PFA (2.8 mol/L) was obtained in 10 minutes.

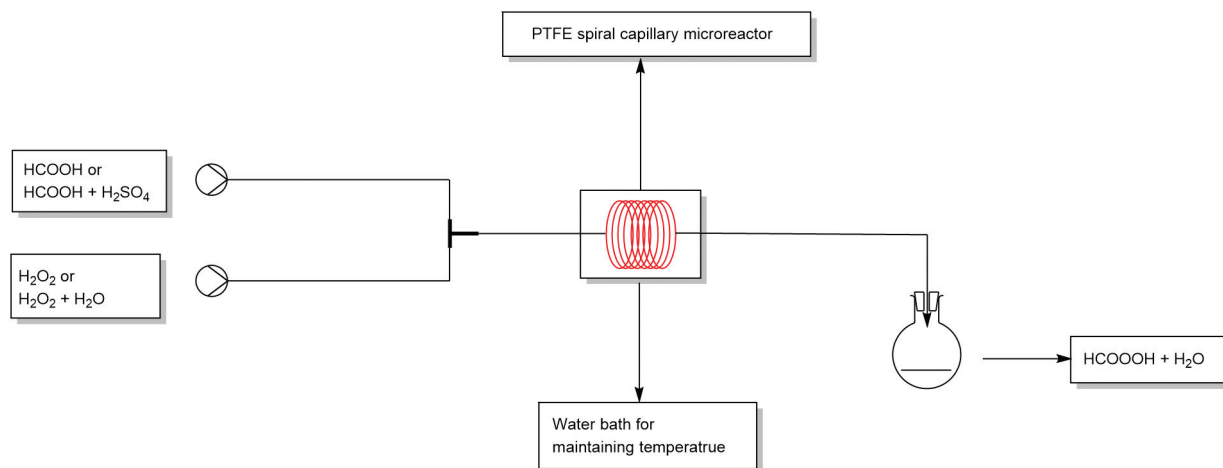

Fig. 2 Schematics of experimental set-up for performic acid synthesis.

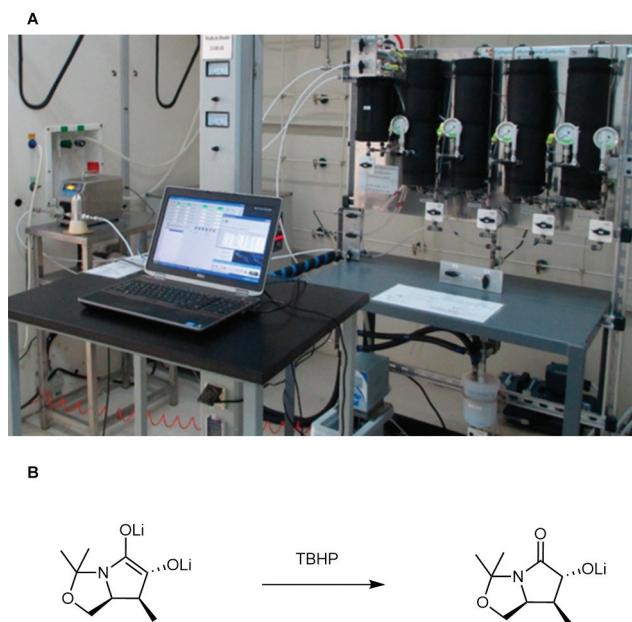
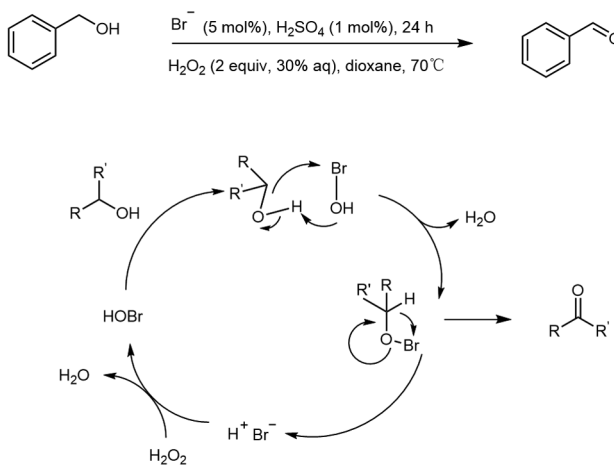

Fig. 3 (A) Pervaporation system at the kilo laboratory facility. (B) Synthesis of a key lactam intermediate.

Peroxyacetic acid (PAA) is unstable due to its rapid thermal decomposition; therefore, safety concerns need to be taken into account when producing and using PAA. Jolhe et al synthesized PAA in a continuous flow micro-structured reactor in the presence of ultrasonic irradiations innovatively.²⁰ The results showed that the concentration of PAA reached 3.375 mol/L in 60 minutes in a batch reaction while 5.12 mol/L within 10 minutes in a continuous flow. Maralla and Sonawane also proposed a safe and efficient synthesis of PAA under a continuous flow condition.²¹ They verified the kinetics in detail and investigated the effect of three different flow reactors on the efficiency of PAA production. The results showed that a spiral capillary reactor produced PAA with the best efficiency. The preferred reaction conditions were 50°C, a feed flow rate of 6.7 mL/h, and acetic acid/ H₂O₂ (1:1, a molar ratio), and the maximum PAA (3.751 mol/L) was obtained in 9 minutes.

Li et al synthesized anhydrous *tert*-butyl hydroperoxide (TBHP) in the presence of membrane pervaporation.²² The pervaporation skid was included, and the pervaporation system is shown in ▶Fig. 3A. The process ran for more than 96 hours and successfully obtained a target of 0.15 wt % water. The advantage of this process was that TBHP could be produced on demand at low temperatures, avoiding the need to store large quantities of reaction solution under



Scheme 1 Proposed mechanism of the oxidation of alcohols to carbonyl compounds.

batch conditions. TBPH obtained was directly used to oxidize γ -butyrolactam substrate to prepare key pharmaceutical intermediates (▶Fig. 3B).

Oxidation of Hydroxyl Compounds

Hydroxyl compounds can be oxidized by several conventional oxidants, including inorganic metal oxidants, high-valued iodine oxidants, and TEMPO (2,2,6,6-tetramethylpiperidin-1-oxyl).²³ However, these oxidants are costly and environmentally unfriendly and may pose challenges in terms of functional group compatibility.

In 2021, Kon et al performed a selective oxidation of cinnamyl alcohol to cinnamaldehyde in a continuous flow reactor in the presence of H₂O₂.²⁴ This can be achieved by optimizing the concentration of Pt black and the contact time of the substrate with Pt and H₂O₂. H₂O₂ decomposition was also prevented. The aldehydes obtained can be directly used in subsequent organic transformations. In 2022, the same group selectively oxidized alcohols to aldehydes and carboxylic acids in flow reactors in the presence of Pt catalyst and H₂O₂ for the first time (▶Fig. 4).²⁵ Carboxylic acids were obtained at 90°C and a flow rate of 0.1 mL/min, with a yield of 94%. Lowering the temperature to 40°C and increasing the flow rate to 0.425 mL/min contributed to the production of aldehydes in a yield of 98%. Interestingly, the catalytic activity of Pt increases as the temperature increases from 40 to 90°C. Liu et al oxidized alcohols to carbonyl compounds using H₂O₂ in combination with catalytic amounts of bromide ions (Br⁻) and acid.²⁶ A possible mechanism is proposed in ▶Scheme 1. The mechanism is

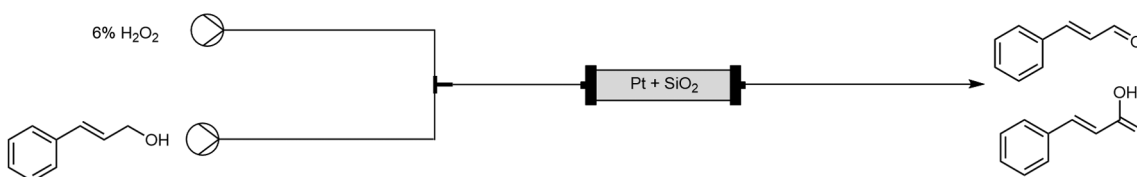
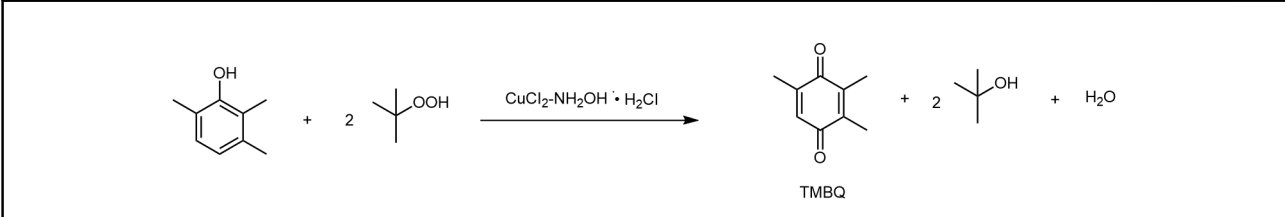

Fig. 4 Selective oxidation of alcohols in a continuous flow.

Table 1 Comparison between a batch reactor and microreactors for the yield of TMBQ

Reactor	Reaction time (min)	Yield of TMBQ (%)	Space time yield (kg/(L·h))
Batch reactor	120	80	0.011
Microreactor (one injection of TBHP)	12	68	0.330
Microreactor (two injection of TBHP)	12	73	0.360

Abbreviation: TMBQ, 2,3,5-trimethylbenzoquinone.

important in the selective oxidation of compounds containing two or more hydroxyl groups because of the higher reactivity selectivity of secondary alcohols compared with that of primary alcohols.

Derikvand et al screened silver oxide (Ag_2O) as a heterogeneous catalyst, combined with H_2O_2 as a green oxidant to oxidize hydroquinones to benzoquinones, with a product yield of up to 95%.²⁷ Ag_2O can be recycled at least five times and can be filled in continuous flow reactors to perform the same oxidation reaction with a similar experimental result. Using TBHP, Li et al synthesized 2,3,5-trimethylbenzoquinone (TMBQ) from 2,3,6-trimethylphenol in a continuous flow.²⁸ The optimal reaction temperature was 40°C, the residence time was 12 minutes, and the inner diameter of the microreactor can be negligible. The two-injection strategy of TBHP resulted in a higher space-time yield of 0.36 kg/(L × h) compared with the batch reactor and the one-injection strategy (►Table 1).

Oxidation of Carbonyl Compounds

Oxidation of carbonyl compounds is a common method for the preparation of various carboxylic acids. Prieschl et al conducted an oxidation of aldehyde in continuous flow in the presence of PFA.²⁹ The hazards of potentially explosive reagents were safely eliminated. They dissolved the substrate directly in formic acid and obtained carboxylic acid in 86% yield in 20 minutes under 90°C and 1 equiv. H_2O_2 ; however, the poor solubility of the raw material had the risk of

clogging the pipeline. They solved the problem by dissolving the substrate in ethyl acetate and obtained the target with 99% yield in 20 minutes (►Fig. 5). Flow processes are rarely used in the synthesis of chiral drugs. γ -Nitrobutyric acids are key intermediates of the GABA analogues baclofen, phenibut, and fluorophenibut. In 2020, Ötvös et al asymmetrically synthesized chiral γ -nitrobutyric acids via a two-step telescoped continuous flow process.³⁰ α,β -Unsaturated aldehydes were first converted to γ -nitroaldehydes via enantioselective Michael-type addition, then, the γ -nitroaldehydes obtained were oxidized to γ -nitrobutyric acids by *in situ*-generated PFA (►Fig. 6).

Olefin Oxidation

Epoxidation reactions play an important role in organic synthesis. Epoxides are useful in the establishment of chiral centers. Limnios and Kokotos introduced the epoxidation reaction of various styrenes using 2,2,2-trifluoroacetophenone as an organocatalyst and H_2O_2 as a green oxidant.³¹ However, due to poor mixing properties and exothermic decomposition of H_2O_2 , the process took an hour to scale up. Yuan et al performed the reaction in a commercial fluidic reactor.³² This process takes 3.17 minutes with a substrate conversion of 96.7% and a product yield of 91.8%, which greatly reduced the reaction time and ensured the safety and continuity of operation (►Fig. 7). Mohammed et al performed an epoxidation reaction of 1-hexene and 4-vinyl-1-cyclohexene

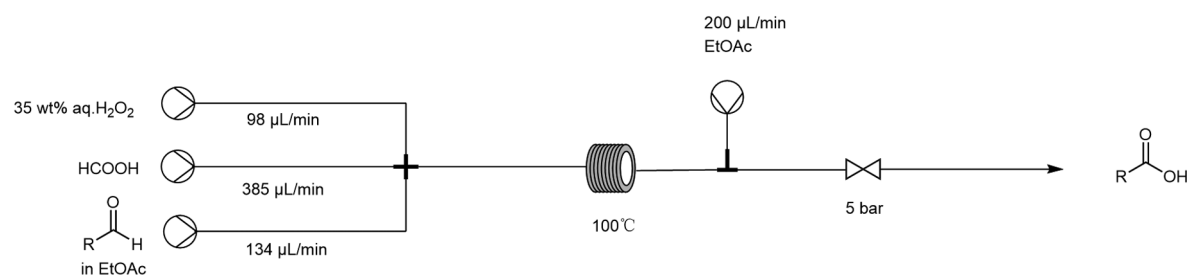
**Fig. 5** Oxidation of aldehydes in a continuous flow.

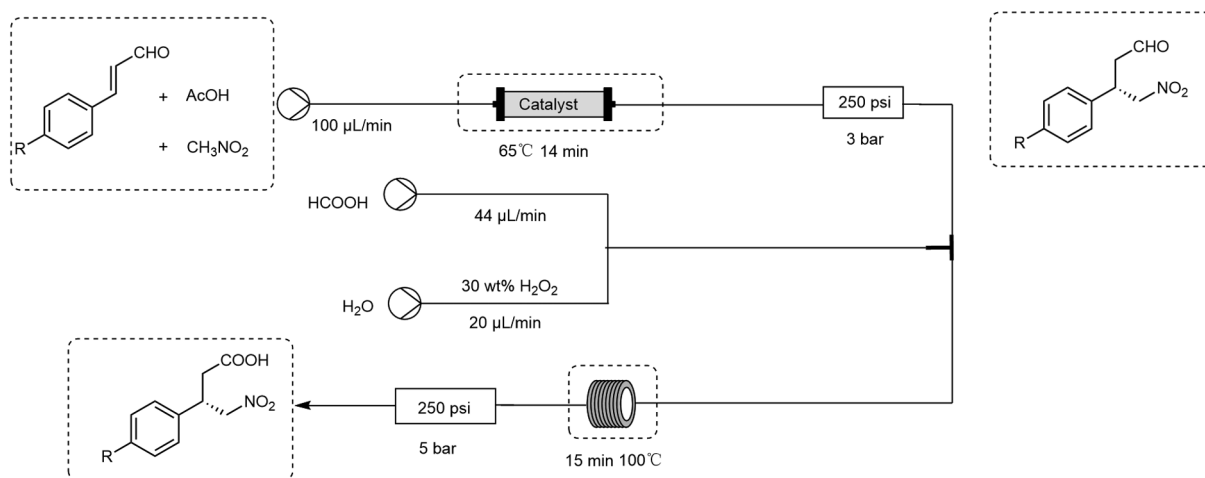

Fig. 6 Asymmetric synthesis of chiral γ -nitrobutyric acids via a two-step continuous flow.

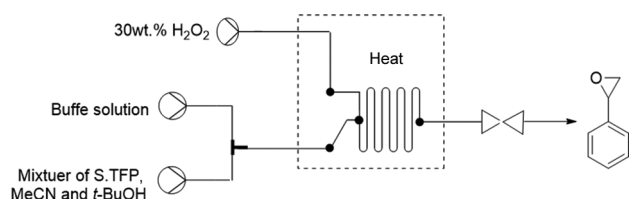

Fig. 7 Flow chart of operating mode of organocatalyzed epoxidation reaction of styrene.

(4-VCH) using Ps-AMP-Mo (polystyrene 2-(aminomethyl) pyridine-supported molybdenum (VI) complex) as a catalyst, and TBHP as an oxidant.³³ The data showed that the reaction time in the FlowSyn reactor (5 minutes) was significantly reduced in comparison to that in the batch reactor (40 minutes). The conversion of TBHP and the yield of 4-VCH 1,2-epoxide were found to be $95 \pm 4\%$ and $82 \pm 4\%$, respectively. Similarly, Tibbetts et al utilized a recyclable tungsten-based polyoxometalate phase transfer catalyst ($\text{PW}_4\text{O}_{24}[\text{PTC}]_3$) and aqueous H_2O_2 as a benign oxidant to perform a solvent-free continuous flow epoxidation of alkenes, which enabled safe epoxidation of a range of renewable terpenes.³⁴ A static mixing channel with rapid mass and heat transfer allowed for fast epoxidation

reactions and excellent temperature control (**Fig. 8**). VPTC (Venturello Phase Transfer Catalyst)/ H_2O_2 flow epoxidation conditions were optimized to prepare epoxide products in short reaction times. Under the conditions of 50°C , 1.6 equiv. H_2O_2 , and feed flow rate of 2.7 mL/h, the conversion rate of olefin reached 89% in 16.7 minutes.

The hydroboration/oxidation of olefins can be used to prepare primary alcohols and is commonly used to insert hydroxyl groups in the total synthesis of natural products or drugs.³⁵ Due to the rapid exothermic nature of the reaction, Souto et al used a flow-through process to accelerate heat dissipation and implemented online purification techniques to produce alcohols efficiently.³⁶ When the reaction temperature is 25°C , the reaction time was reduced from 4 hours (in a batch) to 50 minutes, and the yield of alcohol was 92%. Innovative continuous extraction and collection of organic solvents was achieved with a customized glass extraction unit (**Fig. 9**).

H_2O_2 also participated in the direct oxidation of olefins to various carboxylic acids. Wen et al conducted a clean production of adipic acid (AA) using H_2O_2 as an oxidant and H_2WO_4 , H_2SO_4 , and H_3PO_4 as catalysts, which can be recycled 20 times.³⁷ AA was produced in a laboratory continuous flow

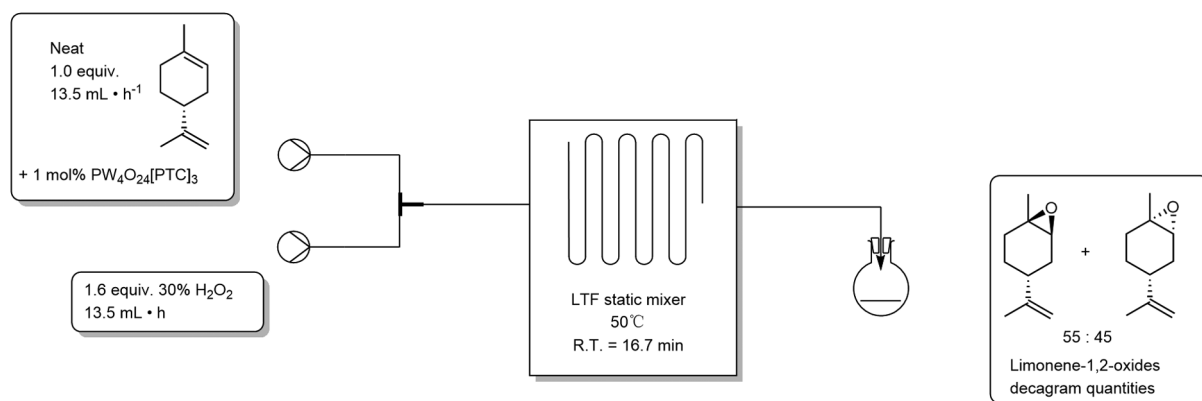

Fig. 8 Epoxidation of limonene in a continuous flow.

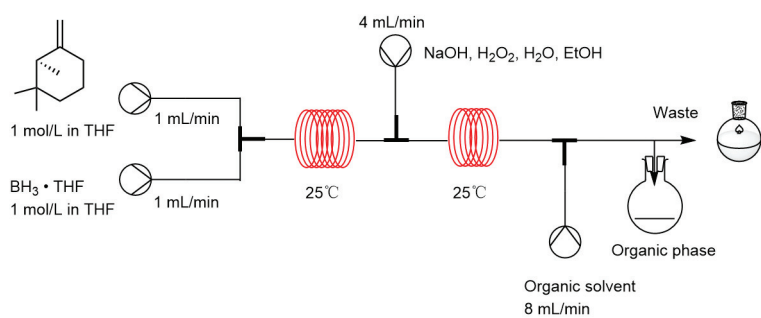

Fig. 9 Continuous flow extraction.

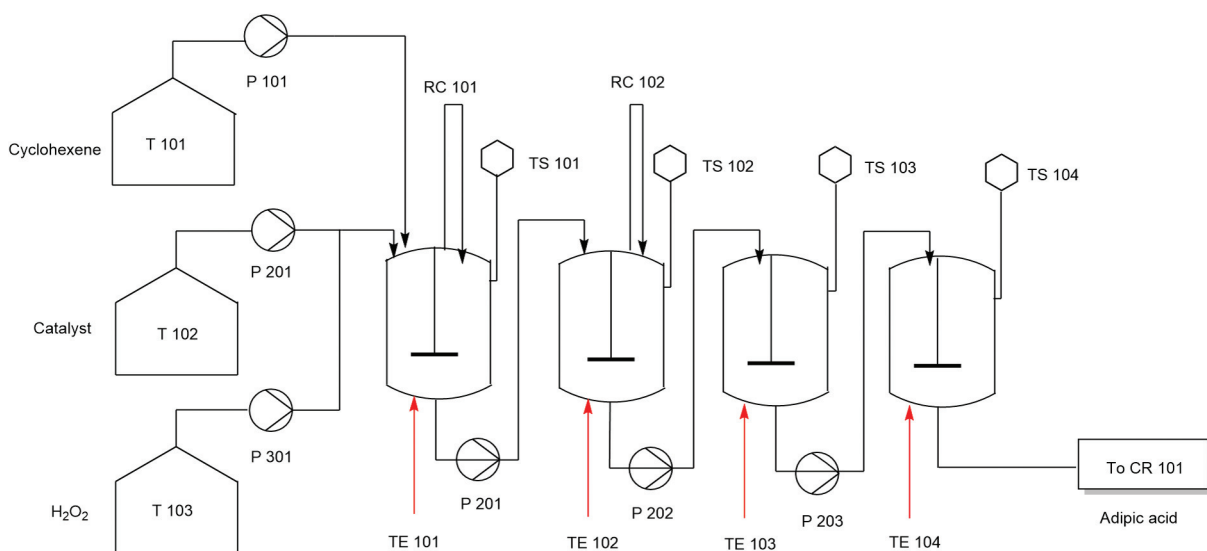

Fig. 10 Simplified process flow diagram for the oxidation of cyclohexene to adipic acid.

system in 94.1% yield using cyclohexene as a reactant. The pilot plant scaled up 10,000-fold for continuous operation, and AA was achieved in 94.7% yield (►Fig. 10). Shang et al used $\text{Na}_2\text{WO}_4 \cdot 2\text{H}_2\text{O}$ as a catalyst, $[\text{CH}_3(n\text{-C}_8\text{H}_{17})_3\text{N}]\text{HSO}_4$ as a phase transfer catalyst, and H_2O_2 as a benign oxidant to oxidize cyclohexene to AA in a solvent-free continuous flow.³⁸ In this work, AA was achieved with a yield of 50% within 20 minutes, which obtained a higher space–time yield of $0.57 \text{ kg L}^{-1}\text{h}^{-1}$ compared with the batch (►Table 2).

Oxidation of Sulfur Compounds

Sulfone and sulfoxide are usually prepared from thioethers and the most important concern is the selectivity of the oxidation. Maggi et al performed a highly selective oxidation of sulfides to sulfoxides in a continuous flow reactor under mild conditions and no metal catalysts.³⁹ The reaction parameters were 22°C , a stoichiometric amount of 30% H_2O_2 (aq), and a residence time of 25 minutes. Sulfoxide was obtained in 94% yield and 99% selectivity. Then, diluted

H_2O_2 was tried, and encouragingly, the oxidation of thioanisole still proceeded successfully, which was the first example (►Fig. 11). Mangiavacchi et al achieved a switchable synthesis of sulfones and sulfoxides from sulfides in flow reactors with the catalyst perselenic acid, which was *in situ* generated by the oxidation of selenium oxide in H_2O_2 (aq).⁴⁰ The reaction was conducted at a feed flow rate of 0.1 mL/min and 2 equiv. of H_2O_2 , and obtained sulfoxides in a yield of 85% and a chemoselectivity of 100%. When the amount of H_2O_2 was increased from 2 to 10 equiv., there was only a single product, sulfone. The mechanism for the catalytic cycle was proposed as shown in ►Scheme 2.

Doherty et al utilized the peroxometalate-based polymer-immobilized ionic liquid phase catalyst $[\text{PO}_4\{\text{WO}(\text{O}_2)_2\}_4]\text{@PIILP}$ as a heterogeneous catalyst, and H_2O_2 (aq) as the oxidant for the oxidation of sulfides to the corresponding sulfones and sulfoxides in a continuous flow.⁴¹ Solvent has an important effect on the reaction; when methanol was used as a solvent, the conversion rate of sulfide was 83% with a sulfoxide selectivity of 98% in 4 minutes, when acetonitrile was used as a solvent, the

Table 2 Comparison between a batch reaction and a flow reaction for the generation of adipic acid

Entry	Reactor	Reaction time (min)	STY [kg L ⁻¹ h ⁻¹]
1	Batch reactor	480	0.03
2	Packed-bed microreactor	20	0.57

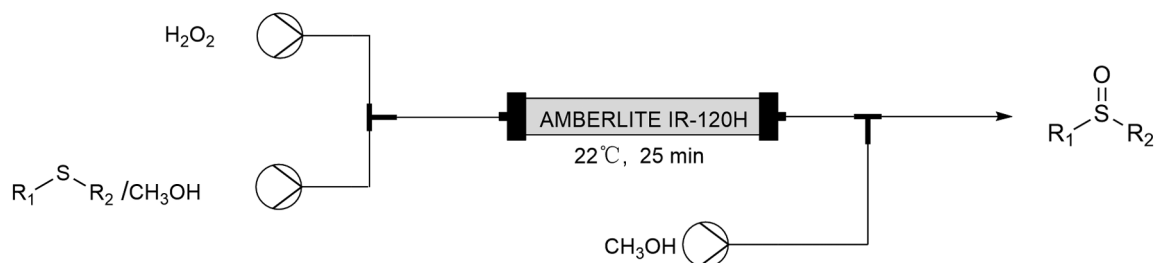
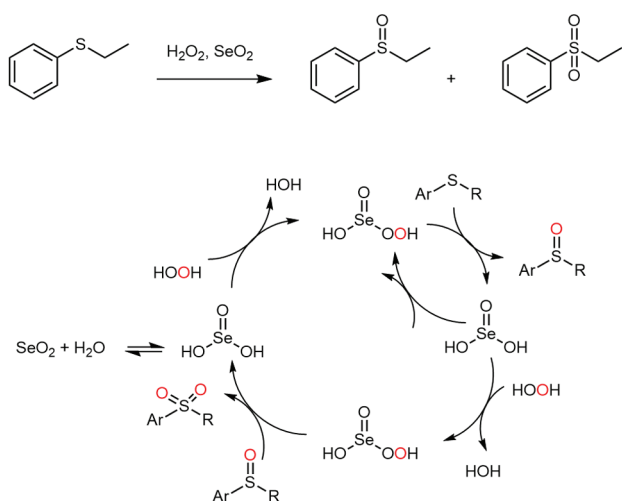
**Fig. 11** Highly selective oxidation of thioethersulphides with H₂O₂ in a continuous flow.**Scheme 2** Proposed mechanism of the oxidation of thioethers to the corresponding sulfone and sulfoxide.

conversion rate of sulfide was 100% with a sulfone selectivity of 96% in 15 minutes. The immobilized catalyst maintained its activity for 8 hours under a continuous flow condition. Zhang et al reported a simple and efficient oxidation of thioether into 2,3-dimethyl-4-methylsulfonylbromobenzene under flow conditions using PAA as an oxidant, which was *in situ* generated from the oxidation of acetic acid (CH₃COOH) in diluted H₂O₂ (aq).⁴² The three-stream micromixing process improved the efficiency and safety of the reaction significantly and greatly reduced the reaction time (6 minutes) compared with the batch reactor (75 minutes) (► **Table 3**).

Oxidation of Nitrogen Compounds

Oxidation of amines to promising nitro derivatives is an attractive alternative to classical nitration reaction or a Sandmeyer-type substitution reaction. Wu et al oxidized the amines based on nitrogen-rich heterocycles in a

Table 3 Comparison of three processes for the oxidation of thioether to the corresponding sulfones

No.	Instantaneous volumes (mL)	Residence time (min)	Space-time yield (mol L ⁻¹ h ⁻¹)	Conversion (%)	Product yield (%)
Batch reaction	600	75	0.68	>99	98
Two-step continuous flow	210	8.5	7.75	>99	99
Three-stream micromixing	190	6.0	8.56	>99	99

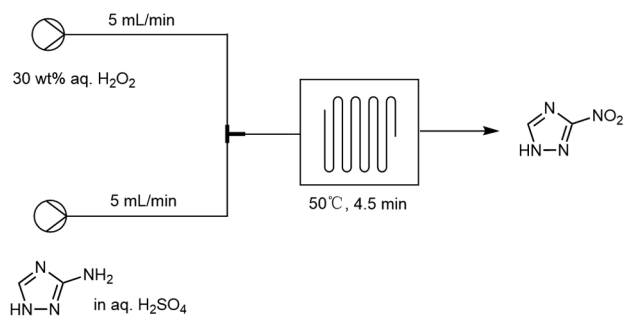
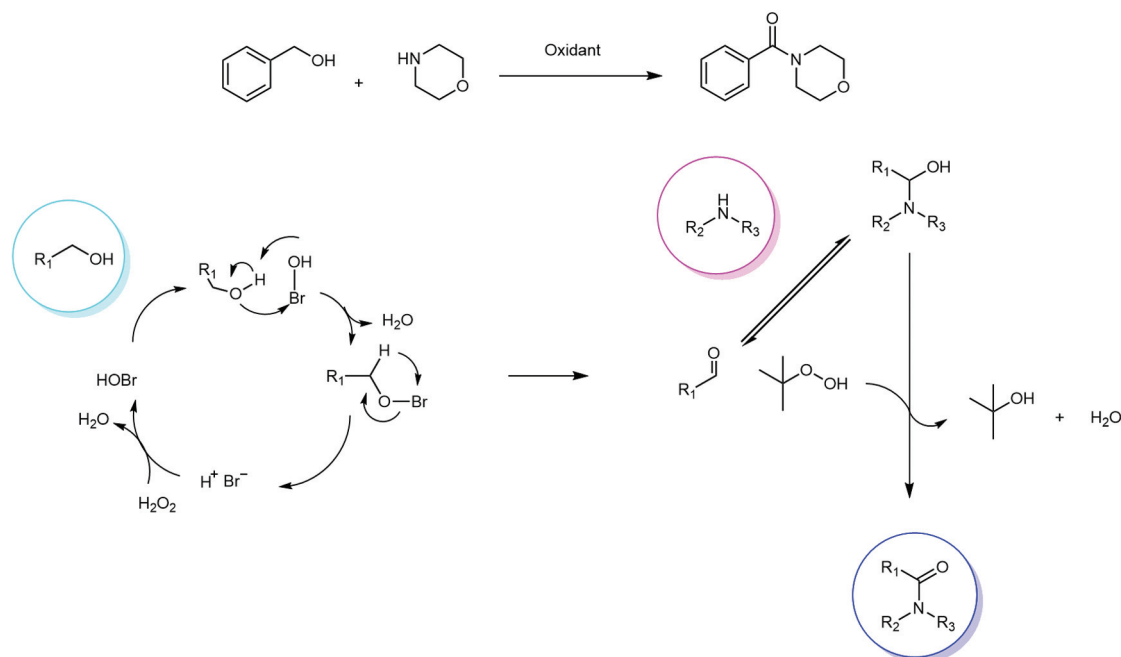

Fig. 12 Oxidation of amines in continuous flow setups.

continuous flow using H_2O_2 as an oxidant (**Fig. 12**).⁴³ The reliability of the process was confirmed by the successfully obtained 5-amino-3-nitro-1,2,4-triazole and 1-methyl-3,4,5-trinitropyrazole with a high efficiency.

Gu et al used TBHP as an oxidant and conducted a metal-free oxidative amination of aromatic alcohols in a two-step continuous flow.⁴⁴ The reaction time in continuous flow (15 minutes) was significantly shortened in comparison to a batch reaction (3 hours). The targets were produced with a yield of 86 to 96%. The mechanism is described in **Scheme 3**. Then, the group used H_2O_2 as an oxidant to further achieve a continuous-flow process of the oxidative amination of aromatic aldehydes and alcohols.⁴⁵ The process was metal-free catalysis. The continuous reaction was performed at 80°C with a feed flow rate of 0.1 mL/min , and produced 96% yield of the product at 25 minutes, which was significantly higher than a batch reaction (64% yield).



Scheme 3 Proposed mechanism of the oxidative amination of alcohol.

C–H Oxidation

C–H bond activation is a convenient method for constructing carbon–carbon bonds and carbon–heteroatom bonds with high atomic economy. Chaudhari has explored the $\text{C}(\text{sp}^3)\text{--H}$ peroxidation of 2-oxindole and barbituric acid derivatives in ethyl acetate, an eco-friendly solvent.⁴⁶ They used TBHP as an oxidant and $\text{Fe}(\text{OH})_3@Fe_3O_4$ as the catalyst to conduct a batch reaction with a yield of 81% of the product in 4 hours. To avoid the risk of explosions of organic peroxide and a long reaction time, a continuous flow process was performed, and the product successfully obtained in 75% yield in 7.9 minutes (**Fig. 13**). The catalyst could be reused up to ten times. The group also explored iron-catalyzed dehydrogenative cross-coupling of carbonyl in a continuous flow.⁴⁷ The substrate (0.1 mol/L) passed through a continuous flow reactor at a flow rate of 0.2 mL/min at 35°C to give the target product an 88% yield. This method is applied to a wide range of substrates (2-oxindole, barbituric acid, and coumarin substrates) and can be used for gram-scale synthesis.

Zhang et al presented a continuous flow technology to achieve Cu-catalyzed trifluoromethylation of coumarins under mild conditions, using inexpensive Langlois reagent ($\text{CF}_3\text{SO}_2\text{Na}$) and its partner *tert*-butyl hydroperoxide.⁴⁸ At 60°C , the reaction time was shortened from 6 hours to 50 minutes by converting the batch to a continuous flow. 7-diethylamino-4-methyl coumarin can be used as the substrate to participate in the reaction with the output of the product at 305 mg/h , suggesting the stability of the process. Furthermore, a possible mechanism is provided in **Scheme 4**.

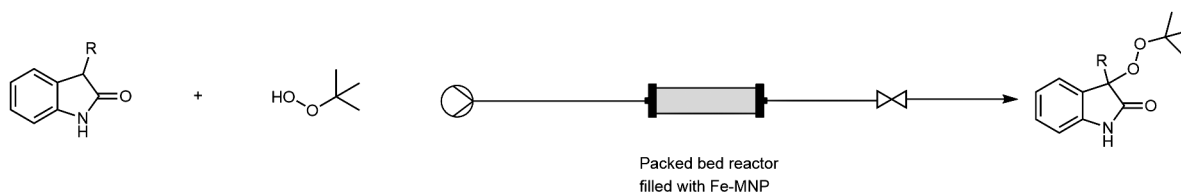
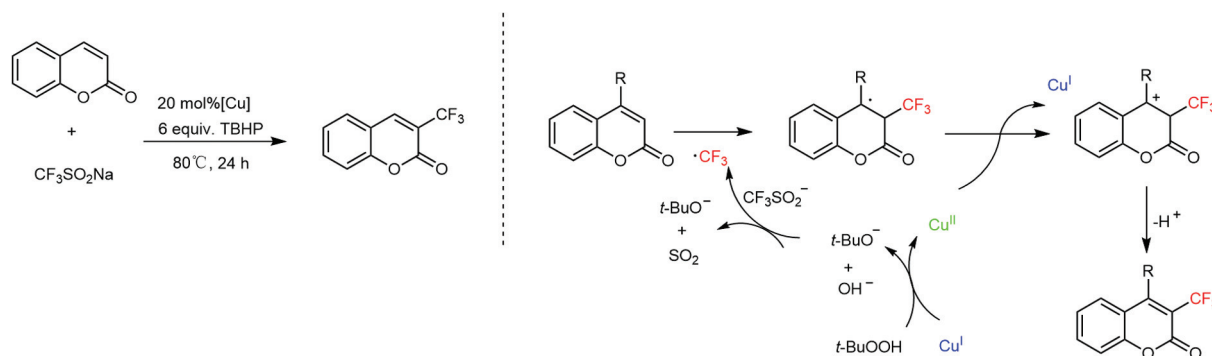

Fig. 13 Schematic representation of the continuous flow of a C(sp³)-H peroxidation reaction.



Scheme 4 Proposed mechanism for coumarin trifluoromethylation.

Peroxides in Other Organic Reactions

Traditionally, nitrile is hydrolyzed to primary amide using strong acids or bases, which may lead to excessive hydrolysis. However, Zhan et al used H₂O₂ as an oxidant for the first time to hydrolyze nitrile to primary amide in a continuous flow.⁴⁹ The conversion rate of raw materials reached 99% in 150 seconds when the reaction was performed at 2°C in a solution of phenylacetone nitrile/NaOH/H₂O₂ (1:0.375:1.2). This method has a wide substrate range and good to excellent yield. The electron-rich phenylacetone nitrile has a good yield of 81 to 99% while the electron-deficiency phenylacetone nitrile required a longer reaction time to achieve a high yield of 75 to 98%. 4-(4-Methyl-piperazine-1-yl-methyl)-benzamide, an intermediate for imatinib, was synthesized in 81% yield in the scale-up experiment (→ **Fig. 14**).

Shi et al studied a free radical reaction for the formation of amide compounds through a two-step series continuous flow reaction, using methyl aromatic, catalyst tetrabutylammonium iodide, and TBHP as raw materials.⁵⁰ Through the optimization of conditions, the two-step reaction temperature was 50°C (T1) and 80°C (T2), the residence time was 30 minutes (T1) and 33.3 minutes (T2), and the yield reached 66 to 84%. Encouragingly, under the reaction conditions, *N*-acetylprocainamide, an antiarrhythmic agent, can be obtained in 57% yield in a scale-up experiment using commercially available 4-methylacetanilide as the starting material (→ **Fig. 15**).

Al-Megren et al proposed a direct hydroxylation of benzene to phenol in the presence of H₂O₂ in a continuous membrane reactor for the first time.⁵¹ A hydrophilic membrane was used with a total feed flow rate of 2 mL/min and a stripping flow rate

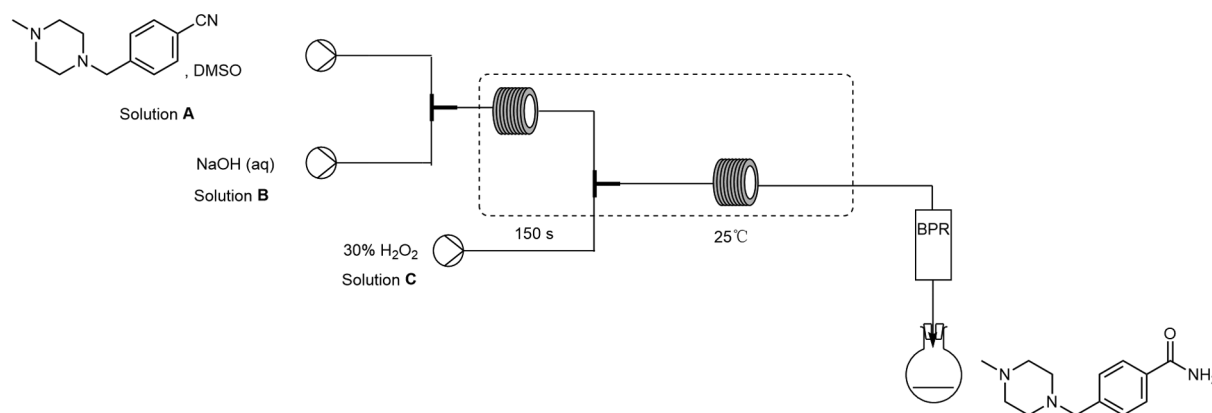

Fig. 14 A sample set-up for the flow platform for hydrolyzing nitrile to a primary amide using hydrogen peroxide as a green oxidant.

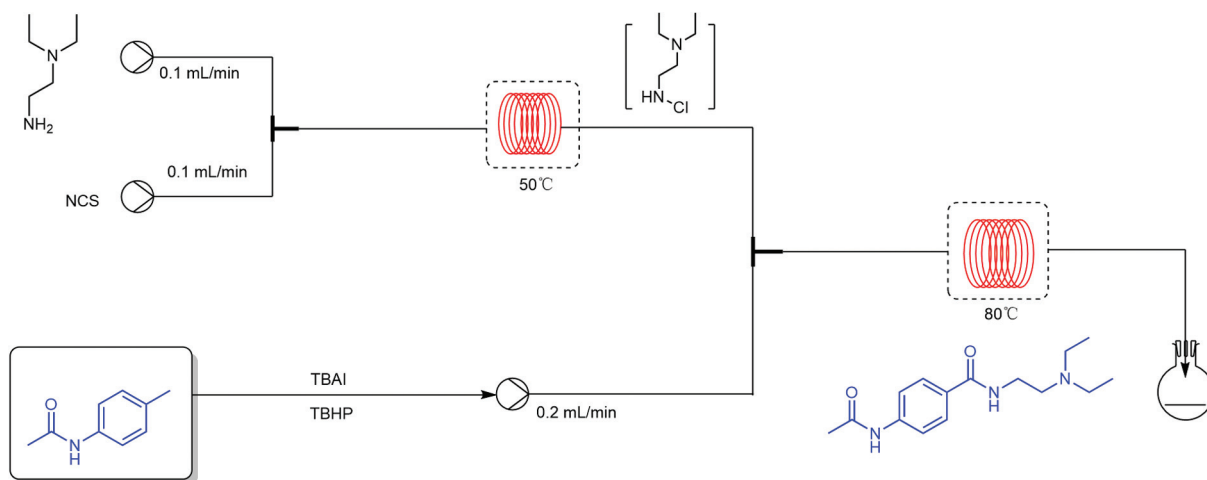
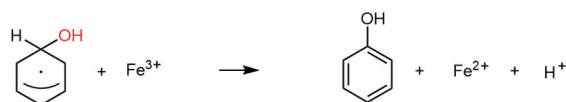
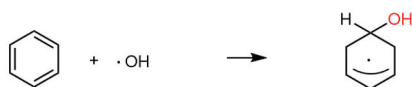

Fig. 15 A sample set-up for flow platform for the synthesis of *N*-acetylprocainamide.



Scheme 5 Proposed mechanism of the direct hydroxylation of benzene.

of 1 mL/min, resulting in a phenol recovery of 25% and a selectivity of 94%. The mechanism is provided in ► **Scheme 5**.

Conclusion

The peroxides, as green and atom-economy oxidants, are attractive alternatives to some toxic inorganic oxidants in a series of oxidation reactions. However, they tend to be explosive. The problem can be solved well in a continuous flow chemistry with the advantages of safe operation and ensuring the efficiency of the reaction. This article reviews the application of peroxides in oxidizing olefins, alcohols, aldehydes, sulfides, etc. in continuous-flow chemistry. However, the transformation of peroxide-involved reactions from batch to continuous flow still faces thorny challenges in terms of pipe blockage, advances in online analytical techniques, lack of harmonized standards, and suitable reactors. Most of the applications of peroxides in continuous flow technology remain in the laboratory stage, and the extension of continuous flow technology to production scale needs to be further explored by researchers. With the IUPAC ranking continuous flow chemistry as one of the top 10 emerging technologies in chemistry, and chemists' growing concern about the safe use of peroxides in the laboratory and chemical industry, the application of peroxides in continuous flows will be greatly explored in the future.

Funding

We are grateful to the Zhejiang Provincial Key R&D Project (Grant No. 2020C03006, 2019-ZJ-JS-03) for financial aid to this work.

Conflict of Interest

None declared.

References

- Dembitsky VM. Bioactive peroxides as potential therapeutic agents. *Eur J Med Chem* 2008;43(02):223–251
- Gandhi H, O'Reilly K, Gupta MK, Horgan C, O'Leary EM, O'Sullivan TP. Advances in the synthesis of acyclic peroxides. *RSC Advances* 2017;7(32):19506–19556
- Jones CW, Clack JH. Applications of Hydrogen Peroxide and Derivatives. Cambridge: The Royal Society of Chemistry; 1999
- Anantharaj S, Pitchaimuthu S, Noda S. A review on recent developments in electrochemical hydrogen peroxide synthesis with a critical assessment of perspectives and strategies. *Adv Colloid Interface Sci* 2021;287:102331
- Noyori R, Aoki M, Sato K. Green oxidation with aqueous hydrogen peroxide. *Chem Commun (Camb)* 2003;(16):1977–1986
- Kraïem J, Ghedira D, Ollevier T. Hydrogen peroxide/dimethyl carbonate: a green system for epoxidation of *N*-alkylimines and *N*-sulfonylimines. One-pot synthesis of *N*-alkyloxaziridines from *N*-alkylamines and (hetero)aromatic aldehydes. *Green Chem* 2016;18(18):4859–4864
- Sanderson WR. Cleaner industrial processes using hydrogen peroxide. *Pure Appl Chem* 2000;72:1289–1304
- Qian Y, Xu W, Zhan JH, Jia X, Zhang F. Atomic insights into the thermal runaway process of hydrogen peroxide and 1,3,5-trimethylbenzene mixture: Combining ReaxFF MD and DFT methods. *Process Saf Environ Prot* 2021;147:578–588
- ten Brink GJ, Arends IW, Sheldon RA. The Baeyer-Villiger reaction: new developments toward greener procedures. *Chem Rev* 2004;104(09):4105–4124
- Martin B, Sedelmeier J, Bouisseau A, et al. Toolbox study for application of hydrogen peroxide as a versatile, safe and industrially-relevant green oxidant in continuous flow mode. *Green Chem* 2017;19(06):1439–1448
- Fülöp Z, Szemesi P, Bana P, Éles J, Greiner I. Evolution of flow-oriented design strategies in the continuous preparation of pharmaceuticals. *React Chem Eng* 2020;5(09):1527–1555

- 12 Dallinger D, Gutmann B, Kappe CO. The concept of chemical generators: on-site on-demand production of hazardous reagents in continuous flow. *Acc Chem Res* 2020;53(07):1330–1341
- 13 Su W, Yu Z. Development and application of continuous-flow technology in pharmaceutical hazardous processes. *Chung Kuo Yao Hsueh Tsa Chih* 2017;48(04):469–482
- 14 Targhan H, Evans P, Bahrami K. A review of the role of hydrogen peroxide in organic transformations. *J Ind Eng Chem* 2021; 104:295–332
- 15 Olivo G, Cussó O, Borrell M, Costas M. Oxidation of alkane and alkene moieties with biologically inspired nonheme iron catalysts and hydrogen peroxide: from free radicals to stereoselective transformations. *Eur J Biochem* 2017;22(2–3):425–452
- 16 Freakley SJ, Piccinini M, Edwards JK, Ntainjua EN, Moulijn JA, Hutchings GJ. Effect of reaction conditions on the direct synthesis of hydrogen peroxide with a AuPd/TiO₂ catalyst in a flow reactor. *ACS Catal* 2013;3(04):487–501
- 17 Maralla Y, Sonawane S. Process intensification using a spiral capillary microreactor for continuous flow synthesis of performic acid and its kinetic study. *Chem Eng Process* 2018;125:67–73
- 18 Gaikwad SM, Jolhe PD, Bhanvase BA, et al. Process intensification for continuous synthesis of performic acid using Corning advanced-flow reactors. *Green Process Synth* 2017;6(02):189–196
- 19 Katuri P, Maralla YSS, Tumma BN. Production of performic acid through a capillary microreactor by heterogeneous catalyst. *Int J Chem React Eng* 2023;21(01):1–9
- 20 Jolhe PD, Bhanvase BA, Patil VS, Sonawane SH. Sonochemical synthesis of peracetic acid in a continuous flow micro-structured reactor. *Chem Eng J* 2015;276:91–96
- 21 Maralla Y, Sonawane S. Comparative study for production of unstable peracetic acid using microstructured reactors and its kinetic study. *J Flow Chem* 2019;9(02):145–154
- 22 Li B, Guinness SM, Hoagland S, et al. Continuous production of anhydrous tert-butyl hydroperoxide in nonane using membrane pervaporation and its application in flow oxidation of a γ -butyrolactam. *Org Process Res Dev* 2018;22(06):707–720
- 23 Okuno Y, Kitagawa Y, Kamiya S, et al. Triphasic continuous-flow oxidation system for alcohols utilizing graft-polymer-supported TEMPO. *Asian J Org Chem* 2018;7(06):1071–1074
- 24 Kon Y, Nakashima T, Yada A, et al. Pt-Catalyzed selective oxidation of alcohols to aldehydes with hydrogen peroxide using continuous flow reactors. *Org Biomol Chem* 2021;19(05):1115–1121
- 25 Kon Y, Nakashima T, Onozawa SY, Sato K, Kobayashi S. Switchable synthesis of aldehydes and carboxylic acids from alcohols by platinum-catalysed hydrogen peroxide oxidation using flow reactors. *Adv Synth Catal* 2022;364(19):3372–3377
- 26 Liu C, Fang Z, Yang Z, et al. Highly practical oxidation of benzylic alcohol in continuous-flow system with metal-free catalyst. *Tetrahedron Lett* 2015;56(44):5973–5976
- 27 Derikvand F, Bigi F, Maggi R, Piscopo CG, Sartori G. Oxidation of hydroquinones to benzoquinones with hydrogen peroxide using catalytic amount of silver oxide under batch and continuous-flow conditions. *J Catal* 2010;271(01):99–103
- 28 Li J, Lin W, Shao Y, et al. Synthesis of 2,3,5-trimethylbenzoquinone from 2,3,6-trimethylphenol and tert-butyl hydroperoxide in microreactors. *J Flow Chem* 2022;12(02):219–226
- 29 Prieschl M, Ötvös SB, Kappe CO. Sustainable aldehyde oxidations in continuous flow using in situ-generated performic acid. *ACS Sustain Chem Eng* 2021;9(16):5519–5525
- 30 Ötvös SB, Llanes P, Pericàs MA, Kappe CO. Telescoped continuous flow synthesis of optically active gamma-nitrobutyric acids as key intermediates of baclofen, phenibut, and fluorophenibut. *Org Lett* 2020;22(20):8122–8126
- 31 Limnios D, Kokotos CG. 2,2,2-Trifluoroacetophenone: an organo-catalyst for an environmentally friendly epoxidation of alkenes. *J Org Chem* 2014;79(10):4270–4276
- 32 Yuan WQ, Zhou SQ, Jiang YY, Li HH, Zheng HD. Organocatalyzed styrene epoxidation accelerated by continuous-flow reactor. *J Flow Chem* 2020;10(01):227–234
- 33 Mohammed ML, Mbeleck R, Saha B. Efficient and selective molybdenum based heterogeneous catalyst for alkene epoxidation using batch and continuous reactors. *Polym Chem* 2015;6(41):7308–7319
- 34 Tibbetts JD, Cunningham WB, Vezzoli M, Plucinski P, Bull SD. Sustainable catalytic epoxidation of biorenewable terpene feedstocks using H₂O₂ as an oxidant in flow microreactors. *Green Chem* 2021;23(15):5449–5455
- 35 Bassindale MJ, Hamley P, Harray JPA. Employment of a cyclo-butene ring-opening metathesis reaction towards a concise synthesis of (+/-)-sporochinol A. *Tetrahedron Lett* 2001;42(51): 9055–9057
- 36 Souto JA, Stockman RA, Ley SV. Development of a flow method for the hydroboration/oxidation of olefins. *Org Biomol Chem* 2015;13 (13):3871–3877
- 37 Wen Y, Wang X, Wei H, Li B, Jin P, Li L. A large-scale continuous-flow process for the production of adipic acid via catalytic oxidation of cyclohexene with H₂O₂. *Green Chem* 2012;14(10):2868–2875
- 38 Shang M, Noël T, Wang Q, Hessel V. Packed-bed microreactor for continuous-flow adipic acid synthesis from cyclohexene and hydrogen peroxide. *Chem Eng Technol* 2013;36(06):1001–1009
- 39 Maggi R, Chitsaz S, Loebbecke S, Piscopo CG, Sartori G, Schwarzer M. Highly chemoselective metal-free oxidation of sulfides with diluted H₂O₂ in a continuous flow reactor. *Green Chem* 2011;13 (05):1121
- 40 Mangiavacchi F, Crociani L, Sancineto L, Marini F, Santi C. Continuous bioinspired oxidation of sulfides. *Molecules* 2020;25(11):2711
- 41 Doherty S, Knight JG, Carroll MA, et al. Efficient and selective hydrogen peroxide-mediated oxidation of sulfides in batch and segmented and continuous flow using a peroxometalate-based polymer immobilised ionic liquid phase catalyst. *Green Chem* 2015;17(03):1559–1571
- 42 Zhang Q, Yan D, Li L, et al. Continuous process for preparation of 2,3-dimethyl-4-methylsulfonylbromobenzene via oxidation by in situ formed peracetic acid. *Chem Eng Process* 2023;184:109205
- 43 Wu B, Jiang X, Yang Y, et al. Continuous-flow oxidation of amines based on nitrogen-rich heterocycles: a facile and sustainable approach for promising nitro derivatives. *Org Process Res Dev* 2022;26(10):2823–2829
- 44 Gu J, Fang Z, Liu C, et al. A two-step continuous flow synthesis of amides from alcohol using a metal-free catalyst. *RSC Advances* 2015;5(115):95014–95019
- 45 Gu J, Fang Z, Liu C, Li X, Wei P, Guo K. Direct oxidative amination of aromatic aldehydes with amines in a continuous flow system using a metal-free catalyst. *RSC Advances* 2016;6(76):72121–72126
- 46 Chaudhari MB, Mohanta N, Pandey AM, Vandana M, Karmodiya K, Gnanaprakasam B. Peroxidation of 2-oxindole and barbituric acid derivatives under batch and continuous flow using an eco-friendly ethyl acetate solvent. *React Chem Eng* 2019;4(07):1277–1283
- 47 Chaudhari MB, Moorthy S, Patil S, et al. Iron-catalyzed batch/continuous flow C-H functionalization module for the synthesis of anticancer peroxides. *J Org Chem* 2018;83(03):1358–1368
- 48 Zhang X, Huang P, Li Y, Duan C. A mild and fast continuous-flow trifluoromethylation of coumarins with the CF₃ radical derived from CF₃SO₂Na and TBHP. *Org Biomol Chem* 2015;13(44):10917–10922
- 49 Zhan W, Ji L, Ge ZM, Wang X, Li RT. A continuous-flow synthesis of primary amides from hydrolysis of nitriles using hydrogen peroxide as oxidant. *Tetrahedron* 2018;74(13):1527–1532
- 50 Shi T, Zhang Z, Yang Y, et al. Two-step continuous flow synthesis of amide via oxidative amidation of methylarene. *Tetrahedron* 2020;76(13):131044
- 51 Al-Megren HA, Poerio T, Brunetti A, et al. Liquid phase benzene hydroxylation to phenol using semi-batch and continuous membrane reactors. *Separ Purif Tech* 2013;107:195–203