

8th Annual Oxford International Conference on the Science of Botanicals

Date/Place: April 6–9, 2009, University of Mississippi, University, MS, USA

Chairman and Issue Editor: Ikhlas Khan
Issue Co-Editors: Troy Smillie, Shabana Khan



The
University of Mississippi

Oxford • Jackson • Tupelo • Southaven

April 6, 2009

Dear Friends,

On behalf of the National Center for Natural Products Research, School of Pharmacy, and the University of Mississippi, we would like to welcome you to our conference entitled "8th International Conference on the Science of Botanicals" This conference is supported through a cooperative agreement between the NCNPR and the Center for Food Safety and Applied Nutrition (CFSAN) of the Food and Drug Administration. Co-sponsors are: CFSAN/FDA, Shanghai Institute of Material Medica/CAS, China; The Council of Scientific and Industrial Research (CSIR-India); the Society for Medicinal Plant Research (GA); Institute of Indigenous Medicine (IIM), Sri Lanka, and the American Society of Pharmacognosy (ASP).

We are excited to present a program featuring a roster of internationally recognized experts and researchers in the field of botanicals. We wish to extend our thanks to our speakers for their willingness to participate in and contribute to the success of the meeting.

We invite you to visit the website of the National Center for Natural Products Research at <http://www.pharmacy.olemiss.edu/ncnpr> to learn more about our research program. Oxford and the Ole Miss campus are a beautiful setting, and we hope you will get to explore them, especially if this is your first time to visit here. If there is anything we can do to make your visit more enjoyable, please contact us.

Sincerely,

Larry A. Walker, Ph.D.

Director
National Center for Natural Products Research

Ikhlas A. Khan, Ph.D.

Director of FDA Program
National Center for Natural Products Research

Advisory Committee

Alice M. Clark, Ph.D.
Vice Chancellor for Research
and Sponsored Programs,
The University of Mississippi

Larry A. Walker, Ph.D.
Director, NCNPR,
The University of Mississippi

Organizing Committee

Rudolf Bauer, Ph.D.
Institute of Pharmaceutical Sciences,
Department of Pharmacognosy,
Karl-Franzens-Universität Graz

Joseph M. Betz, Ph.D.
Office of Dietary Supplements of NIH

Shaw T. Chen, M.D., Ph.D.
Associate Director, ODE-V, CDER, FDA

Steven Dentali, Ph.D.
Vice President, Scientific
and Technical Affairs,
American Herbal Products Association

De-an Guo, Ph.D.
Director, Shanghai Research Center
for TCM Modernization,
Shanghai Institute of Materia Medica/CAS

Ikhlas Khan, Ph.D.
Director of FDA Program, Assistant Director
NCNPR, The University of Mississippi

Brigitte Kopp, Ph.D.
Professor of Pharmacognosy,
Department of Pharmacognosy,
University of Vienna, Austria

Steven Musser, Ph.D.
Director, Office of Regulatory Science,
CFSAN, FDA

G. N. Qazi, Ph.D.
CRISM, India

Troy Smillie, Ph.D.
Research Scientist, NCNPR,
The University of Mississippi

Scientific Program Committee

John Cardellina II, Ph.D.
Reeves Group

K. Hüsnü C. Baser, Ph.D.
Professor, Head of the Department
of Pharmacognosy,
Anadolu University, Eskisehir, Turkey

Mark Blumenthal
Executive Director,
American Botanical Council

Paul Pui-Hay But, Ph.D.
Dept. of Biology and Institute
of Chinese Medicine, Chinese University
of Hong Kong Shatin, N. T.

Elizabeth M. Calvey, Ph.D.
Team Leader, Liaison and Partnership Team,
CFSAN, FDA

Edward Croom Jr., Ph.D.
Adjunct Associate Professor, Pharmacog-
nosy, The University of Mississippi

Stephen J. Cutler, Ph.D.
Chair and Professor of Medicinal Chemistry,
The University of Mississippi

Stephen O. Duke, Ph.D.
Research Leader, USDA, ARS, NPURU,
NCNPR, The University of Mississippi

Mahmoud A. ElSohly, Ph.D.
Research Professor NCNPR,
Professor of Pharmaceutics,
The University of Mississippi

Daneel Ferreira, Ph.D.
Chair and Professor of Pharmacognosy,
The University of Mississippi

Edward J. Fletcher
COO/Botanicals Division,
Strategic Sourcing, Inc.

Vasilios (Bill) Frankos, Ph.D.
Director, Division of Dietary Supplement
Programs, ONPLDS, CFSAN, FDA

Mahabir P. Gupta, Ph.D.
Director, Centro de Investigaciones
Farmacognósticas de la Flora Panameña
(CIFLORPAN)

Loren Israelsen, J.D.
Executive Director,
United Natural Products Alliance

A. Douglas Kinghorn, Ph.D., D.Sc.
Jack L. Beal Professor and Chair, Division
of Medicinal Chem. & Pharmacognosy,
Ohio State University, College of Pharmacy

Susan Manly, Ph.D.
Manager of Discovery Screening
and Informatics, NCNPR,
The University of Mississippi

Rachel Mata, Ph.D.
Department of Pharmacy,
National Autonomous University of Mexico

Robin J. Marles, Ph.D.
Director, Bureau of Clinical Trials
and Health Science, NHPD, Health Products
and Food Branch, Health Canada

James McChesney, Ph.D.
Tapestry Pharmaceuticals, Inc.

Jim Miller, Ph.D.
Dean & Vice President for Science,
The New York Botanical Garden

Nicholas Oberlies, Ph.D.
Research Triangle Institute

David S. Pasco, Ph.D.
Assistant Director, NCNPR,
The University of Mississippi

Guido F. Pauli, Ph.D.
Assistant Professor of Pharmacognosy,
University of Illinois at Chicago

Jeanne Rader, Ph.D.
Director, Division of Research and Applied
Technology, ONPLDS, CFSAN, FDA

Roy Upton
Executive Director,
American Herbal Pharmacopoeia

Aruna Weerasooriya, Ph.D.
Research Scientist, NCNPR,
The University of Mississippi

Invited Speakers

A. P. G. Amarasinghe, Ph.D.
Institute of Indigenous Medicine, Sri Lanka

Rudolf Bauer, Ph.D.
University of Graz

Mike Balick, Ph.D.
New York Botanical Garden

Y. S. Bedi, Ph.D.
Institute of Integrative Medicine (CSIR),
Jammu Tawi, India

Amy Boileau, Ph.D.
Regulatory and Scientific Affairs, Cargill

Josef Brinckmann
Traditional Medicinals

Paula Brown, M.Sc., MCIC
British Columbia Institute of Technology

Paul Pui-Hay But, Ph.D.
Yunnan Institute of Materia Medica,
Yunnan, China.

Shi-lin Chen, Ph.D.
Institute of Medicinal Plant Research, China

Wan-sheng Chen, Ph.D.
School of Pharmaceutical Sciences,
Second Military University, China

Muhammad Iqbal Choudhary, Ph.D.
University of Karachi, Pakistan

Jinhui Dou, Ph.D.
CDER/FDA

Thomas Efferth, Ph.D.
German Cancer Research Center

René Roth-Ehrang, Ph.D.
Finzelberg GmbH & Co. KG

Norman Farnsworth, Ph.D.
Department of Medicinal Chemistry
and Pharmacognosy, UIC

Vasilios H. Frankos, Ph.D.
CFSAN/FDA

Gabriel I. Giancaspro, Ph.D.
United States Pharmacopoeia

De-an Guo, Ph.D.
Shanghai Institute of Materia Medica,
CAS, China

Pierre S. Haddad, Ph.D.
University of Montreal

Loren Israelsen, J.D.
United Natural Products Alliance

Yi Jiang, Ph.D.
Suzhou Yihua Biomedical Technology Co. Ltd.

Mohammad Kamil, Ph.D.
Zayed Complex of Herbal Research
and Traditional Medicine, UAE

Hon. Tissa Karaliyadde
Minister of Indigenous Medicine, Sri Lanka

Rick Kingston, PharmD
SafetyCall™ International

M. W. S. J. Kumari, Ph.D.
Institute of Indigenous Medicine, Sri Lanka

Victoria Kyeyune
Health Canada Natural Health Products
Directorate

Ping Li, Ph.D.
China Pharmaceutical University

Rui Chao Lin, Ph.D.
Department of Chinese Materia Medica
and Natural Products

Ai-Ping Lu, Ph.D.
Institute of Basic Theory, China Academy of
Traditional Chinese Medicine, Beijing, China

Guo-An Luo, Ph.D.
Tsinghua University, China

Muhammed Majeed, Ph.D.
Sami Labs Ltd., Bangalore, India

Michael McGuffin
American Herbal Products Association

Jim Miller, Ph.D.
New York Botanical Garden

Susan Murch, Ph.D.
University of British Columbia

Luc Pieters, Ph.D.
University of Antwerp

Carol H. Pontzer, Ph.D.
Chief Natural Products Branch, NCCAM

G. N. Qazi, Ph.D.
CRISM, India

Zhong Zhi Qian, Ph.D.
Chinese Pharmacopoeia Commission

Eike Reich, Ph.D.
CAMAG Laboratory

Tatiana Syrovets, Ph.D.
University of Ulm

Michael Schwarz, Ph.D.
PhytoLab GmbH & Co. KG

Hermann Stuppner, Ph.D.
University of Innsbruck

S. C. Taneja, Ph.D.
Indian Institute of Integrative Medicine
(CSIR)

Peng-fei Tu, Ph.D.
Peking University Health Science
Center, China

Padma Venkata, Ph.D.
Joint Director FRLHT

Rob Verpoorte, Ph.D.
University of Leiden

Arnold Vlietinck, Ph.D.
University of Antwerp

Shi-Lin Yang, Ph.D.
Medical College of Soochow University,
Suzhou, China

Jun Yin, Ph.D.
Shenyang Pharmaceutical University,
China

Shi-shan Yu, Ph.D.
Chinese Academy of Medical Sciences

Yu-Qing Zhao, Ph.D.
School of Traditional Chinese Materia
Medica, Shenyang Pharmaceutical
University, Shenyang, China

Oral Presentations – In order of appearance

Keynote Speaker

Trials and Tribulations of Planning and Conducting a Phase 2 Clinical Trial with Black Cohosh and Red Clover

Farnsworth NR¹

¹ UIC/NIH Center for Botanical Dietary Supplements Research, College of Pharmacy, University of Illinois at Chicago

A Phase 2 clinical trial with Black Cohosh and Red Clover was conceived in 2000 within our UIC/NIH Center for Botanical Dietary Supplement Research on Women's Health. Prior to implementing the trial, a Phase 1 study was required and approval from FDA that an IND application was not required since the end point being measured was reduction in hot flashes in menopausal women. Menopause, for purposes of FDA is not considered a disease. The study was delayed for more than a year in order to prepare a botanically authenticated and chemically and biologically standardized extract. It was ascertained that the biological endpoint for purposes of the study would be interaction with certain serotonin receptors, *in vitro*. The study preparations had to be formulated and were subjected to accelerated stability studies. During the recruitment of suitable subjects the results of the WHI (Women's Health Initiative) caused difficulty in the ability to recruit suitable women since the study had four arms, i.e. Black Cohosh, Red Clover, Placebo and Prempro and many women were reluctant to enter the trial if there was a possibility that there would be taking Prempro. Because of this, only 88 subjects were recruited of the 128 initially planned. However, the study was powered sufficiently if the dropout rate was less than 15%. In the final analysis, Red Clover was shown to positively affect cognition but neither test preparation reduced hot flashes. A discussion of these results will be presented.

S-2

Botanicals and NMR-based Metabolomics: A Perfect Holistic Match

Verpoorte R¹, Choi YH, Choi HK

¹ Department of Pharmacognosy, Section Metabolomics, Institute of Biology Leiden, PO Box 9502, 2300RA Leiden, The Netherlands, Email: VERPOORT@LACDR.LeidenUniv.nl

An estimated 40,000–70,000 plant species are used as medicines worldwide. Some of these are extensively studied and their use is supported by clear clinical evidence. But in fact most have not been studied in any detail, and little is known about their activity, mode

of action and possible active compounds. This poses two major problems, one is the acceptance of botanicals that are not yet evidence-based, the other is quality control. In fact acceptance is hampered by the fact that no methods for proper quality control are available if no active compound(s) is/are known. With globalization the use of botanicals is clearly increasing. Pharmacognosy has thus a major task in developing medicinal plants into evidence-based medicines. This will include both mentioned aspects: evidence for activity and quality control. In the past decades drug development has gone from *in-vivo* testing into molecular based assays (High Throughput Screening, HTS) for finding new leads. Certainly by HTS one may find active compounds in medicinal plants, but synergy and pro-drugs will certainly not be found in such an approach. We pharmacognosists should thus rethink our approaches for proving activity of medicinal plants. This is where systems biology and metabolomics do offer interesting options. It means going back to *in-vivo* pharmacology in combination with the “-omics” technologies to measure the response of a test organism on treatment with the medicinal plant, and metabolomics to phytochemically characterize the medicinal plant. By chemometric methods, such as multivariate analysis, links can be made between compounds present in the plant and activities observed in the model organism. That means that not only active compounds, but also synergy and pro-drugs can be found. This approach will also be the basis for quality control. By using metabolomics in combination with multivariate analysis one can define the required profile for activity. Particularly NMR-based metabolomics has a great potential for both quality control and identification of compounds related to activity.

S-3

Evaluation of the Anti-inflammatory Potential of Chinese Botanicals

Bauer R¹, Adams M, Fischer M, Gusenleitner S, Schühly W

¹ Institute of Pharmaceutical Sciences, Department of Pharmacognosy, Karl-Franzens-University Graz, Universitätsplatz 4, 8010 Graz, Austria

Traditional Chinese medicine (TCM) has been using about 1300 plants for anti-inflammatory purposes. Activity guided isolation in a medium throughput approach has resulted in the discovery of a number of new drug leads. From the fruits of *Evodia rutaecarpa* (Juss.) Benth. (Rutaceae), several quinolinone alkaloids, like 1-methyl-2-nonyl-4(1H)-quinolinone, 1-methyl-2-(6Z)-6-undecenyl-4(1H)-quinolinone, 1-methyl-2-(4Z,7Z)-4,7-tridecadienyl-4(1H)-quinolinone, evo-carpine and 1-methyl-2-(6Z,9Z)-6,9-pentadeca-

dienyl-4(1H)-quinolinone, have been isolated which showed strong inhibitory activity on leukotriene biosynthesis in human polymorphonuclear granulocytes [1]. They showed no cytotoxic activity and might bind to the lipid binding site of 5-LOX [2]. Moreover they were very effective against mycobacteria [3]. From *Centipeda minima* (L.) A. Braun & Asch. (Asteraceae) a series of sesquiterpene lactones, like 6-O-methylacrylplenolin, 6-O-angeloylplenolin and 6-O-tigloyl-pnenolin, have been isolated, which exhibited strong inhibitory properties on inducible nitric oxide synthase (iNOS) in RAW 264.7 macrophages [4]. Extracts from Chinese herbs have shown inhibitory properties on expression of NF- κ B1 in THP-1 cells [5]. Overexpression of this transcription factor is associated with inflammatory diseases, like rheumatoid arthritis, atherosclerosis, asthma and inflammatory bowel disease. Sesquiterpenes, like parthenolide and helenalin have been demonstrated to be responsible for that effect [6]. **Acknowledgements:** Part of the work has been supported by Zukunftsfonds Styria ("TCM Research Center Graz"). **References:** [1] Adams M, et al. (2004) *Planta Med.* 70: 904–908. [2] Adams M, et al. (2007) *Planta Med.* 73: 1554–1557. [3] Adams M, et al. (2005) *Int. J. Antimicrob. Agents* 26(3): 262–264. [4] Fischer M, et al. (2009) in preparation. [5] Gusenleitner S, Bauer R, (2007) *Planta Med.* 73: 844. [6] Gusenleitner S, et al. (2009) in preparation.

S-5

Ethnobotany, Traditional Medicine and Dietary Supplements: Research Priorities and Lessons to be Learned

Balick MJ¹

¹ Institute of Economic Botany, The New York Botanical Garden, Bronx, New York 10458, U.S.A.

There are estimated to be 420,000 species of higher plants on earth, about half of which are found in the tropics. Over millennia, people have learned to use plants to sustain their lives. Ethnobotany is a science that studies the relationship between plants, people and traditional culture. This presentation discusses the study of plants used in traditional healing, with examples from Belize, Central America, The Pacific Island region of Micronesia, and New York City by a Dominican immigrant community. Traditional knowledge in many parts of the world, including our own, has "devolved", or disappeared when its practitioners die without teaching the knowledge to the next generation. The implications of this for natural products research and development and safe and proper use of new plant species as dietary supplements will be discussed. Herbs used by traditional peoples have been subjected to many generations, even centuries of trial and error experimentation, and there is much that these people can teach us about their efficacy and use. Ethnobotanical knowledge can be of great value in addressing contemporary issues in supplement and drug development, public health and sustainable resource use and conservation. However, in seeking to fulfill this potential, scientists find themselves in a race against time, with both habitats being destroyed and indigenous knowledge about the uses of the plants and their environment rapidly being lost. There are ways to reduce this destruction of humanity's collective wisdom before it is too late.

S-6

Known Natural Products with Unknown Bioactivity

Schwaiger S¹, Rollinger JM¹, Stuppner H¹

¹ Institute of Pharmacy/Pharmacognosy, University of Innsbruck, 6020 Innsbruck, Austria

To date more than 170,000 natural compounds [1, 2] are published. The main part of these compounds belongs to secondary metabolites, which provide living systems with their characteristic features mandatory for surviving. They contain an inherently large-scale of structural diversity. About 40% of the chemical scaffolds of published natural products (NPs) are unique and have not been synthesized by any chemist [3]. Accordingly, a large number of drug leads and hits are conserved in the inexhaustible pool of NPs pre-screened by evolution. But how to dig out and to recognize the respective drug leads is a challenging task. Although a random selec-

tion of plant materials seems not to be a very efficient strategy for the discovery of new biologically active compounds, many today well-known natural drug leads are based on a serendipitous finding. An example of a successful random study will be presented from our laboratory, which has recently resulted in the identification of isogentisin, a secondary metabolite of *Gentiana lutea* L., as a novel compound for the prevention of smoking-caused endothelial injury [4]. A more rationalized access to bioactive compounds is offered by *in silico* tools e.g. pharmacophore-based virtual screening, docking experiments and the parallel screening concept. Screening of compounds against a set of models representing a large number of targets aims to predict the pharmacological profiles of these molecules including desirable activities and undesirable effects. In this presentation an example application employing a virtual parallel screening approach with a collection of 2208 in-house generated pharmacophore models on constituents of the aerial parts of the medicinal plant *Ruta graveolens* L. will be illustrated [5]. **References:** [1] Dictionary of Natural Products provided by Chapman & Hall/CRC: <http://www.chemnetbase.com/tours/dnp/index.html>. [2] Tulp M, et al. (2005) *Bioorg. Med. Chem.*, 13: 5274–5282. [3] Henkel T, et al. (1999) *Angew Chem. Int. Ed.*, 38: 643–647. [4] Schmieder A, et al. (2007) *Atherosclerosis*, 194: 317–325. [5] Rollinger JM, et al. (2009) *Planta Med.* in press.

S-7

Antimalarial Agents from Plants: Neocryptolepine Derivatives and Standardised Extracts from Traditional Medicine

Pieters L¹

¹ Laboratory of Pharmacognosy and Pharmaceutical Analysis, University of Antwerp, Universiteitsplein 1, 2610 Antwerp, Belgium

Plants are still an important resource for the discovery of new drugs, such as new antimalarial agents. In search for novel antimalarial compounds, we focused on neocryptolepine (5-methyl-5H-indolo[2,3-b]quinoline), one of the minor alkaloids of *Cryptolepis sanguinolenta*, a plant used in traditional medicine in Central and West Africa. A series of chloro- and aminoalkylamino-substituted neocryptolepine derivatives were synthesized and evaluated as antiplasmodial agents. The evaluation included cytotoxicity (MRC5 cells), inhibition of β -hematin formation and DNA-interactions (DNA/methyl green assay). Introduction of aminoalkylamino chains increased the antiplasmodial activity of the neocryptolepine core substantially. The most active compounds showed antiplasmodial activities in the nM range. Nevertheless, some compounds that were selected for *in vivo* evaluation in infected mice were not sufficiently active, or toxic to the animals. A different approach to develop antimalarial drugs from nature is the standardisation of plant extracts with a proven efficacy used in traditional medicine. *Nauclea pobeguinii* (Rubiaceae) is a tree from which the bark is widely used in African traditional medicine against malaria-like symptoms. Alkaloids such as the major compound strictosamide are expected to be responsible for the activity. An HPLC method was developed and validated for the quantification of strictosamide in an 80% EtOH extract of the stem bark of *N. pobeguinii*. This extract, containing 5.6% (w/w) strictosamide, was evaluated *in vivo* in the *Plasmodium berghei* mouse model in a suppressive treatment regimen. It was orally dosed (PO) at 300 mg/kg 2 \times /day during 5 consecutive days. Another group was treated intraperitoneally (IP) at 50 mg/kg using the same dosing regimen. Treatment with the crude extract, either after oral or intraperitoneal dosing, resulted in moderate depression of parasitaemia during dosing, however quickly followed by a full relapse (mean survival time = about 13 days). At termination of the experiment at day 21, a single survivor in the PO group was apparently cured (no parasitaemia), the single survivor in the IP group showed high parasitaemia and was in a moribund state. It can be concluded that the crude extract of *N. pobeguinii* has slight antimalarial potential when administered orally in a suppressive dosing regimen of 2 \times 5 days at 300 mg/kg. Longer treatment may be necessary.

S-8

Triterpenoids as Anti-inflammatory Compounds of Natural Origin

Syrovets T¹, Rouis M¹, Simmet T¹

¹ Institute of Pharmacology of Natural Products and Clinical Pharmacology, University of Ulm, Helmholtzstr. 20, D-89081 Ulm, Germany

Despite the progress in understanding the molecular mechanisms underlying chronic inflammation, the current treatment options are not satisfactory. The transcription factor NF- κ B, a key player in the development and progression of chronic inflammation, is considered a promising target for therapeutic intervention. In Ayurvedic medicine, extracts from the oleogum resin from *Boswellia serrata* are being used as anti-inflammatory remedies. After purification to chemical homogeneity, we have identified a number of pentacyclic triterpenoids including acetyl-boswellic acids (ABAs). Using LPS as an activator of human monocytes, we found that ABAs inhibit NF- κ B signaling. We identified specific inhibitory effects on I κ B kinase (IKK), which is pivotal for the degradation of the NF- κ B inhibitor I κ B, as well as the phosphorylation of p65, two steps essential for NF- κ B activation and the subsequent cytokine expression. Using active human recombinant IKK α and IKK β , we positively confirmed the direct effect of the ABAs on the IKK complex. We further studied the effects of systemically applied AK β BBA on the development of atherosclerotic lesions in apolipoprotein E-deficient (apoE^{-/-}) mice. Atherosclerotic lesion formation was accelerated in those animals by weekly intraperitoneal lipopolysaccharide (LPS) injections. LPS alone increased the atherosclerotic lesion size by two-fold and treatment with AK β BBA significantly reduced it by about 50%. Daily treatment of the mice with AK β BBA potently inhibited the NF- κ B activation in atherosclerotic plaques and led to significant down-regulation of several NF- κ B-dependent genes such as MCP-1, MCP-3, IL-1 α , MIP-2, VEGF and TF. By contrast, AK β BBA did not affect the plasma concentrations of triglycerides, total cholesterol, and various subsets of lymphocyte-derived cytokines. Thus, the inhibition of NF- κ B signalling by constituents of the oleogum resins from *Boswellia* species might represent an alternative for conventional treatments of chronic inflammatory diseases such as atherosclerosis. **Acknowledgements:** This work was supported by the Deutsche Krebshilfe.

S-9

Scientific Studies of a Popular Sri Lankan Indigenous Therapeutic Agent Rathakalka Used in Pediatric Practice

Amarasinghe APG¹

¹ Institute of Indigenous Medicine, University of Colombo, Rajagiriya, Sri Lanka

The test drug Rathakalka, selected for these studies, is a popular Sri Lankan indigenous medical recipe specially used for children. A clinical study of the Rathakalka recipe revealed significant changes in serum immunoglobulins (IgG, IgM, and IgA) and serum complements (C3, C4) levels in infants and young children. Animal experiment with albino rats showed its highest anti-inflammatory activity 3 hours after induction of edema. In-vivo experiment demonstrated that Rathakalka reduced yeast induced elevation of the body temperature in rats. In-vitro experiment revealed that the recipe has anti-bacterial effect on *Staphylococcus aureus*, *Pseudomonas aeruginosa*, and *Listeria monocytogenes*. In-vivo experiment showed that the prolong administration does not produce any toxicity changes in rabbits. Microbiological study indicated that the microbial colony counts observed in this study were within the limits acceptable by the World Health Assembly (W.H.A.). These results scientifically evaluate that the drug samples are tested and deemed microbiologically safe and up to the microbial quality standards. These studies confirmed the presence of immune enhancing effect, anti-bacterial effect, anti-pyretic effect, anti-inflammatory effect, non toxicity, and microbiological safety in Rathakalka. **Acknowledgements:** Thanks to the support and advice given by Prof. S. Widanapathirana, Prof. R.D. Sharma, Prof. Premawathi Tevari, Prof. Manjari Dwivedi, Dr. Usha Singh, Dr. N.C.Arya, Dr. B.M.

Nageeb and all other co-researchers, and the financial grant from Link Natural Pharmaceuticals, and National Science Foundation, Sri Lanka, to carry out this research study.

S-10

Antidepressant New Herbal Product Development

Wang EZ, Jiang Y¹

¹ Suzhou Yi-hua Biomedical Technology Co. Ltd, PRC

Depression related disorders are among the most common psychiatric disorders that affect all age groups of the general population. Currently, the preferred treatment is with pharmacological drugs that have antidepressant or anti-anxiety properties. However, these synthetic antidepressants have numerous and often serious adverse effects, including impaired cognition, ataxia, aggression, sexual dysfunction, tolerance dependence and so on. Withdrawal reactions on termination after long-term administration are also a major limiting factor in the use of these agents. Herbal remedies, for example St. John's wort (*Hypericum perforatum*) or Kava has recently gained popularity as an alternative treatment for mild to moderate depression. Excitingly, we have discovered a medicinal plant named ADP, Chinese traditional medicine, used for inflammation and rheumatic conditions. Its extracts showed significantly antidepressant effect, and minor analgesic, tranquilizing actions, simultaneity, without exciting effect. We believe that it could soon become "Chinese St. John's wort". Pharmacodynamics-experiment (positive control is fluoxetine and Venlafaxine) showed the curative dose of ADP for mouse ED50: 4.56 mg/kg (FST), 3.49 mg/kg (TST); rat ED50: 1.85 mg/kg (FST). Acute-toxicity-experiment showed its LD50 values > 500 mg/kg i.g.; Long-term-toxicity-experiment showed through 6month SD-rats test and 9month Beagle-dogs test, under 40 mg/kg/d (amount to clinical mimic-dose 80 times) ADP was safety. The safe index of ADP for mouse is LD50/ED50 = 152-162 (TST) (Fluoxetine's LD50/ED50=62). The in vitro test and the mechanism of action test indicate that ADP obtained through the method for this invention has prominent (re) uptake inhibiting effect on noradrenaline (NA) and/or 5-hydroxytryptamine (5-HT), and when compared with the extract prepared by using the existing reflux method, it has the advantages of increasing the alkaloid content and the biological activity of the extract. Therefore, ADP may serve as the noradrenaline and/or 5-hydroxytryptamine and/or dopamine (re) uptake inhibitor for development into antidepressant drug, anti-anxiety drug, sedative hypnotic, and anti-senile dementia drug. By now, we have executed 2 applications for China invention patents and authorized by Chinese Patent Bureau (ZL03115911.7; ZL200410084791.7). Meanwhile, we have executed 1 PCT application at 2005, and entered into U.S.A, Japan, Canada, Korea, India, Russia and European Union from 2007(WO2006/058487 A1).

S-11

Quality Control and Standardisation of Botanicals – From Cultivation of Medicinal Plants up to its Clinical Application

Kamil M¹, Naji MA

¹ Zayed Complex For Herbal Research & Traditional Medicine – WHO Collaborative Centre, DPH & P-Health Authority Abu Dhabi, P.O. Box: 29300, Abu Dhabi, United Arab Emirates

In the recent years with ever growing commercialization in the field of herbal medicines, there has been an instant demand for quality control of the drugs used in this system. In the present paper an attempt has been made for a sequential study of the quality control protocols for the herbal medicinal products from selection of medicinal plants, good agricultural practices, cultivation, good field collection practices, source and period of collection, identification and authentication, storage, chemical standardization, assay, good manufacturing practices, pre clinical studies up to clinical approach, with special reference to maintain standardization at all stages. Besides the above protocols, this study deals with approaches towards establishing the quality and safety – starting from preliminary examination of the botanicals, inadvertent con-

tamination/substitution, morpho-anatomical, pharmacognostic, physico-chemical and analytical parameters emphasizing the limits of foreign organic matter, pesticide residue, radioactive and microbial contaminations [1]. Chemical assay and phytochemical screening of different extracts using modern extractors and recent Chromatographic and spectroscopic techniques have been described. Different stages, i.e. quality control studies of raw botanicals, method of processing, finished herbal products, standardization procedures at all stages from birth of the botanicals up to its clinical application will be discussed. Practical experiences for the identification of non-prescription and prescription synthetic chemical medicines (illegal addition) in quite a large number of recent herbal medicinal products will be described in detail. **Acknowledgements:** Thanks are due to ZCHRTM & HAAD, for providing facilities. **References:** [1] Quality Control Methods for medicinal plant materials, WHO (1998; 2007).

S-12

Effect of Polysaccharides on Enteric Mucosal Immune Response in Rats

Lu AP^{1,2}, Zhang WD¹, Chen SL²

¹ Institute of Basic Theory, China Academy of Traditional Chinese Medicine, Beijing 100700, China

² Institute of Modern Chinese Medicine, The Hong Kong Polytechnic University, Shenzhen 518057, China

The effect of *ginseng* polysaccharide and *Polyporus umbellatus* polysaccharide on T-lymphocytes in enteric mucosal lymphocytes in rats, including healthy rats, those with collagen induced arthritis, and with C26 colon carcinoma were explored. For this study peripheral blood mononuclear cells (PBMC), peyer's patch lymphocyte (PPL), intraepithelial lymphocyte (IEL), and lamina propria lymphocyte (LPL) of SD rats were isolated. These lymphocytes were co-cultured with *ginseng* polysaccharide and *Polyporus umbellatus* polysaccharide in different dosages. The TNF- α and IFN- γ in supernatants were measured with ELISA. *Ginseng* polysaccharide and *Polyporus umbellatus* polysaccharide can regulate the level of TNF- α and IFN- γ in the supernatant of PBMC and PPL; *Polyporus umbellatus* polysaccharide in some dosages can increase the level of TNF- α and IFN- γ in supernatant of IEL; *Ginseng* polysaccharide and *Polyporus umbellatus* polysaccharide can decrease the level of TNF- α and IFN- γ in supernatant of LPL. *Ginseng* polysaccharide and *Polyporus umbellatus* polysaccharide can regulate the function of lymphocytes in the enteric mucosal immune system.

S-13

Eliminating Analytical Ambiguity in the Scientific Study, Development and Quality Control of Natural Health Products and Dietary Supplements

Brown PN¹

¹ Integrative Bioscience Research Cluster, British Columbia Institute of Technology, 3700 Willingdon Avenue, Burnaby, British Columbia, V5G 3H2, Canada

Recent surveys have shown that upwards of 71% of Canadians consume natural health products (NHPs) either on a daily or seasonal basis [1] and 73% of American adults surveyed reported taking some type of non-prescription vitamin, dietary supplement or mineral supplements over the course of a year [2]. The prominence of these products in the health care setting is further buoyed by the current deluge of adverse drug effects in conventional medicines. Yet 48% of Americans surveyed believe supplements are not adequately tested [3] and 46% of Canadians agree that a lot of claims made by NHP manufacturers are unproven [1]. In 2002, the World Health Organization attributed problems related to Traditional Medicines, including poor quality research, to a paucity of sound methodology and short-supply of resources [4]. A fundamental scientific flaw of much of the clinical research on botanical-based products has been the failure to characterize the study material, an omission that renders resulting data meaningless [5,6]. Adequately validated methods are an essential prerequisite for producing fair, objective evaluations. A shared feature of CGMP for NHPs and Dietary Supplements is establishment and demonstration of confor-

mity to specifications for identity, purity, and content of defined attributes. This system disintegrates if the analytical methods employed to ensure products meet specifications are not fit for their intended purpose, i.e. validated. A validation study is the scientific process for demonstrating that a test is transferable and will reliably deliver the correct or "true" analytical value. The ICH and U.S. Law (Federal Register 60:11 259-11 262) mandate determination of accuracy, precision, specificity, detection limit, quantitation limit, linearity, and range of any test used for determination of conformity to content (assay) specifications. This review will explore the role of validation and show how failure to properly validate test methods impacts both scientific study and product quality in the marketplace. **References:** [1] Ispos Reid for Health Canada. Baseline Natural Health Products Survey Among Consumers Final Reported Submitted to Health Canada March 2005. Available at http://www.hc-sc.gc.ca/dhp-mps/alt_formats/hpfb-dgpsa/pdf/pubs/eng_cons_survey-eng.pdf. Accessed August 30th, 2006. [2] Timbo BB, Ross MP, McCarthy PV, Lin CTJ. (2006) J Am Diet Assoc, 106(12): 1966-1974. [3] Blendon RJ, DesRoches CM, Benson JM, Brodie M, Altman DE. (2001) Arch Intern Med, 161(6): 805-810. [4] World Health Organization. Traditional Medicine Strategy (2002-2005). Available at <http://www.who.int/medicines/publications/traditionalpolicy/en/>. Accessed August 30th, 2006. [5] Gagnier JJ, Boon H, Rochon P, Moher D, Barnes J, Bombardier C. (2006) Ann Intern Med, 144(5): 364-367. [6] Wolsko PM, Solondz DK, Phillips RS, Schachter SC, Eisenberg DM. (2005) Am J Med, 118(10): 1087-1093.

S-14

Traditional Knowledge Guided Research to Identify Legitimate Substitutes for Rare and Unavailable Herbs

Venkatasubramanian P¹, Subrahmanya Kumar K¹

¹ Foundation for Revitalisation of Local Health Traditions (FRLHT), 74/2 Jarakabande Kaval, Attur Post, via Yelahanka, Bangalore 560064, India

As per the principles and practice of Ayurveda, herbs with similar pharmacological properties can be used as substitutes whenever the original herb is in short supply. There are at least 30 pairs of herbs and substitutes that are mentioned in classical Ayurveda texts [1]. *Cyperus rotundus* L. (Cyperaceae) is claimed to be a legitimate substitute for *Aconitum heterophyllum* Wall. ex Royle (Ranunculaceae). *A. heterophyllum* is a rare and expensive Himalayan herb while *C. rotundus* is a common, tropical, marshy weed. Going by published literature, the two herbs are taxonomically unrelated and dissimilar in major chemicals. However, our preliminary studies indicate that the chromatographic profiles [2] and pharmacological (anti-diarrhoeal) activity are similar in the two drugs making further exploration worthwhile. Research of this kind is essential to identify new substitutes for unavailable herbs and to throw light on the Ayurvedic strategy adopted for selecting substitute drugs. **Acknowledgements:** Thanks go to Al-Ameen College of Pharmacy for conducting the animal studies. Financial support from the TATA Trusts is gratefully acknowledged. **References:** [1] Sastri, B (Ed.) (2002) Yogaratnakara. Chaukhamba, Sanskrit Sansthan. Varanasi, p. 171. [2] Shankar, D. et al. (2007) Curr Sci, 92(11): 1499-1505.

S-15

Metabolomics for Discovery of Novel Medicinal Compounds

Murch SJ¹

¹ University of British Columbia Okanagan, Kelowna, British Columbia, Canada

Plant tissues have complex chemical profiles consisting of both primary metabolites required for growth and development and secondary metabolites that enable the plant to sense and adapt to changing conditions. The products of plant secondary metabolism are a rich resource for discovery of new medicines but traditional methods of discovery such as bioassay-guided fractionation are expensive and time-consuming while some plant-based treatments rely on synergy between several compounds for full biological effect. Metabolomics is the study of the whole complement of small com-

pounds in a biological sample and recently, this technique has been used to discover novel, medically active phytochemicals in traditional plant-based medicines. The overall objective of the Medicinal Plant Metabonomics research program is to assess the capacity for compound discovery by mass spectrometry and NMR-based metabolomics technologies and to quantitatively compare metabolites specific to individual medicinal plants. An extract of a single leaf of St. John's wort (*Hypericum perforatum* L) has been found to contain more 2,500 unique phytochemicals while extracts of species in the genus *Scutellaria* contain more than 4,200 individual compounds. A simple cup of coffee from a commercial retailer can contain between 8,000–10,000 distinct phytochemicals. Efforts to understand this phytochemical complexity and to develop models for study of chemodiversity form the foundation of future research in compound discovery, medicinal plant development and optimized diets.

S-16

Quality Evaluation and Quality Control of Botanicals and Traditional Chinese Medicine

Luo GA¹, Liang QL, Yang HH, Wang YM

¹ Modern Research Center for Traditional Chinese Medicine, Tsinghua University, Beijing, 100084, P.R. China

This presentation will introduce a systemic strategy and relative technologies for the quality evaluation of Traditional Chinese Medicine (TCM), including the identification and differentiation of botanicals and also the quality standard of TCM products. The emphasis will focus on the quality control of manufacture of TCM products, especially to introduce an application of NIRS online analytical technique and quality-based control system into the extraction procedure of TCM. The system hardware was composed of the extraction equipment, the online sample pre-treatment subsystem, the NIRS subsystem, the online NIRS analysis and intelligent control subsystem, and the automatic control subsystem. A diagram of the system is shown in Fig. 1. The whole system includes cooperative-working hardware and software components. The extraction process of TCM was analyzed using online NIRS, and the results demonstrated that NIRS was feasible to be applied to online monitoring and controlling in the manufacturing of TCM. Based on the online NIRS analysis technology, the real-time monitoring of the effective components or indicative components in the extraction procedure, the analysis of the extraction ratios, the diagnosis of the extraction procedure, and the real-time feedback control based on the quality status were actualized.

S-17

HPTLC for Quality Control of Traditional Chinese Medicines: Identification and Detection of Adulteration

Li Z¹, Reich E²

¹ University of Freiburg, Germany, ² CAMAG Laboratory, Sonnenmattstrasse 11, 4132 Muttenz, Switzerland

For cGMP compliance of dietary supplements and quality control of herbal medicinal products, proper identification of herbal raw material is of great importance. In this respect Traditional Chinese Medicines (TCM) can present challenging tasks because pharmacopoeial drug monographs may include multiple species and often don't provide sufficient analytical methods. High Performance Thin-Layer Chromatography (HPTLC) is a very suitable tool for direct comparison of fingerprints from multiple samples side by side and allows determining similarities and differences of related species. Using "BEIMU" (*Fritillaria* spp.) and "CANGZHU" (*Atractylodes* spp.) as examples, the development and use of validated methods for this purpose is illustrated. The traditional approach of associating the quality of an herbal medicine with the quantity of a marker becomes questionable, if the product contains more than one plant material. CANGZHU XIANGLIAN SAN a TCM for veterinary use contains *Coptis* rhizome, *Aucklandia* root, and *Atractylodes* root but the Chinese Veterinary Pharmacopoeia only relies on identification and quantitation of berberin as principal marker. Berberin is present in *Coptis* only. This creates the possibility for adulterated products, missing either of the other two plants to enter the market. We propose an HPTLC method that allows a more complete monitoring of quality by ensuring the presence of all species in the appropriate quantity.

S-18

Relative and Absolute Structures of Diospongin A, B and C

Jun Yin, Zhihui Liu, Na Han, Bin Xiao

College of TCM, Shenyang Pharmaceutical University, 103 Wenhua Road, Shenyang, 110016, China

While screening 60 extracts for their stimulatory activity on proliferation of osteoblast-like cell line and on inhibition of osteoclastic formation, the water extract of *Dioscorea spongiosa* displayed the strongest stimulation on osteoblastic proliferation and strong inhibition on osteoclastic formation. This water extract was separated using bioassay-guiding fractionation and three new diarylheptanoids were isolated and purified. The structures of three new diarylheptanoids were elucidated by analysis of NMR, IR spectra and high resolution FAB-MS. The relative stereochemistry of diospongin A and B was determined by ROESY spectra and coupling constants in ¹H-NMR spectra and their absolute structures were

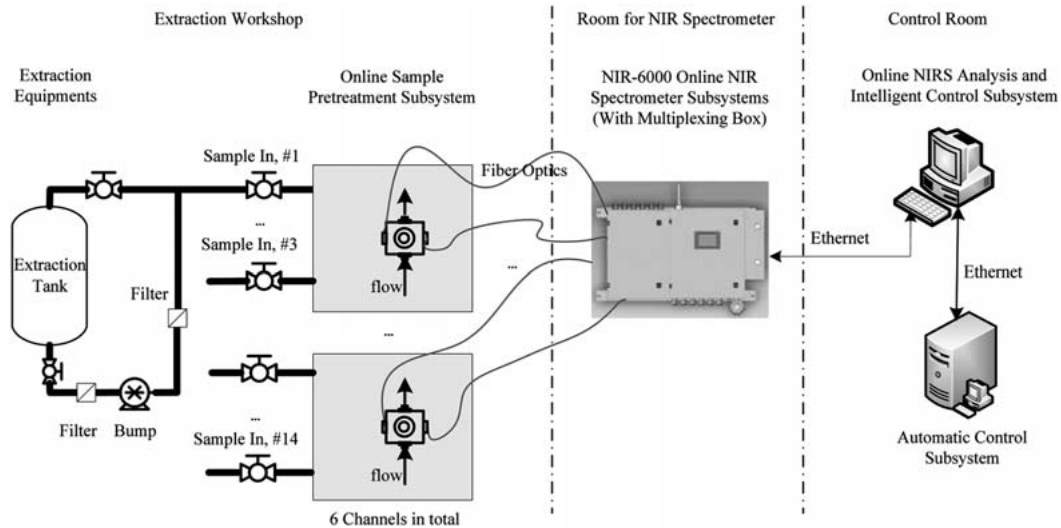

Fig. 1 The system framework of the NIRS analysis and intelligent control system for TCM extraction.

identified by advanced Mosher method. By analyzing the NMR data, diospongin C was found to be an acyclic diarylheptanoid with four hydroxyl groups at C-1, C-3, C-5 and C-7; i.e., 1,7-diphenylheptan-1,3,5,7-tetraol. So there was some difficulty in the decision of its relative and absolute configuration. The relative configuration of diospongin C also can be determined by analysis coupling constants of two protons of C-2, C-4 and C-6 in Newman projections of one corresponding acetone derivative and optimizing dihedral angles [1]. Its absolute stereochemistry was identified by the CD spectrum of its dibenzoate product [2]. All the three compounds were examined the inhibitory activity on osteoclast formation and bone resorption induced by PTH in bone organ culture system. Except for diospongin A, diospongin B and C showed potent inhibition even at a concentration of 20 μ M, which demonstrates that the stereochemistry was important to structure-activity relationship of these diarylheptanoids.

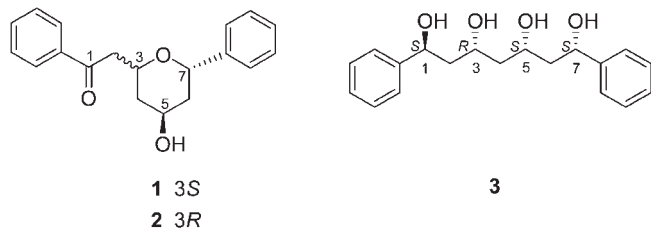

Fig. 1 Structures of diospongin A, B and C.

Acknowledgement: Thanks to Professor Qishi Sun and Yingjie Chen of Shenyang Pharmaceutical University in China for purchasing and identifying the crude drug. Toyama Medical and Pharmaceutical University is also appreciated for the structural measurement of compounds. **References:** [1] Rychnovsky SD, Richardson TI et al (1997). *J Org Chem*, 62: 2925–2934. [2] Wiesler WT, Nakanishi K. (1989). *J Am Chem Soc*, 111: 9205–9213.

S-19

Sourcing of Quality Raw Materials for Indian System of Medicine (ISM) and Botanical Drugs

Bedi YS¹, Dutt HC

¹ *Institute of Integrative Medicine (CSIR), Canal Road, Jammu Tawi-180001, India*

Globally, there has been an unparalleled growth in the plant-derived medicinally useful formulations, drugs and health care products, with annual growth rates between 10–20% in most of the countries. According to WHO, the international market of herbal products is estimated to be US\$ 62 billion which is poised to grow to US\$ 5 trillion by the year 2050. This has attracted many large pharmaceutical and consumer product companies worldwide to have herbals/botanicals in their product portfolio. India is no exception to it and has a competitive edge as Indian Traditional drugs/products, have their roots in time tested systems of medicine namely, Ayurveda, Unani and Siddha. Renewed interest in botanical products has resulted into a huge international trade in raw plant material, feeding a range of such industries, including the \$20 billion botanical medicine market. Presently between 75 and 85% of the raw materials for the botanical industry are sourced from wild. Due to the increasing public demand for quality botanical products, some companies are now making efforts to acquire at least a portion of their raw material from sustainable and ethical sources, but most invest little in this side of their business. The existing industry practice often promotes poor management of species and few benefits for the collectors and cultivators, and many companies remain distant and unaware of the conditions under which raw materials are sourced. However, there also exist opportunities to create change in this sector. The source and quality of raw materials, storage, post-harvest handling play a pivotal role in guaranteeing the quality and stability of ISM & botanical preparations. In India, in addition to the promotion of cultivation of medicinal and aromatic plants (MAPs) by certain government departments and R&D institutes, of late some private herbal drug industries have also started

sourcing their requirement of herbal raw material from cultivated sources. The cultivation of MAPs, on the other hand, would not only lead to better control over quality of the end products but will also reduce anthropogenic stress on wild stands. The presentation will illustrate the efforts being made in India in general and at the Indian Institute of Integrative Medicine (IIIM – CSIR) in particular for the sourcing and sustainable supply of raw materials for ISM & Botanical industry.

S-20

The CIHR Team in Aboriginal Antidiabetic Medicines: A Community-Based Collaborative Approach Uniting Healers and Biomedical Scientists to Validate Cree Traditional Medicine

Haddad PS¹

¹ *CIHR Team in Aboriginal Anti-diabetic Medicines, Department of Pharmacology, University of Montreal, Montreal, Quebec, Canada*

Obesity and Type 2 diabetes are considered as global epidemics by the WHO. Aboriginal populations such as the Cree of Eeyou Istchee (James Bay area of northern Quebec) are particularly affected and suffer greater complications, in part because of the cultural inadequacy of modern pharmaceutical therapies. A multidisciplinary team was therefore put together to explore the antidiabetic potential of Boreal forest plants stemming from Cree Traditional Medicine (TM). The team is composed equally of scientists with expertise in botany, phytochemistry, nutrition, pharmacology, biochemistry, toxicology and clinical endocrinology as well as Cree Elders and members of various Cree health-related institutions, notably including the Cree Board of Health and Social Services of James Bay (CBHSSJB). A novel ethnobotanical approach based on diabetes symptoms was used to identify potential antidiabetic plants. A total of 17 species were characterized phytochemically and screened for primary and secondary antidiabetic activity, toxicological potential and mode of action using a comprehensive platform of bioassays. Most promising species were subjected to bioassay-guided fractionation to identify active principles. Bioavailability as well as anti-hyperglycemic and anti-obesity efficacy are then confirmed using in vivo animal models of obesity, insulin resistance or diabetes. Clinical studies are also underway to document the safety and efficacy of selected species using a culturally-adapted, all-inclusive, observational protocol. Finally, our project represents a pilot study for the integration of Cree TM into diabetes care for the CBHSSJB. Funded by the Canadian Institutes of Health Research.

S-21

Understanding Botanical Dietary Supplements: The Research Need for Well-Characterized Test Materials – Research Grade Botanicals

Miller JS¹

¹ *Dean and Vice President for Science, The New York Botanical Garden*

Interpreting research on botanical dietary supplements, and also replicating research from other labs to confirm results, is complicated by the dietary supplements themselves, which are complex chemical mixtures with composition that may vary dependent on the source of the raw materials, processing and formulation, and stability of the final product. All pharmacological research requires that the substances being tested be characterized sufficiently so that studies can be interpreted as well as replicated and confirmed by other research groups. The chemical composition of botanical dietary supplements is influenced by a wide variety of factors including identity of the source plant material, geographical origin and environmental factors, methods of harvest and processing, formulation, and age of the processed materials. The influence of these factors is reviewed, recommendations are provided for controlling the effect of each variable, and a means of presenting these research results is presented.

S-22

Screening the Efficacy of an Ayurvedic Botanical Formula: "Shothahara Compound" through Scientific and Philosophical Approaches

Kumari MWSJ¹, Ravishankar B², Dewedi RB²

¹ Institute of Indigenous Medicine, University of Colombo, Rajagiriya, Sri Lanka

² Institute of Post Graduate Teaching and Research in Ayurveda, Gujarat Ayurveda University, Jamnagar, India

Ayurveda is an essentially authentic practical science and all the fundamental principles ascertain in it have initiated from a philosophical background and passing through the science to accomplish its ultimate goal. The main objective of this research was to test the efficacy of an Ayurvedic botanical formula "Shothahara Compound" via scientific and philosophical approaches considering the Ayurvedic pharmacodynamics. The formula containing six botanicals, *Cedrus deodara*, *Resimus communius*, *Tinospora cordifolia*, *Terminalia chebula*, *Boerhavia diffusa* and *Zingiber officinale* was selected in the form of dried water-soluble extract. The study was specially planned to evaluate Ayurveda principles in the light of scientific testing by the animal and clinical experiments. The assessment of Dipana Pachana activity, Muthrala activity, Amahara effect, Rasayana effect and Shothahara effect were evaluated by using a food consumption test, effect on fecal output, effect of food conversion ratio, body weight changes, diuretic activity, effect on serum total cholesterol and high-density cholesterol, adoptogenic activity, carrageenan induced hind paw edema in rats and capillary permeability in mice. Charles foster strain albino rats and mice in either sex, bred in animal house of Institute of Post Graduate Teaching and Research in Ayurveda – India, were used for animal trials. Patients suffering from different types of oedema were subjected for clinical study. The data generated from the studies clearly indicated that the subjective Ayurveda basic principles can be tested more efficiently and interpreted logically using modern scientific parameters and results can be expressed objectively to open discussions in the scientific forums for the advancement of science.

S-24

Application of Proteomics in Traditional Chinese Medicine Research

Guo DA¹, Liu X, Yue QX, Ma C, Guan SH, Yang M, Jiang BH

¹ Shanghai Research Center for TCM Modernization, Shanghai Institute of Materia Medica, Chinese Academy of Sciences, Shanghai 201203, P.R. China

Proteomic method (two-dimensional electrophoresis and MS/MS) was used in studying the mechanisms of Traditional Chinese Medicines (TCMs) including *Ganoderma lucidum*, *Salvia miltiorrhiza*, *Panax notoginseng* and toad venom. For example, the effects of *Salvia miltiorrhiza*, a TCM popularly used for treating cardiovascular diseases, on the protein expression profiles of platelets, cardiomyocytes and heart tissues were checked. The results indicated that salvianolic acids from *Salvia miltiorrhiza* could inhibit the aggregation and adhesion of platelets, migration of cardiomyocytes and could protect cardiomyocytes from ischemia-reperfusion injury both *in vitro* and *in vivo*. The effects of salvianolic acids might be based on regulation of expression of proteins related to calcium ion binding, cell skeleton structure, elimination of reactive oxygen species, response to stress, etc. Furthermore, combined effects of salvianolic acids and notoginsenosides, a TCM formula were also studied. The proteomic results showed that, in adjusting the un-normal protein expression profiles caused by ischemia-reperfusion injury back to normal, Fufang had better effect than either salvianolic acids or notoginsenosides. Our results indicated the usefulness of proteomic technology in TCM research.

S-25

Therapeutic Products from Botanical Sources: The Indian Scenario

Taneja SC¹

¹ Indian Institute of Integrative medicine (CSIR), Canal Road, Jammu Tawi, India

The drug and pharmaceutical industry is one of the most rapidly growing and R&D intensive industries in the world. The search for new therapeutic agents and drugs from natural sources, such as plants, received a boost in the recent past due to increased awareness of side effects and toxicity associated with the allopathic drugs, coupled with the belief that botanicals products are green and more acceptable to humans. India, being the fertile ground of several medicinal systems, has given birth to a multitude of medicinal practices, some of them have survived with intact traditional knowledge. The rich Indian heritage associated with prevailing healing practices led to the identification of several medicinal plants and formulations that were traditionally used for curative purpose. Botanicals, as a source of small molecules with a view to identify new therapeutic agents, remains as one of the major developmental as well as academic activities pursued by several institutes and universities in the post independent era in India. However, the resurgence of natural products in the last decade has also forced the participation of private industry in this race. Though Indian contribution in the area of therapeutics agents, may it be a single molecule or standardized botanical preparations, have been far and few. Yet some of the leads generated have been noticed globally and developed into useful products. The present review will cover some of the past and recent efforts made by various agencies in the development of new leads or therapeutics in the Indian context. It will also include the research and development work being carried out at the Indian Institute of Integrative Medicine at Jammu.

S-26

Testing Potential DNA Barcoding Regions in the Labiatae Medicinal Plants

Han J¹, Shi LC¹, Yao H¹, Song JY¹, Xu HX², Sun C¹, Xie CX¹, Chen SL^{1,3}

¹ Institute of Medicinal Plant Development, Peking Union Medical College & Chinese Academy of Medical Sciences, Beijing, 100193, P.R. China

² Chinese Medicine Laboratory, Hong Kong Jockey Club Institute of Chinese Medicine, Hong Kong, P.R. China

³ Hubei University of Chinese Medicine, Wuhan, Hubei, 430065, P.R. China

DNA barcoding has been proposed as a novel and powerful taxonomic tool [1,2]. The universal primer COI has been widely applied in animals, but there is no such universal barcode for plants [3]. In this study, we examined the possibility of utilizing DNA barcode markers to identify labiatae medicinal herbs. First, we compared sequences of eight potential barcodes (AccD, rpoB, rpoC1, ycf5, rbcL, PsbA-trnH, ITS, and matk) among different species of labiatae. Our findings were as follows: (1) PsbA-trnH was amplified much easier than the other seven; (2) PsbA-trnH spacer is one of the most variable non-coding regions of the plastid genome in labiatae; and (3) Different species of labiatae can be differentiated effectively by comparing the PsbA-trnH intergenic region. Comparison of PsbA-trnH intergenic region among 71 species of 30 genus has provided solid and practical evidence for applying DNA barcoding on species identification. In summary, DNA barcoding was proven to be useful in identifying different species of labiatae medicinal herbs. **Acknowledgements:** Thanks go to the International Cooperation Program of Science and Technology (No. 2007DFA30990) and the Special Founding for Healthy Field (No. 200802043), for supporting the study. **References:** [1] Schindel DE, Miller SE (2005) Nature, 435: 17. [2] Miller SE (2007) PNAS, 104: 4775–4776. [3] lahay R, et al. (2008) PNAS, 105: 2923–2928.

S-27

Implementation of Sustainability Standards that Contribute to Assurance of Pharmacopoeial Quality of Wild Collected Medicinal Plants

Brinckmann JA¹

¹ Traditional Medicinals, Research and Development Department, 4515 Ross Road, Sebastopol, California, USA

The majority of commercially traded medicinal and aromatic plant species are wild collected as opposed to being produced through controlled cultivation. In order to assure a consistent supply of uniform botanical raw materials of defined pharmacopoeial quality, long-term relationships, planning, technical cooperation and transparency are necessary throughout the supply chain between the wild collection firms, the intermediate buyers and processors, and the end-user finished product manufacturers. *Liquiritiae radix* PhEur (dried unpeeled or peeled root and stolons of *Glycyrrhiza glabra* L. and/or of *Glycyrrhiza inflata* Bat. and/or *Glycyrrhiza uralensis* Fisch., containing not less than 4.0 per cent of glycyrrhizic acid) [1] is among the most widely used and traded wild-collected medicinal plants in the global market. In 2006, in collaboration with our supplier, we began test implementations of three sustainability standards at our licorice root wild collection site; a) United States Department of Agriculture (USDA) Wild-crop Harvesting Practice Standard [2]; b) International Standard for Sustainable Wild Collection of Medicinal and Aromatic Plants (ISSC-MAP) [3]; and c) FairWild Standard [4]. Our experience to date provides evidence as to how the implementation of these three standards, with independent auditing and reporting, contributes to assuring conformance to the qualitative and quantitative pharmacopoeial standards for composition, identity, quality, purity, and strength, and also facilitate compliance with the production and process control system requirements of Current Good Manufacturing Practice (CGMP) [5]. **References:** [1] European Pharmacopoeial Commission (2008) European Pharmacopoeia, 6th edition. European Directorate for the Quality of Medicines and Healthcare. Strasbourg, France. [2] United States Department of Agriculture (2008) Wild-crop harvesting practice standard. In: *Code of Federal Regulations*, Title 7, Vol. 3, Sec. 205.207, p.395. [3] Medicinal Plant Specialist Group (2007) *International Standard for Sustainable Wild Collection of Medicinal and Aromatic Plants (ISSC-MAP)*, Version 1.0. Bundesamt für Naturschutz (BfN), MSPG/SSC/IUCN, WWF Germany, and TRAFFIC, Bonn, Gland, Frankfurt, and Cambridge (BfN-Skripten 195). [4] Meinshausen F, Winkler S, Bächli R, Staubli F (2006) *FairWild Standards*, Version 1 (11/2006). FairWild Foundation. Weinfelden, Switzerland. [5] United States Food and Drug Administration (2008) Current Good Manufacturing Practice in Manufacturing, Packaging, Labeling, or Holding Operations for Dietary Supplements. Subpart E: Requirement to Establish a Production and Process Control System. In: *Code of Federal Regulations*, Title 21, Vol. 2, Sec. 111.75, p.238–240.

S-28

What Will Happen When ...?

But PPH^{1,3,4}, Shaw PC^{2,3}, Ling KH¹, Chan PWH¹

¹ Food and Drug Authentication Laboratory, Department of Biology,

² Department of Biochemistry, and

³ Institute of Chinese Medicine, The Chinese University of Hong Kong, Shatin, N.T., Hong Kong, P.R. China

⁴ Yunnan Institute of Materia Medica, Yunnan, P.R. China

What will happen? When everyone is excited with the tempo of modernization and globalization of an indigenous medical system, when new findings and inventions are making the headlines, when business in herbal trade is booming, and when patients are converted to believe in the salvation power of herbalism... but botanicals are not properly grown, handled, processed, manufactured and traded? When plant and animal populations in the wild are dwindling down due to over-exploitation, when endangered species are illegally poached for herbal preparations, when botanicals are substituted by threatened taxa, what will happen? When farming of medicinal plants is fragmentary making it difficult to ensure qual-

ity consistence, when mercury is fumed into a botanical to increase its weight for a higher price, when flour is mixed into an herb to make it twice as large for a better sale, when processing and manufacturing procedures are reduced to save expenses regardless of toxin concentrations, what will happen? When prices of botanicals are fixed and investments of talents and financial inputs cannot be recovered, when regulatory agencies can be bribed, when advertisements merge with con artist, what will happen? The answer, my friend, is glowing in the science, the economics and the politics.

S-29

From the Bench to the Bedside: How Natural Products Can Find Their Way

Efferth T¹

¹ German Cancer Research Center, Pharmaceutical Biology (C015), Im Neuenheimer Feld 280, 69120 Heidelberg, Germany, e-mail: t.efferth@dkfz.de

Secondary metabolites from plants serve as defense against herbivores, microbes, viruses, or competing plants. Many medicinal plants have pharmacological activities and may, thus, be a source for novel treatment strategies. We have systematically analyzed medicinal plants used in traditional Chinese medicine during the past decade and focused our interest on *Artemisia annua* L. (qin hao, sweet wormwood). We found that the active principle of *Artemisia annua* L., artemisinin, exerts not only anti-malarial activity but also profound cytotoxicity against tumor cells. The inhibitory activity of artemisinin and its derivatives towards cancer cells is in the nano- to micromolar range. Candidate genes that may contribute to the sensitivity and resistance of tumor cells to artemisinins were identified by pharmacogenomic and molecular pharmacological approaches. Target validation was performed using cell lines transfected with candidate genes or corresponding knockout cells. These genes are from classes with different biological functions; for example, regulation of proliferation (BUB3, cyclins, CDC25A), angiogenesis (vascular endothelial growth factor and its receptor, matrix metalloproteinase-9, angiostatin, thrombospondin-1) or apoptosis (BCL-2, BAX). Artesunate triggers apoptosis both by p53-dependent and -independent pathways. Anti-oxidant stress genes (thioredoxin, catalase, f \times -glutamyl-cysteine synthetase, glutathione S-transferases) as well as the epidermal growth factor receptor confer resistance to artesunate. Cell lines over-expressing genes that confer resistance to established anti-tumor drugs (MDR1, MRP1, BCRP, dihydrofolate reductase, ribonucleotide reductase) were not cross-resistant to artesunate, indicating that artesunate is not involved in multidrug resistance. The anticancer activity of artesunate has also been shown in human xenograft tumors in mice. First encouraging experiences were obtained in the clinical treatment of patients suffering from uveal melanoma. A phase I with artesunate in metastasized breast cancer has been launched in 2008. **References:** [1] Efferth T, et al. (2001) *Int J Oncol* 18: 767–773. [2] Efferth T, et al. (2002) *J Mol Med* 80: 233–242. [3] Efferth T, et al. (2002) *Biochem Pharmacol* 64: 617–623. [4] Efferth T, et al. (2003) *Int J Oncol* 23: 1231–1235. [5] Efferth T, et al. (2003) *Mol Pharmacol* 64: 382–394. [6] Efferth T, et al. (2004) *Free Rad Biol Med* 37: 998–1009. [7] Efferth T, et al. (2004) *Biochem Pharmacol* 67: 1689–1799. [8] Dell'Eva R, et al. (2004) *Biochem Pharmacol* 68: 2359–2366. [9] Efferth T, (2005) *Drug Res Updates* 8: 85–97. [10] Efferth T, (2006) *Curr Drug Targets* 7: 407–421. [11] Efferth T, (2007) *Planta Med* 73: 299–309. [12] Kelter G, et al. (2007) *PLoS One* 2: e798. [13] Efferth T, et al. (2007) *Trends Mol Med* 13: 353–361. [14] Efferth T, et al. (2007) *Curr Med Chem* 14: 2024–2032. [15] Efferth T, et al. (2008) *Mol Cancer Ther* 7: 152–61. [16] Li PCH, et al (2008) *Cancer Res* 68: 4347–51.

S-30

Importance of the Quality of Reference Substances Applied in the Analysis of Herbal Products*Schwarz M¹*¹ *PhytoLab GmbH & Co. KG, Dutendorfer Str. 5-7, 91487 Vestenbergsgreuth, Germany*

Reference substances are used to calibrate and validate the testing methods that are applied within the framework of quality control throughout all of the stages in the production and manufacture of herbal products. The quality of these reference substances is therefore of prime importance to the quality and associated safety and efficacy of these products. Manufacturers of herbal drugs, and dietary supplements in particular, are now also being confronted with a strong increase in the regulations that apply to the reference substances used to analyze their products. While the legal framework and detailed requirements for evidence of quality are clearly regulated for herbal medicinal products these have not yet been defined to the same extent for dietary supplements. However, as health-promoting functions and effects are being claimed to an increasing extent for such products, we must expect the requirements for evidence of their quality to be tightened up as well. This has already taken place in the USA with the introduction of the cGMP for dietary supplements in June 2007. The presentation will focus on the requirements for the analytical characterization of primary reference substances. The necessity to determine not only organic impurities but also water, residual solvents and inorganic impurities will be illustrated by presenting a number of examples of common compounds such as hypericin, hyperforin, hyperoside, silybin and others and by pointing out the crucial points encountered during the establishment, documentation and maintenance of these reference substances. Alternatives, such as quantitative NMR for content assignment of reference substances will be discussed as well.

S-31

Summary on Quality Control of TCMs in Chinese Pharmacopoeia (2010 version)*Qian ZZ¹*¹ *Chinese Pharmacopoeia Commission, Division of Traditional Chinese Medicine, Building 11, Fahua Nanli, Chongwen District, Beijing, 100061, China*

The main aim of the Chinese Pharmacopoeia (ChP 2010 version) is to build up a quality controlling module that is in accordance with the characteristics of TCMs and is different from that of chemical medicines. It will change gradually from using single ingredient to using active, multiple ingredients, fingerprint or bio-determination to totally control the quality of TCMs. For the safety control of TCMs, the species of pesticides were determined examining the pesticide residues according to the actual utility of chemical pesticides. This residue determination is required in more and more monographs within the Chinese material medica. The pesticide residue limits have been established in the ChP (2010 version). Other pollutants, such as heavy metals, sulphur dioxide, etc., were determined, controlled, and their acceptable limits established in the ChP (2010 version). The efficacy control of TCMs, TLC-bioautography and bio-activity determination techniques were used to establish the quality of TCMs. These results may reflect the true quality more directly and precisely than using a single ingredient. For well-controlled quality TCMs, DNA molecular marking and fingerprint techniques were adopted by ChP. DNA molecular marking technique was also used in Chinese material medica monographs to define their species which can not be identified by microscopic, chemical or chromatographic methods, especially in multi-origin CMMs. Fingerprinting techniques were used to control the uniformity and stability of TCMs in order to reflect the integrity of the herbs and their complex ingredients.

S-32

Quality Aspects in the Production of Herbal Extracts*Roth-Ehrang R¹*¹ *Finzelberg GmbH & Co. KG, 56626 Andernach, Germany*

While in Europe products containing herbal extracts as active ingredients are generally handled under the pharmaceutical law and require a marketing authorization, it seems that so-called Botanicals are handled less strictly in the United States and other countries, where Botanicals are marketed as food supplements. In 2007, the U.S. FDA published the current Good Manufacturing Practice (cGMP) for manufacturing dietary supplements in addition to the Dietary Supplement Health and Education Act of 1994 (DSHEA) [1]. Currently, Europe's Food Safety Authority (EFSA) is evaluating for food and for supplements submissions for health claims with the intention to legalize claims for risk reduction and for reduction of disease risk [2]. Furthermore the Council of Europe and the European Federation of Associations of Health Product Manufacturers made proposals for quality guides for plant based food supplements [3,4]. Both the U.S. and E.U. approaches to handle products containing herbal ingredients have proven their suitability but still attitudes to Botanicals are in motion. Taken together, though the approaches on how to deal with food supplements containing herbal ingredients in the United States and in Europe seem to converge, the question about the future position of Botanicals arises. This talk will shed light on different producer related aspects of quality as this debate will consequently also affect GMP for the manufacturer of herbal extracts. **References:** [1] U.S. Food and Drug Administration: Fact Sheet on FDA's Strategy for Dietary Supplements. [2] Regulation (EC) No 1924/2006 on nutrition and health claims made on food. [3] Council of Europe: Guideline on the Quality, Safety and Marketing of Plant-Based Food Supplements, 24.06.2005. [4] European Federation of Associations of Health Product Manufacturers: Quality guide for food supplements, Nov. 2007.

S-33

Stevia: Building the Science and Safety from Botanical to Mainstream Natural Sweetener*Boileau AC¹, Curry LC¹, Carakostas MC², Roberts A³*¹ *Cargill Incorporated, 15407 McGinty Road West, Wayzata, MN 55391, USA*² *MC Scientific Consulting LLC, St. Helena Island, SC 29920, USA*³ *CANTOX Health Sciences International, Mississauga, Ontario L5N2X7, Canada*

Stevia is a generic term for extracts from the herb *Stevia rebaudiana* (Bertoni), while the sweet components are more precisely known as steviol glycosides. Long-standing questions about the specifications or characterization of the materials, safety, and special population effects have previously prevented steviol glycosides from being considered a mainstream natural sweetener. In order to provide the answers as well as bridge to the safety gaps, a strategic step-wise, research program was undertaken. Essential elements of the program included: complete characterization of the ingredient, general and reproductive toxicology, metabolism and pharmacokinetic analysis, clinical research, intake/exposure assessment, assurance of appropriate GMP to support specifications, and stability in food systems. A holistic approach to the communication of technical and scientific supporting data was used to ensure general recognition of safety by qualified individuals (GRAS). Efforts are ongoing to promote consistent quality standards within the industry, and to provide due diligence with respect to safety from the post-marketing perspective.

S-34

Organic and Inorganic Arsenic in Natural Health Products

Kyeyune V¹, Alladin T¹, Lessard S¹, Hussien H¹, Marles R¹

¹ The Natural Health Products Directorate, Health Products and Food Branch, Health Canada, 2936 Baseline Road, Ottawa, Ontario, Canada K1A 0K9

Arsenic is present in the environment in both organic and inorganic forms. While organic arsenicals are generally considered to have very low toxicity, the inorganic species is widely recognized as a carcinogen in addition to causing numerous other adverse health effects following acute or chronic exposure [1, 2]. The tolerance limit for arsenic as a contaminant in natural health products (NHPs) currently recommended by Health Canada's Natural Health Products Directorate (NHPD) is 0.14 µg/kg body weight/day [3]. However, this limit represents total arsenic and does not distinguish between organic and inorganic arsenical compounds. Consequently, this current limit may be unnecessarily restrictive for the NHP industry as certain products may contain high levels of relatively non-toxic organic arsenic forms, but only minimal amounts of the toxic inorganic arsenic. NHPD investigated this issue in order to determine whether there is substantial scientific evidence to support separate limits for inorganic and organic derivatives of arsenic, and whether suitable analytical methodology exists to distinguish between these forms in finished NHPs. The review involved assessing arsenic toxicity, analytical methodology, and exposure scenarios for natural ingredients used in dietary supplements (e.g. kelp). NHPD recommends maintaining the current tolerance limit of 0.14 µg/kg bw/day for total arsenic in NHPs at the finished product stage. However, if total arsenic content in a particular NHP exceeds the current tolerance limit of 0.14 µg/kg bw/day (taking into account dosage and subpopulation), the applicant may undertake additional arsenic speciation testing to demonstrate that inorganic arsenic consumed by ingesting the product would be <0.03 µg/kg bw/day and that organic arsenic consumed by ingesting the product would be <20 µg/kg bw/day. **Acknowledgements:** This research project benefitted from scientific expertise within Health Canada Offices and Directorates, the United States Pharmacopoeia, and NSF International. **References:** [1] Environment Canada. 1999. Canadian Environmental Protection Act, List of Toxic Substances, Schedule 1, Item 28. URL: <http://canadagazette.gc.ca/partII/2000/20000329/html/sor109-e.html> accessed 2008-12-09. [2] ATSDR: Agency for Toxic Substances and Disease Registry. 2007. Toxicological Profile for Arsenic. US Department of Health and Human Services. URL: <http://www.atsdr.cdc.gov/toxprofiles/tp2.html>, accessed 2008-01-02. [3] Health Canada. 2007. Evidence for Quality of Finished Natural Health Products (Version 2). Natural Health Products Directorate. URL: http://www.hc-sc.gc.ca/dhp-mps/prodnatur/legislation/docs/eq-paq_e.html, accessed 2008-12-09.

S-35

The Impact of Global Supply and Trade on Botanical Ingredients and Industry Practices

Israelsen LD¹

¹ United Natural Products Alliance, 1075 Hollywood Avenue, Salt Lake City, Utah 84105, U.S.A.

More than ever, the global botanical industry faces unprecedented challenges with respect to quality standards, intentional adulteration, analytical method development, as well as an array of regulatory issues. Understanding global supply, global trade and consumer demand for botanicals is essential if quality, safety and efficacy are to be respected. This presentation will provide an international perspective of leading issues and their implications for botanical traditional medicines and dietary supplements.

S-36

The Anatomy of Spontaneously Reported Dietary Supplement Adverse Events and a Standardized Process to Score and Interpret Collected Events

Kingston RL^{1,2}, LeMaster S^{1,2}

¹ SafetyCall International Poison Center, 8009 34th Ave S. Ste. 875, Bloomington MN 55425

² University of Minnesota, College of Pharmacy, Minneapolis MN 55455

Enforcement of the 2006 Dietary Supplement and Nonprescription Drug Consumer Protection Act (DSNDCPA) began in December 2007. FDA published guidance documents regarding compliance and reporting of "serious" events but there has been no guidance on how "serious" and "non-serious" reported events are being evaluated by FDA or others so as to insure that products are meeting expectations of safety, warranting consumer confidence. Experience to date demonstrates a high variability in quality and integrity of reported incidents and there is no recognized method regarding scoring of events by experts so as to assess potential associations between alleged adverse events and product use. Without such a scoring and evaluation system, collected data represents unconfirmed allegations of product use and injury, rendering benchmarking between and across product lines an exercise in futility. The SafetyCall International Poison Center, an academically affiliated, multidisciplinary, triple licensed medical practice composed of clinicians with specific expertise in clinical medicine and toxicology, natural product pharmacology and consumer product safety has designed a system to score spontaneously reported adverse incidents involving botanicals containing dietary supplements. Using six common parameters to gauge association including expectedness, temporality, biologic plausibility, de-challenge, re-challenge, and consideration of confounding variables, a standardized scoring system has been developed. The system was successfully piloted with a proprietary blend dietary supplement and provides a means for manufacturers to benchmark their product safety experience. Description and application of the scoring system will be presented along with representative scoring of actual adverse events represented in the new FDA adverse event database.

S-37

Recent Developments in Regulatory Matters on Herbal Medicinal Products in Europe

Vlietinck AJ¹

¹ Laboratory of Pharmacognosy and Pharmaceutical Analysis, University of Antwerp, Universiteitsplein 1, 2610 Antwerp, Belgium

Within the group of industrially prepared herbal or botanical products there is a large variation worldwide with regard to the properties and the legal status of these products. Some herbal products are close to or are medicines, while others are close to or even identical to foods such as dietary supplements, functional foods, novel foods, etc. and still others are considered as cosmetics or medical devices. Therefore it is not surprising that recently appropriate regulatory actions have been undertaken to regulate and harmonize the legal status of these various groups of plant preparations throughout Western countries. The European Union (EU) has recently considered herbal products in several legislative texts. Medicinal use has been harmonized for herbal medicinal products (HMP) with regard to well-established (WE) and traditional (T) uses through Directives 2004/27/EC and 2004/24/EC amending Directive 2001/83/EC. Use of herbal preparations in unit dose form under food law is covered in the Food Supplements Directive (FSD) 2002/46/EC. Regulations on nutrition and health claims and the addition of vitamins and minerals and certain other substances to foods have been adopted on December 12, 2006. (Council Regulations (EC) n°1924/2006 and 1925/2006). Nevertheless, the distinction between traditional herbal medicinal products and food supplements containing herbal products without nutritional value but having physiological effects remains vague and controversial. In this presentation the implementation of the current European regulations at the level of the EU Member State authorities and

manufacturers in terms of quality, safety and efficacy of these herbal products will be discussed. A comparison will be made with other concepts existing worldwide, taking into account not only the above mentioned properties, but also aspects such as access to the market, cost price, and prospects for innovation of herbal products.

S-38

FDA's Dietary Supplement Good Manufacturing Practice Regulatory Requirements for Globally Marketed Botanicals

Frankos VH¹

¹ Division of Dietary Supplement Programs, U.S. FDA

The Dietary Supplement (DS) CGMPs should help prevent inclusion of the wrong ingredients, too much or too little of a dietary ingredient, contamination (e.g. natural toxins, bacteria, pesticides, glass, and heavy metals such as lead), and improper packaging and labeling. Following DS CGMPs will increase consumers' confidence in the quality of the dietary supplement products that they purchase. The CGMPs apply to all domestic and foreign companies that manufacture, package, label or hold dietary supplements, including those involved with the activities of testing, quality control, packaging and labeling, and distributing them in the U.S. The final DS CGMP rule does not apply to raw ingredient manufacturers, although they will continue to need to meet the food CGMP regulations. This presentation will provide an overview of the key CGMP requirements that foreign suppliers of botanical ingredients and dietary supplements should be aware of.

S-39

Adverse Event Reports Submitted to U.S. Food & Drug Administration Associated with Dietary Supplements

McGuffin M¹

¹ American Herbal Products Association, 8630 Fenton St., #918, Silver Spring, MD 20910

The Federal Food, Drug, and Cosmetic Act was amended in 2006 to require marketers of dietary supplements and nonprescription drugs to submit to the U.S. Food & Drug Administration (FDA), as of December 22, 2007, all reports of serious adverse events associated with and received by marketers of products in these regulatory categories. The new law established additional responsibilities with regard to follow-up reports and recordkeeping. Adverse event reports submitted to FDA during 2008 by marketers of dietary supplements were obtained from FDA through requests under the Freedom of Information Act. Analysis of these records shows that most reports are submitted by marketers, though reports are also submitted by individual consumers and health care practitioners. There are more reports associated with women than with men, and with individuals between the ages of 50 and 79 than with older or younger consumers. FDA's issuance on March 27, 2008 of a warning to advise consumers to refrain from purchasing products sold as Total Body Formula followed the agency's receipt of 25 adverse event reports associated with the products, indicating that the reporting system is functioning as a signal generator that assists FDA in acting promptly to protect the public health.

S-40

Improving the Odds of Developing New Drugs from Botanicals: Botanical Review Team's Perspectives

Dou J¹, Chen S¹

¹ Botanical Review Team, Office of Drug Evaluation I (HFD-101), CDER, Food and Drug Administration, Silver Spring, MD

There is no doubt that plants and animals have provided mankind with numerous purified small molecule drugs and there is reason to hope that botanical mixtures will have more to give us. Botanical mixtures, are widely used as dietary supplements in the United States or as herbal medicines elsewhere, have, for the most part, not been extensively studied through well-controlled clinical trials to show beneficial effects. We hope this will change and that more botanical derived pure compounds as well as botanical mix-

tures will be developed as drugs. The publication of FDA's "Guidance for Industry-Botanical Drug Products" (drafted in 2000 and finalized in 2004) paved the regulatory pathway for developing botanical mixtures as new drugs. The first botanical drug (Veregen[®], derived from green tea) approval through investigational new drug (IND) and new drug application (NDA) processes in 2006 shows that well defined botanical mixtures can be approved as new drugs with demonstration of safety and efficacy through well-controlled clinical trials. Since the publication of the guidance, there has been a growing interest in botanical drug development judged by the increasing numbers of botanical INDs and pre-IND consultations, with a cumulative total of over 350 and growing. Few of the botanical INDs with phase 1 and/or 2 clinical trials have, to date, advanced into late-phase clinical trials. So far, the Veregen[®] NDA remains the only one submitted and subsequently approved. Although the reasons for this are no doubt different in different cases, several common issues related to quality control and trial designs, among others, have been observed by the Botanical Review Team. A discussion of these issues could shed light on the seemingly low percentage of botanical INDs entering late-stage drug development. We would love to see more botanicals being further developed as new drugs with more success.

S-43

Novel Active Constituents of *Momordica Charantia* L.

Zhang Y¹, Cui JM¹, Cao JQ², Pan H³, Zhao YQ²

¹ Yanbian University of Medicine; Yanji 133000, China

² School of Traditional Chinese Materia Medica, Shenyang Pharmaceutical University; Shenyang 110016, China, E-mail: zyzq4885@126.com. Tel.: +86-24-2398522

³ Beijing ChiaTai Green Continent Pharmaceutical Co., Limited; Beijing 100018, China

Momordica charantia L. (Cucurbitaceae) is widely used as a traditional medicine, having antidiabetic, antitumor, antiviral activities and so on. Many triterpenoids and other components had been found from *M. Charantia*. In our present work, the fruit of *Momordica Charantia* L. were extracted by alcohol then purified by D-101 macro porous absorptive resin followed by chloroform extraction. Isolation and purification were carried out by silica gel chromatography resulting in nine compounds: three novel cucurbitane-type triterpenoids, named charantagenins A(1), B(2) and C(3), (+)-eduesmin(4) and blumenol A(5) are being reported for the first time from *Momordica Charantia* L., and four known compounds: karavilagenin D(6), 3 β ,7 β ,25-trihydroxy-cucurbita-5, (23E)-diene-19-al(7), 5 β ,19-epoxycucurbita-6,23 E-diene-3 β ,25-diol(8) and 5 β ,19-epoxycucurbita-6,23-diene-3 β ,19,25-triol(9). The compounds were identified and elucidated by spectral and chemical methods. In addition, they were tested for their cytotoxicity against six cancer cell lines by MTT assay. Test solutions were given to cells in various final concentrations such as 0, 1, 10, 50, 100 μ mol/L. The cytotoxic potential of the isolated compounds was investigated by determining the concentrations required for 50% growth inhibition (IC₅₀ value). Compounds 1 and 7 showed cytotoxicity. Compound 7 exhibited little cytotoxicity towards Du145 prostatic carcinoma cell line (IC₅₀ 61.36 μ mol/L), MCF-7 mammary adenocarcinoma cell line (IC₅₀ 30.56 μ mol/L), HL-60 leukemic cell line (IC₅₀ 23.63 μ mol/L), HGC gastric carcinoma cell line (IC₅₀ 50.96 μ mol/L), Colon205 colon carcinoma cell line (IC₅₀ 34.49 μ mol/L) and HepG2 hepatoma carcinoma cell line (IC₅₀ 41.69 μ mol/L). Compound 1 showed cytotoxicity only towards MCF-7 (IC₅₀ 41.74 μ mol/L). The remaining compounds showed no cytotoxicity.

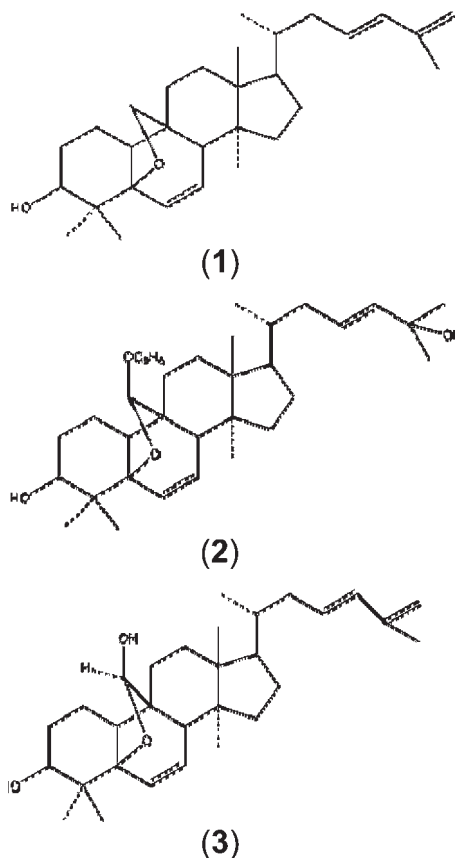

S-44

Analysis and Screening of Bioactive Components in Chinese Herbal Medicines by HPLC and Hyphenated Techniques

Li P, Qi LW, Zhou JL

Key Laboratory of Modern Chinese Medicines, China Pharmaceutical University, Ministry of Education; Nanjing 210009, China

The idea of combination therapy has been practiced in Traditional Chinese Medicine for thousands of years, and has been gaining ever-increasing acceptance in the world. During the past decade, owing to changes in the types of disease and limitations of Western medicine, the usage of Chinese herbal medicines (CHMs) has expanded globally. CHMs are complex mixtures consisting of thousands of compounds. Getting useful chemical and bioactive information from these highly complicated matrices has long been one of the major challenges to chemists, analysts, biologists and pharmacologists. The speaker, Prof. Li, is the head of Key Laboratory of Modern Chinese Medicine, Ministry of Education, and the director of Department of Pharmacognosy at the China Pharmaceutical University and has been working in the field of CHMs for over 20 years. The most often used instrumental technique, high-performance liquid chromatography (HPLC) remains unchallenged for the analysis of CHMs, because of it is low-cost, readily availability and easy of use. This report covers current HPLC-based strategies for the analysis of CHMs, and is divided into three major sections. These are simultaneous qualification and quantification of various components in CHMs (in vitro), metabolite identification and pharmacokinetic investigation of CHMs' components in biological samples (in vivo), and biomacromolecule (protein and DNA) affinity/LC-MS for screening of multiple bioactive candidates in CHMs. **Acknowledgements:** Financial support for this research from the National Science Foundation of China (No.90709020, 30530870) is gratefully acknowledged.

S-45

Anti-tumor Constituents of Four Medicinal Plants from *Lysimachia* Genus

Yang SL^{1,2}, Lihua Tang LH¹, Tian JK², Guo J², Xie C², Xu QM¹, Xu LZ²

¹ School of Pharmacy, Medical College of Soochow University, Suzhou 215123, P.R. China

² Institute of Medicinal Plant Development, Peking Union Medical College & Chinese Academy of Medical Sciences, Beijing 100094, P.R. China

Lysimachia is a large genus of medicinal plants belonging to the PRIMULACEAE family, with about 180 species distributed worldwide. It is a folk medicinal plant used in some syndromes such as hypertension and rheumatic disease. There are limited studies on the chemical constituents and pharmacological activities of plants in this genus. Since 1994, a systematic study on the bioactive constituents of four species (*Lysimachia congestiflora*, *Lysimachia capillipes*, *Lysimachia davuria* and *Lysimachia clethroides*) have been carried out by our group. Till now 86 compounds have been purified and identified on the basis of spectroscopic analysis and chemical methods, with saponins and flavonoids as the major constituents. Among them, 28 new oleanane triterpenoids and 4 new flavonoids were first reported, and two kinds of new saponin aglycones were first revealed as 3 β , 16 α , 22 α -trihydroxy-28 \rightarrow 13-lactone-oleanane and 3 β , 22 α , 28-trihydroxy-15 α , 16 α -epoxy-olean-12-ene. ZTF, a plant extract from *Lysimachia clethroides*, has shown clear antitumor activities against S180, H22, U14 and L1210 cell lines both *in vivo* and *in vitro*. It also induces cell apoptosis in HL-60, SMMC-7721 and K562 cell, inhibited metastasis on hepatoma and uterine cervix cancer. ZTF has potential to be developed as an anti-tumor drug, and its preclinical research is now underway.

S-46

Study on Bioactive Compounds with Molecular Diversity from Toxic Plants in China

Yu SS¹

¹ Key Laboratory of Bioactive Substances and Resources Utilization of Chinese Herbal Medicine, Ministry of Education; IMM, CAMS & PUMC, 100050, Beijing, China

Natural products play a dominant role in the discovery of leads for the development of drugs for the treatment of human diseases. In China, much of nature's sources remain to be explored, particularly the toxic plants, that no doubt host novel, bioactive chemotypes that await discovery. There are more than 900 species of toxic plants in our country. The bioactivities of extracts of over 150 toxic plants were investigated in our group. It was found that more than 20 toxic plants showed vasodilator activities and anti-tumor activities, of which 7 toxic plants were further studied by bioassay-guided technique. From the five toxic plants, more than 250 compounds were isolated, including 9 new skeleton compounds and more than 80 novel compounds, of which more than 50 compounds exhibited significant bioactivities to different targets. It lays a foundation for the study of innovative drugs and the elucidation of bioactive substances from toxic plants.

S-47

Authentication of Fruit Extracts of *Emblica officinalis* Gaertn (Euphorbiaceae): Identification of Valid Biomarkers

Majeed M¹, Bhat B¹, Jadhav AN¹, Srivastava JS¹, Nagabhushanam K¹

¹ Sami Labs Ltd. 19/1 and 19/2, I Main, II Phase, Peenya Industrial Area, Bangalore 560 058, India

The fruit extract of *Emblica officinalis* Gaertn. (Euphorbiaceae), commonly known in India as amla (Indian gooseberry), has been popularized as a dietary supplement in the United States and elsewhere, with its antioxidant benefits being attributed to a high content of ascorbic acid. The presence of ascorbic acid in the extract was questioned by earlier researchers, and hydrolysable tannins, emblicanins A and B were identified [1] and structurally defined [2]. Our investigations on the emblicanins and ascorbic acid con-

tent of the fruit juice and extract, however revealed that ascorbic acid co-elutes with other compounds of similar spectral behavior. Additionally, the hydrolysable tannins, when evaluated were found to be structurally different from the previously reported structures. The earlier reported antioxidant hydrolysable tannins, emblicanin A and B, correspond to beta-glucogallin (1) and mucic acid 1,4-lactone 5-O-gallate (2), respectively. Only trace amounts of free ascorbic acid were detected. β -glucogallin is therefore a more relevant and optimal biomarker in *Emblica officinalis* extract, than ascorbic acid. **References:** [1] Ghosal S, et al. (1996) *Indian J Chem* 35B: 941–948. [2] Pozharitskava ON, et al. (2007) *J Sep Sci* 30: 1250–1254.

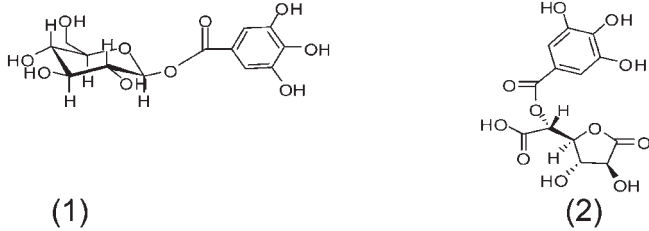

S-48

Integration of Gene-to-Metabolite Networks for Understanding Global Responses of Phenolic Acids Biosynthesis in *Salvia miltiorrhiza*

Xiao Y¹, Yi B¹, Duan YB¹, Chen JF¹, Liu Y¹, Chen WS^{1,3}, Lei Zhang L²

¹ Department of Pharmacy, Changzheng Hospital, Second Military Medical University, Shanghai 200003, P.R. China

² Department of Pharmacognosy, School of Pharmacy, Second Military Medical University, Shanghai 200433, P.R. China

³ Modern Research Center for Traditional Chinese Medicine, Second Military Medical University, Shanghai 200433, P.R. China

Salvia miltiorrhiza Bunge, named “Dan-Shen” in Chinese as a traditional Chinese medicine, is used for improving body function, as well as for cardiac symptoms treatment for hundreds of years in China. The phenolic acids such as rosmarinic acid (RA) and its derivative lithospermic acid B (LAB) aroused scientists’ interest in the last twenty years because of their notable pharmacological activities [1]. In our present study, abiotic elicitors such as methyl jasmonate (MeJA) and Ag⁺ were found to enhance the phenolic acids at various levels. Meantime, based on the profiling changes of several related gene transcripts and metabolites (intermediates) accumulations, in response to elicitors, a gene-to-metabolite network for understanding of global responses to abiotic elicitation in *S. miltiorrhiza* is established (1), and a potential (putative) biosynthesis process from RA to LAB was presumed (2), which prompted the possibility of a key gene-based metabolic engineering for the synthesis of active pharmaceutical compounds in *S. miltiorrhiza*, and would certainly help us to globally and deeply understand metabolic flux of RA synthesis, both at stressed-elicitation and genetic-regulation levels. **Acknowledgements:** This research was financially supported by National Natural Science Foundation of China (20572130, 30600807). **References:** [1] Liu AH, et al. (2006) *J Pharm Biomed Anal*, 41: 48–56.

S-49

Studies on the Chemical Constituents and Biological Activities of Four Medicinal Plants from *Ilex* Genus

Tu PE¹, Zhou SX, Xie GB, Zheng J, Tang L, Lei Y

¹ State Key Laboratory of Natural and Biomimetic Drugs, Peking University, Beijing, 100083, P.R. China

There are about 204 plant species of *Ilex* genus in China, and more than 30 of which are used as traditional Chinese medicine (TCM) or folk medicines to treat various diseases [1]. In order to systematically find out the chemical constituent's and bioactives of *Ilex*

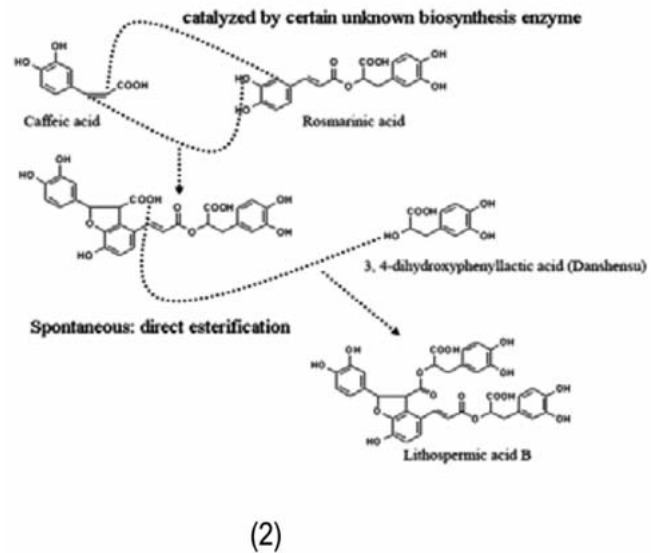
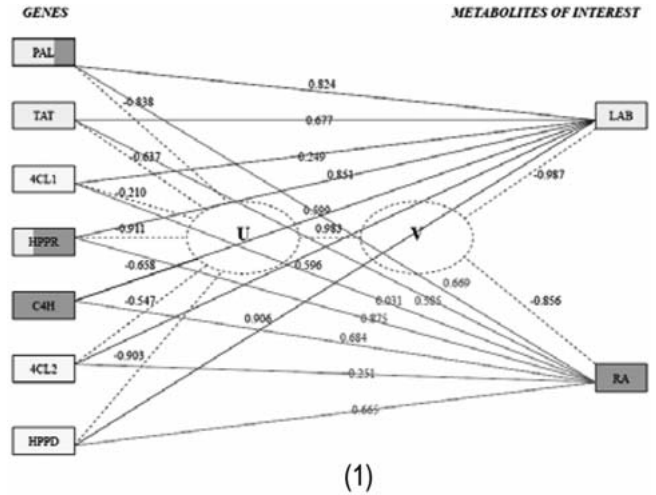

plants, and lay a foundation of discovering leading compounds, we carried out an investigation on several medicinal plants of *Ilex* genus. Herein, we report the research results of 4 medicinal plants of which, including *Ilex kudingcha*, *Ilex hainanensis*, *Ilex pernyi* and *Ilex asprella*. In total, 194 compounds were isolated and identified from the above 4 plant species, 61 of those are new compounds, and 98 of those are triterpenoids or triterpenoid saponins. Also, the biological screening of triterpenoids and triterpenoid saponins that are the primary and typical constituents of *Ilex* genus, were assayed for their affect on the cell's absorption of aggregated low density lipoprotein (aggLDL). A cell based-screening model was applied on aggregated LDL induced-lipid deposition in macrophages to test the inhibitory effects of these compounds. The compounds with inhibitory effects on the intracellular accumulation of aggLDL in macrophages could be regarded as having the potential bioactivity of anti-atherosclerosis. The data indicated that 19 compounds have an inhibition effect on aggLDL absorption. Remarkably, kudinoid A, C and IPB-20 show the significant bioactivity, whose inhibition ratio is 81%, 92%, and 85% at a concentration of 0.2 mg/ml respectively. Thus, the three compounds could be the potential candidate for the treatment of arteriosclerosis. **Acknowledgements:** Thank the National Science Foundation of China for financial support (No. 30672608). This work was also supported by the program for Changjiang Scholar and Innovative Team in University (No. 985-2-063-112). **References:** [1] The editor committee for Flora of China of Chinese Academy of Sciences. (1999) *Flora of China*. Science Press, Beijing, China.

Poster Session

P-1

Effects of Nitrogen on the Yield and Quality of Selected Chinese Medicinal Plants of the Lamiaceae FamilyGardner Z¹, Jun Pill Baek JP, Donia AER, Craker LE¹ Medicinal Plant Program, Department of Plant, Soil, & Insect Sciences, University of Massachusetts, Amherst, MA, 01003

With many of the practicing acupuncturists in the United States prescribing herbal formulas, the demand for Chinese medicinal plants has been increasing. In the past several years, however, quality concerns have been raised about medicinal plants imported from China. To assure the safe and efficacious care for patients, practitioners need good quality plant material produced under controlled and documented conditions in accordance with good agricultural practices. The objective of this research was to determine whether quality plant material of selected species of Chinese medicinal plants could be cultivated in the northeastern United States and whether such cultivation was economically feasible. For these reasons, *Agastache rugosa* (Fisch. & C.A. Mey.) Kuntze, *Leonurus heterophyllus* Sweet, *L. sibiricus* L., and *Schizonepeta tenuifolia* Briq. were field grown in a randomized complete block design using 0, 100, and 200 kg ha⁻¹ of nitrogen supplied as soybean meal. The nitrogen treatments resulted in dose-related increases in yield in all species. Preliminary organoleptic evaluation (color, aroma, taste, cleanliness) suggests the cultivated Chinese medicinal plants were of higher quality than commercially available plant material imported from China.

P-2

The Effect of Propagule Type on Yacon Propagation, Growth and Development in MississippiSumiyanto J^{1,2}, Bolonhezi D^{1,4}, Khan IA^{1,2,3}, Moraes RM^{1,2}¹ National Center for Natural Product Research, Research Institute of Pharmaceutical Science, School of Pharmacy, The University of Mississippi, University, MS, 38677² Center for Water and Wetland Resources, The University of Mississippi Field Station, Abbeville, MS, 38601³ Department of Pharmacognosy, School of Pharmacy, The University of Mississippi, University, MS, 38677⁴ Instituto Agronomico de Campinas, Brazil

Diet-related chronic diseases such as diabetes, high blood pressure, and colon cancer are growing problems in industrialized countries and obesity is the major cause with 36 million deaths annually in the world. Yacon, *Smalanthus sonchifolius*, (Poepp. et Endl.) H. Robinson, is a root crop and is a rich source of phenolic compounds and dietetic oligofructans with low glucose content [2]. These constituents have shown efficacy in the treatment and prevention of diet-related chronic diseases, including gastrointestinal disorders and diabetes. The objective of this study is to develop an integrated system that promotes yacon as a sustainable root crop industry in Mississippi, including root and leaf production, as well as processing yacon into value added commodities as functional food. Yacon is native to Peruvian Andes and originally grows at elevation 1800–2800 of meters above sea level (masl) [1]. The purpose of our work is to evaluate Yacon growth in Mississippi during the hot and dry summers at elevation of 137.8 masl. Yacon propagules were produced by tissue culture and by stem cuttings. Micropropagated plantlets adapted to soil conditions at an average of 90%. A significant difference on plant height, number of roots, leaf and root biomass was noticed for plants cultivated in pots which were produced by tissue culture. Only plants produced from stem cuttings were planted in the field and during the first growing season the average yield reached 0.755 kg of fresh weight per plant. **Acknowledgements:** Thanks go to Mr. Mark Baker, the resident Director of UM Biological Field Station, for preparing the field for yacon plantings and Ms. Michelle Edwards for taking several pictures. This research work was partially supported by the USDA/ARS Cooperative Research Agreement No. 58-6408-2-009. **References:** [1] Grau A,

Rea J, (1997) Yacon, *Smalanthus Sonchifolius*, 21: 224–231 [2] Lachman J, et al. (2003), *Plant Soil Environ*, 49(6): 283–290

P-3

In vitro Monocyte Activity of Echinacea purpurea: Endophytic Bacteria is Affected by the Host's Genetic Diversity and Harvest TimingMoraes RM^{1,2}, Sumiyanto J^{1,2}, Lata H¹, Tamta H¹, Pugh ND¹, Wu XM, Joshi VC¹, Khan IA^{1,2,3}, Pasco DS^{1,3}¹ National Center for Natural Products Research,² Center for Water and Wetland Resources,³ Department of Pharmacognosy, Research Institute of Pharmaceutical Sciences, School of Pharmacy, The University of Mississippi, MS, 38677, USA

Our previous report demonstrated that the majority of *in vitro* monocyte/macrophage activation exhibited by extracts of *Echinacea* and other immune enhancing botanicals depends on bacterial lipopolysaccharides and Braun type bacterial lipoproteins (1). We later showed that the activity of diverse commercial *Echinacea* bulk material varied substantially (up to 200-fold), and that the majority of this activity was also due to these two bacterial components (2). The objective of this study was to determine the contribution of host plant genetics and time of harvest as factors influencing the variation of *E. purpurea* root and leaf activity. The immune enhancing activity of the aerial part was substantially higher when harvested during the onset of leaf/stem senescence and was the only harvest time where genotypic differences were evident. There was less variation in root activity due to harvest time and genotypic diversity. Although these two factors may have contributed to the large variation in immune enhancing activity previously observed in bulk *E. purpurea* material obtained from different suppliers in North America, other environmental and agronomic factors may have a greater influence. **Acknowledgements:** This research was partially funded by grants from the National Institute for Health RO1 AT002360 (NCAAM) and by the USDA, Agricultural Research Service Specific Cooperative Agreement No. 58-6408-7-012. **References:** [1] Pugh ND, et al. (2008) *Int Immunopharmacol* 8: 1023–1032. [2] Tamta H, et al. (2008) *J. Agric. Food Chem.* 56 (22): 10552–10556.

P-4

Assessment of Cannabinoids Content in Micro-propagated Plants of Cannabis sativa L. and their Comparison with Vegetatively Propagated Plants and Mother Plant at Different Stages of GrowthChandra S¹, Lata H¹, Mehmedic Z¹, Khan IA^{1,2}, ElSohly MA^{1,3}¹ National Center for Natural Product Research, Research Institute of Pharmaceutical Sciences, School of Pharmacy, University of Mississippi, MS, 38677, USA² Department of Pharmacognosy, School of Pharmacy, University of Mississippi, MS, 38677, USA³ Department of Pharmaceutics, School of Pharmacy, University of Mississippi, University, MS, 38677, USA

True-to-type clonal fidelity is one of the most important prerequisites for rapid multiplication of plant species. However, there is always a concern of potential differences due to mutation and their effect on the chemical constituents of *in vitro* propagated (IVP) and vegetatively propagated (VP) plants from same source (MP). Clonal fidelity was tested among the three groups of plants (MP-indoor, IVP and VP). After the plants were well established in the soil [1,2] samples from all three groups of plants, were periodically analyzed for their cannabinoids content to determine if differences in secondary metabolites exist within and among these groups of plants. The content of six major cannabinoids: D⁹-THC, THCV, CBD, CBC, CBG and CBN were identified and analyzed using gas chromatography/flame ionization detection (GC/FID). In general, THC content in all groups increased with plant age up to a highest level during budding stage where the THC content reached a plateau before the plants were harvested. The pattern of changes occurred in the concentration of other cannabinoids content relative to the plants age and has followed a similar trend in all groups. Minor differences observed in cannabinoids concentrations within and among the

groups were found statistically insignificant. These results confirm the clonal fidelity of tissue culture raised plants of *Cannabis sativa* and suggest that the biochemical mechanism followed to produce the micropropagated plants does not affect the metabolic content and can be used to produce true-to-type plants of this species for commercial pharmaceutical use. **Acknowledgements:** The work was supported in part by National Institute of Drug Abuse (NIDA), Contract No. N01DA-0-7707. **References:** [1] Lata H, et al. (2008) In vitro cellular and developmental biology-Plant (In Press; DOI 10.1007/s11627-008-9167-5). [2] Lata H, et al. (2009) Physiology and Mol Biol of Plants, 15(1): January 2009 (In Press).

P-5

Variations in Temperature Response of Photosynthesis in Drug and Fiber Type Varieties of *Cannabis sativa* L.

Chandra S¹, Lata H¹, Khan IA^{1,2}, ElSohly MA^{1,3}

¹ National Center for Natural Product Research, School of Pharmacy, University of Mississippi, University, MS, 38677, USA

² Department of Pharmacognosy, University of Mississippi, MS, 38677, USA

³ Department of Pharmaceutics, School of Pharmacy, University of Mississippi, University, MS 38677, USA

The effect of temperature on photosynthetic characteristics of three high yielding drug type (HP Mexican, MX and W1) and three fiber type (Kimpolty, Zolo 11 and Zolo 15) varieties of *Cannabis sativa*, originally from different agro-climatic zones worldwide were studied. The results clearly indicate that among three drug type clones, high potency Mexican (HP Mex) clone was found to be the most thermotolerant. Optimum temperature for photosynthesis (T_{opt}) was observed around 30 °C in HP Mex whereas, T_{opt} was observed in the range of 25 to 30 °C in W1 [1]. A comparatively lower value (25 °C) for T_{opt} was observed in MX. Among fiber type clones, T_{opt} was observed around 30 °C in Zolo 11 and Zolo 15 (Ukrainian origin) whereas, in Kimpolty (from Switzerland) it was observed around 25 °C. Differences observed in water use efficiency (WUE) among the clones at lower temperature were less pronounced at higher temperatures. Higher WUE and, lower stomatal conductance and transpiration in HP Mex indicate that this clone may be suitable for the plantation in relatively dry and exposed sites. Both stomatal and mesophyll components seemed to be responsible for the temperature dependence of photosynthesis (Pn) however, their magnitude varied with the clones. A two to five fold increase in dark respiration with an increase in temperature was observed in clones. However, higher increases were associated with clones having higher rate of photosynthesis, indicating an association between photosynthetic and respiratory rates. The results provide a valuable indication regarding clonal variations in temperature dependence of Pn in *Cannabis sativa* and may be used as a tool for initial selection of suitable clones for outdoor cultivation or to provide suitable indoor environment depending upon a particular variety/clone. **Acknowledgements:** The work was supported in part by National Institute of Drug Abuse (NIDA), Contract No. N01DA-0-7707. **References:** [1] Chandra S, et al. (2008) Physiology and Mol Biol of Plants, 14(4), October 2008 (in press).

P-6

Molecular Analysis of Genetic Stability of Micropropagated Plants of *Cannabis sativa* L. using ISSR Markers

Lata H¹, Chandra S¹, Techen N¹, Khan IA^{1,2}, ElSohly MA^{1,3}

¹ National Center for Natural Products Research, School of Pharmacy, The University of Mississippi, University, MS, 38677, USA

² Department of Pharmacognosy, School of Pharmacy, The University of Mississippi, University, MS, 38677, USA

³ Department of Pharmaceutics, School of Pharmacy, The University of Mississippi, University, MS, 38677, USA

An efficient micropropagation protocol was developed and plants of a high THC yielding elite variety (MX-1) of *Cannabis sativa* were

produced using nodal segments containing axillary buds [1]. The genetic stability of the micropropagated plants was evaluated up to thirty passages in culture and hardened in soil for 8 months using the method of Inter Simple Sequence Repeat (ISSR) DNA fingerprinting. ISSR profiles of micropropagated and hardened plantlets were compared with the mother plant grown indoor. A total of 15 ISSR primers resulted in 115 distinct and reproducible bands. All the ISSR profiles from micropropagated plants were monomorphic and similar to the mother plants. No variation was detected within the micropropagated plants. These results suggest that the culture conditions used for shoot proliferation are appropriate for clonal propagation of the elite variety of *C. sativa* as they do not seem to interfere with the integrity of the regenerated plants. This study is of high significance as these plants are selected to be used in the mass propagation for the production of biomass, as a starting material for the isolation of THC as a bulk active pharmaceutical. **Acknowledgements:** The work was supported in part by National Institute of Drug Abuse (NIDA), Contract No. N01DA-0-7707. **References:** [1] Lata H, et al. (2008) In vitro Cellular and Developmental Biology-Plant, (In Press; DOI 10.1007/s11627-008-9167-5)

P-7

A Rapid Microdistillation Method for the Texas and Turkish *Salvia* Species and Their Genetic Profiles

Techen N¹, Tabanca N², Demirci B³, Turner JL⁴, Ponders C⁵, Akaydin G⁶, Demirci F³, Pan Z², Khan IA^{1,7}, Wedge DE², Baser KHC³

¹ National Center for Natural Products Research, Research Institute of Pharmaceutical Sciences, The University of Mississippi, University, MS, 38677, USA

² USDA-ARS-NPURI, The University of Mississippi, University, MS, 38677, USA

³ Department of Pharmacognosy, Faculty of Pharmacy, Anadolu University, 26470, Eskisehir, Turkey

⁴ Dallas Arboretum and Botanical Garden, Dallas, TX, 75218, USA

⁵ USDA-ARS, Southern Horticultural Laboratory, Poplarville, MS, 39470, USA

⁶ Department of Biology Education, Hacettepe University, 06532 Ankara, Turkey

⁷ Department of Pharmacognosy, School of Pharmacy, The University of Mississippi, University, MS, 38677, USA

The leaves of *Salvia* (Labiatae) species have a reputed use in traditional medicine. They are known as 'ada cayi' in Turkey and consumed as a hot drink. Sage leaves are used traditionally as a tonic, stimulant, carminative, antiseptic, for inflammations in the mouth and for infections in Turkey [1]. *Salvia madrensis*, *Salvia longispicata* x *farinacea*, *Salvia greggii*, *Salvia roemeriana*, *Salvia farinacea*, *Salvia leucantha*, *Salvia splendens*, *Salvia coccinea* from Dallas Arboretum & Botanical Garden and *Salvia candidissima*, *S. forskahlei*, *S. tchihatcheffii*, *S. wiedemanni*, *S. napifolia*, *S. cryptantha*, *S. fruticosa* from Turkey were subjected to microdistillation technique and their chemical compositions were analyzed using both gas chromatography (GC-FID) and gas chromatography-mass spectrometry (GC-MS) techniques. The differences in chemical composition of 15 *Salvia* species will be presented in this study. Short Single Repeat (SSR) Microsatellite loci are highly informative genetic markers useful for population genetic studies, molecular breeding and parentage determination. Microsatellites, short nucleotide (1–6 bp) sequences, are the current DNA marker of choice because of their highly polymorphic distribution within the genome. In this study we also report the isolation and characterization of microsatellites from 15 *Salvia* species from Turkey and other countries. The utility of SSR loci as possible method in determining chemotype and authentication of plant species was evaluated and discussed. **References:** [1] Demirci B, Tabanca N, Baser KHC (2002) Flavour Fragr. J. 17: 54–58.

P-8

Chemical Characterization and Genomic Profiling of *Achillea biebersteinii* from Various Localities in Central Turkey

Techen N¹, Tabanca N², Demirci B³, Gurbuz I⁴, Pan Z², Khan IA^{1,5}, Demirci F³, Wedge DE², Baser KHC³

¹ National Center for Natural Products Research, Research Institute of Pharmaceutical Sciences, The University of Mississippi, University, MS, 38677, USA

² USDA-ARS-NPURL, The University of Mississippi, University, MS, 38677, USA

³ Department of Pharmacognosy, Faculty of Pharmacy, Anadolu University, 26470, Eskisehir, Turkey

⁴ Department of Pharmacognosy, Faculty of Pharmacy, Gazi University, 06330 Ankara, Turkey

⁵ Department of Pharmacognosy, School of Pharmacy, The University of Mississippi, University, MS, 38677, USA

Herbal teas prepared from selected *Achillea* (Asteraceae) species are used in traditional Turkish medicine as diuretic, emmenagogue (menstrual flow stimulant), aid in wound healing, treatments for abdominal pain, and used to counteract diarrhea and flatulence [1]. *Achillea biebersteinii* is locally known as "Ayvadana, Sari civanperceci" in Turkey. The aerial parts of five *Achillea biebersteinii* accessions were collected from different locations in Central Turkey to study the essential oil composition and their genetic fingerprinting. Hydrodistilled essential oils were analyzed by GC-FID and GC/MS techniques. Essential oils from plants obtained from Konya region were rich in 34–37% 1,8-cineole and oil from plants obtained from the Ankara region contained 27% *p*-cymene as the major constituent. *Achillea* oils were also evaluated for their antimalarial, antimicrobial and antifungal activities. Detailed chemical profile will be presented in this study. An increasing application of DNA fingerprinting is the use of marker assisted breeding and authentication/identification of (plant) species used in pharmacology or in commercial available food products. In this study we also describe the construction of a genomic library from *Achillea biebersteinii* enriched for Short Single Repeat (SSR) microsatellite loci. We have isolated several hundred clones with distinct SSRs fragments and designed oligonucleotides based on the identified sequence. The effectiveness of genetic markers as possible methods in determining specific chemotypes and authentication of plant species from Turkey and USA was evaluated and discussed in this study. **References:** [1] Konyalioglu S, Karamenderes C (2005) Journal of Ethnopharmacology, 102: 221–227.

P-9

Genomic Profiling of *Cannabis sativa* L.

Techen N¹, Chandra S¹, Lata H¹, ElSohly MA^{1,2}, Khan IA^{1,3}

¹ National Center for Natural Product Research, School of Pharmacy, University of Mississippi, University, MS, 38677, USA

² Department of Pharmaceutics, School of Pharmacy, University of Mississippi, University, MS, 38677, USA

³ Department of Pharmacognosy, University of Mississippi, MS, 38677, USA.

Cannabis sativa is an interesting crop for several industrial uses. It has been used for fiber (hemp), for medicinal purposes, and as a psychoactive. Although the main psychoactive chemical compound in *Cannabis* is Δ^9 -tetrahydrocannabinol (THC), the plant is known to contain about sixty cannabinoids, however, most of these "minor" cannabinoids are produced in trace amounts. Short Single Repeat (SSR) Microsatellite loci are highly informative genetic markers useful for population genetic studies, linkage mapping and parentage determination. Methods to identify novel microsatellite loci commonly use subtractive hybridization to enrich small-insert genomic libraries for repeat sequences. We have developed a method that allows highly efficient ligation to genomic DNA and improves recovery of sequences after subtractive hybridization to biotinylated oligos. The method improves current repeat-enrichment strategies, resulting in representative small-insert libraries with a very high proportion of positive clones. The effectiveness of

genetic marker associated to determining three different chemotypes in *Cannabis* was evaluated and discussed, as possible method in marker-assisted breeding of *Cannabis* in the pharmaceutical field.

P-10

Application of DNA Barcoding to the Medicinal Plants of the Araceae Family

Luo K^{1,2}, Chen SL², Chen KL¹, Song JY², Yao H²

¹ Hubei University of Chinese Medicine, Wuhan 430061, P.R. China

² Institute of Medicinal Plant Development, Peking Union Medical College & Chinese Academy of Medical Sciences, Beijing 100193, P.R. China

The medicinal plants of the Araceae family are distributed widely throughout China and more than half of them are medicinal plants, whereas materials of similar morphology and chemical fingerprints are often misidentified. DNA barcoding is a new technique that uses DNA sequences from a small fragment of the genome to identify species. Five specific DNA regions (*matK*, *rpoB*, *rpoC1*[1], *rbcl*, *psbA-trnH*[2]) of 95 samples of 34 genus were amplified and sequenced. We found that the *psbA-trnH* is difficult to sequence through PCR product, because this region is A, T rich (70%, averaged). The amplification efficiency of *rbcl*, *matK*, *rpoB* and *rpoC1* were 87.4%, 94.7%, 98.9%, 100%, respectively. However the *matK* was variable enough to identify species, and the intra-specific divergence from 0 to 0.20% was significantly less than the inter-specific divergence from 0.42% to 19.4%. The results indicate that the *psbA-trnH* is not suitable to identify the medicinal plants of the Araceae family. The *matK* can be used as a barcoding to identify all species of Araceae. **Acknowledgements:** This work is supported by the International Cooperation Program of Science and Technology (No.2007DFA30990) and the Special Founding for Healthy Field (No.200802043) **References:** [1] Chase MW, et al. (2007) A proposal for a standardized protocol to barcode all land plants 56(2): 295–299. [2] Kress WJ, et al. (2005) Proceedings of the National Academy of Sciences USA 102: 8369–8374.

P-11

Relationship between DNA Barcoding and Chemical Classification of *Salvia* L. Medicinal Herbs

Han JP¹, Shi LC¹, Li MH³, Yao H¹, Song JY¹, Xu HX², Sun C¹, Chen SL^{1,4}

¹ Institute of Medicinal Plant Development, Peking Union Medical College & Chinese Academy of Medical Sciences, Beijing, 100193, P.R. China

² Chinese Medicine Laboratory, Hong Kong Jockey Club Institute of Chinese Medicine, Hong Kong, P.R. China

³ Baotou Medical College, Inner Mongolia, 014000, P.R. China

⁴ Hubei University of Chinese Medicine, Wuhan, Hubei, 430065, P.R. China

In China, over 20 *Salvia* species have been used as Danshen in traditional folk medicine [1]. The rapid and accurate identification of species is critical to *Salvia* L. medicinal herbs. DNA barcodes and chemical fingerprint are two approaches that have recently garnered much attention [2, 3]. Here we compared these two methods for identification of the genus of *Salvia* L. First, we sequenced the nucleotide sequences of the internal transcribed spacer region 2 amplified from 32 medicinal plants belonging to *Salvia* L. and seven other groups of labiatae medicinal plants. By using neighbor joining analyses, phylogenetic trees were mapped by their sequence diversity. Secondly, we tested the water-solution bioactive components (Rosmarinic acid, Lithospermic acid and Salvianolic acid B.) and lipid soluble components (Tanshinone I and Cryptotanshinone) of every sample by HPLC. Additionally, we compared the relationship between the sequence of ITS2 and the components of every branch in NJ tree, and found regular relationship between them. By contrast, DNA barcoding was sequencing-based and therefore could provide more accurate and fast results in large-scale studies. This is the first paper to show the relationship between DNA barcoding and chemical components. **Acknowledgements:** Thanks go

to the International Cooperation Program of Science and Technology (No.2007DFA30990) and the Special Founding for Healthy Field (No. 200802043), for supporting the study. **References:** [1] Li, MH, et al. (2008) J Ethnopharmacol, DOI: 10.1016/j.jep.2008.09.013. [2] Miller SE (2007) PNAS, 104: 4775–4776. [3] Lahaye R, et al. (2008) PNAS, 105: 2923–2928.

P-12

Using DNA Barcodes to Identify Rosaceae

Pang XH¹, Chen SL¹

¹ Institute of Medicinal Plant Development,
Chinese Academy of Medical Sciences & Peking Union
Medica College, 100193 Beijing, China

DNA barcoding has recently been proposed as a technique that employs a short, standardized gene region to identify species. DNA barcoding is well established in animals because of a widely appropriate sequence for them, the cytochrome oxidase 1 [1], but there is not any universally accepted barcode for plants till now. Therefore, the primary task for barcoding plants is to find more useful barcodes that can identify as many species as possible. Medicinal plants have been used as traditional Chinese drugs for treating diseases, some of them are similar in morphology, and are often misidentified by chemical fingerprints. Rosaceae includes many medicinal plants with similar morphology and are usually hard to be identified. Here, we chose five potential barcodes, Universal Plastid Amplicon (matK, rpoB, rpoC1, rbcL) and the nuclear ribosomal DNA (rDNA) internal transcribed spacer (ITS), to identify species from different genera in Rosaceae. The results suggest that the nuclear ribosomal DNA (rDNA) internal transcribed spacer (ITS) is a candidate to discriminate all of plant species in Rosaceae. **Acknowledgements:** We thank all my teachers and classmates in our laboratory very much for their help. **References:** [1] Kress WJ, et al. (2005) PNAS, 102: 8369–8374.

P-13

Authentication of the Medicinal Plants in Fabaceae by DNA Barcoding Technique

Gao T¹, Chen SL¹

¹ Institute of Medicinal Plant Development,
Chinese Academy of Medical Sciences, Peking Union
Medical College, Beijing, 100193, China.

Fabaceae is the third largest family of flowering plants, with a large number of medicinal plants. However, it is arduous to identify some of the species in this family because of morphological similarity and frequent variation. The DNA barcode, a short DNA sequence originating from the genome, was first investigated for the medicinal plant in Fabaceae. Now we have completed 86 species of medicinal plants in Fabaceae including over 30 genera. Through six candidates, promising markers, four coding (*rpoB*, *rpoC1*, *rbcL*, *matK*) and two noncoding (ITS, ITS2) chloroplast regions, we identified potential barcodes of the medicinal plants in Fabaceae by comparing DNA barcoding sequences. The results indicated, efficiency of amplification for six candidate DNA barcodes range from 100% (ITS2) to 93% (*matK*). Intraspecific variation and interspecific variation for six chloroplast regions derived Wilcoxon signed rank tests of divergence showed that *rpoC1* was the least discriminatory region, while ITS2 was the potential candidate of medicinal plant barcoding in Fabaceae in our study. Overall, our findings showed that DNA barcoding is an efficient and powerful tool for the identification of the medicinal plants in Fabaceae. **Acknowledgements:** This work is supported by the International Cooperation Program of Science and Technology (No. 2007DFA30990) and the Special Founding for Healthy Field (No. 200802043). **References:** [1] Gregory TR, (2005), Nature, 434: 1067. [2] Kress WJ, Erickson DL (2007) PLoS One, 2: 508. [3] Kress WJ, Erickson DL (2008) Proceedings of the National Academy of Sciences, USA, 105: 2761–2762. [4] Frézal L, Leblois R (2008) Infection, Genetics and Evolution, 8: 727–736. [5] Yao H, et al. (2008), Planta Medica (Accepted). [6] Lahaye R, et al. (2007) PNAS, 1–6.

P-14

Genetic and Metabolic Studies of Cannabinoids in Standardized Medicinal Cannabis sativa

Muntendam R¹, Erkelens T², Kayser O¹

¹ Department of Pharmaceutical Biology, University of Groningen, Groningen University for Drug Exploration (GUIDE), A. Deusinglaan 1, 9713AV Groningen, The Netherlands
² Bedrocan BV, Veendam, The Netherlands

In this research we investigated the biosynthesis and accumulation of cannabinoids during the growth phases of Cannabis sativa leaves and flowers. Flowers from standardized indoor breeding were analyzed for transcription and expression of identified genes [1–5] from the cannabinoid pathway and the accumulation of the cannabinoid metabolites [6]. The correlation between the various measurements should give more information on the regulation of the cannabinoid production process within the plant. Plant samples were taken randomly during standardized cultivation. Every week, for eight weeks in a row, three plants were sampled, and materials were treated for analysis by QRT-PCR, HPLC, and 2D-electrophoresis. With QRT-PCR the transcription of CBDA-(BAF65035), THCA-(BAE48253) and olivetol synthase (BAG14339) genes were quantified against cloned genes. 2D-electrophoresis was used to detect any specific protein expression during the cultivation period. From this ongoing study, we have indicated that the amount of THCA in the leaves stays in certain ranges throughout the sampling period and is not dependant on the vegetative or flowering status of the plant. In contrast, the content of THCA in the flowers is depending on the growth period, which is in line with previously reported data on the correlation of trichoma and cannabinoids. The information obtained from this study is used as a profound basis for further genetic and metabolic analysis. **References:** [1] Kim JS, et al. (2006) Biotechnol Lett. 28(13): 999–1006. [2] Sirikantaramas S, et al. (2005) Plant Cell Physiol. 46(9): 1578–1582. [3] Sirikantaramas S, et al. (2004) J Biol Chem. 279(38): 39767–39774. [4] Morimoto S, et al. (1998) Phytochemistry, 49(6): 1525–1529. [5] Taura F, et al. (1996) J Biol Chem. 271(29): 17411–17416. [6] Fellermeier M, et al. (2001) Eur J Biochem. 268(6): 1596–1604.

P-15

Profiling Changes in Gene-to-Metabolite Networks for Rosmarinic Acid and its Derivative Biosynthesis in Salvia miltiorrhiza Hairy Root Cultures Treated with Elicitors

Xiao Y¹, Yi B¹, Duan YB¹, Chen JF¹, Liu Y¹, Chen WS^{1,3}, Zhang L²

¹ Department of Pharmacy, Changzheng Hospital, Second Military Medical University, Shanghai 200003, P.R. China
² Department of Pharmacognosy, School of Pharmacy, Second Military Medical University, Shanghai 200433, P.R. China
³ Modern Research Center for Traditional Chinese Medicine, Second Military Medical University, Shanghai 200433, P.R. China

Salvia miltiorrhiza Bunge (Dan-shen in Chinese), is a commonly used traditional Chinese medicine for improving body function, as well as for the treatment of cardiac symptoms. The phenolic acids such as rosmarinic acid (RA) and its derivative lithospermic acid B (LAB) aroused scientists interest in the last twenty years because of their notable pharmacological activities [1]. As for *S. miltiorrhiza*, hairy root cultures have been suggested to be more stable and efficient than cell suspension cultures in active constituent accumulation [2]. In our present study, we found that methyl jasmonate (MeJA) and Ag⁺ could greatly enhance the phenolic acids at various levels. Meantime, several related gene transcripts and metabolites (intermediates) accumulations involved in RA synthesis pathway (1), in response to elicitors, were determined by real-time quantitative PCR and liquid chromatographic-tandem mass spectrometry, respectively. Therefore, a gene-to-metabolite network for understanding of global responses to abiotic elicitation in *S. miltiorrhiza* is established, and a potential (putative) biosynthesis process from RA to LAB is presumed (2), which is now under intensive investigation by analysis of differential expression protein and precursor feeding experiment in our laboratory. **Acknowledgements:** This re-

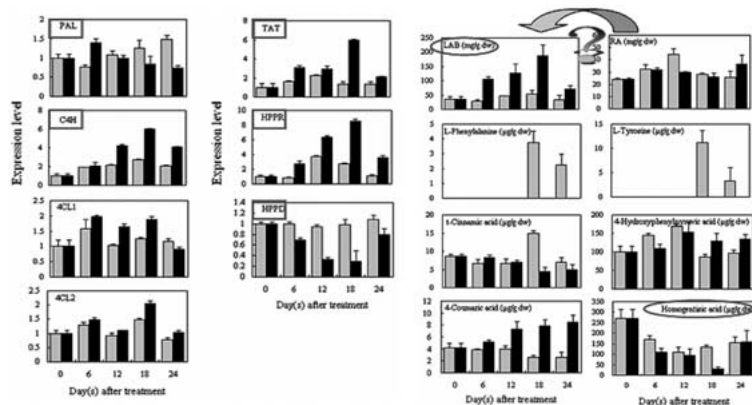

(1)

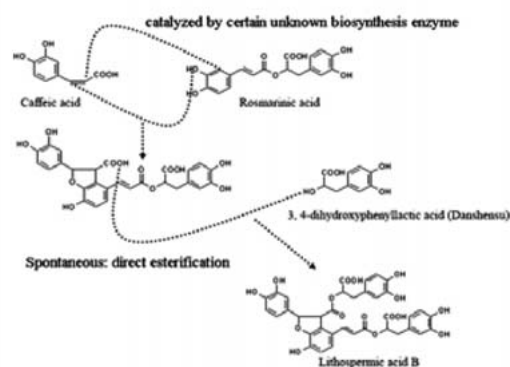

(2)

search was financially supported by National Natural Science Foundation of China (20572130, 30600807). **References:** [1] Liu AH, et al. (2006) *J Pharm Biomed Anal*, 41: 48–56. [2] Chen H, et al. (1999) *J Ind Microbio Biotechnol*, 22: 133–138.

P-16

Taxonomic Clarification on *Turnera diffusa* Ward and its Demarcation from “False Damiana” using Fluorescence, Scanning Electron Microscopy, HPTLC and UPLC

Joshi VC¹, Rao AS¹, Wang YH¹, Avula B¹, Khan IA^{1,2}

¹ National Center for Natural Products Research, School of Pharmacy, The University of Mississippi, University, MS 38677, USA

² Department of Pharmacognosy, School of Pharmacy, The University of Mississippi, University, MS 38677, USA

“Damiana” is used traditionally as stimulant, aphrodisiac, nerve tonic, diuretic, laxative, and for kidney, menstrual and pregnancy disorders [1]. The ancient Mayans used it to treat giddiness and loss of balance [2] while the Mexican Indians made a beverage for its reputed aphrodisiac properties [3]. Though “damiana” has a long history of usage, confusion over its precise identity and nomenclature still exists. According to British Herbal Pharmacopoeia (1996) “*Damiana folium*” consists of dried leaves of *Turnera diffusa* Willd. Ex Schults. var *aphrodisica* and related species. Beside “false damiana” are often used as substitutes for damiana. The name “false damiana” is referred to both *T. ulmifolia* (Turneraceae) as well as for *Aplopappus disciodse* DC (Asteraceae) [4]. We observed that existing studies were not opportune and dependable in providing the exact identity of *T. diffusa* and discriminating it from the known “false damiana” species. In the present study we have provided taxonomic account on *Turnera diffusa* and furnished easy and reliable method to authenticate *T. diffusa* and to detect its possible substitute’s using morphological and micro-morphological characteristics, with the aid of light, fluorescent and scanning electron microscopy. For the first time HPTLC, and UPLC comparative account has also been provided for the three species. These three methods in combination can be a useful tool in authentication of *T. diffusa* and for the detection of its adulterants. **Acknowledgements:** This research is funded in part by “Botanical Dietary Supplements: Science-Base for Authentication” funded by Food and Drug Administration grant number FD-U-002071–01. **References:** [1] Kumar S, et al. (2006) *J of Medicinal Food*, 9: 254–260. [2] Martinez M, (1944) *Las Plantas medicinales de Mexico*. Ediciones Botas. Mexico. [3] Lowry TP, (1984) *Psychoactive Drugs*, 16: 267–268. [4] Grieve M, (ed. Leyel, CF), (1996) *A Modern Herbal*, Barnes & Nobel, New York.

P-17

Identification of Weight Loss Supplement Cha De Bugre

Joshi VC¹, Khan IA^{1,2}

¹ National Center for Natural Products Research, School of Pharmacy, The University of Mississippi, University, MS 38677, USA

² Department of Pharmacognosy, School of Pharmacy, The University of Mississippi, University, MS 38677, USA

The use of dietary supplement Cha De Bugre for weight loss/appetite suppressant is getting increasingly popular. The efficacy and safety of these products depends on the quality and accurate identity of raw material. Along with taxonomic evaluation, macroscopic, microscopic and organoleptic assessment is one of the reliable, consistent, competent and cost effective methods in authentication of raw material [1]. In Brazil *Cordia salicifolia* Cham (Boraginaceae) is commonly referred to as cha de bugre or coffee of the woods. On the other hand *Casearia silvestris* Sw. (Flacourtiaceae) is also frequently referred to as congonhas-de-bugre and is often substituted for *Cordia salicifolia* due to the resemblance in its common name. In the present study we have provided a detailed monographic account (involving taxonomy, species distribution, macro and micro-morphological evaluation, analysis of powder and shifts) for the two species. We also analyzed commercially available cha de bugre samples. **Acknowledgements:** This research is funded in part by “Botanical Dietary Supplements: Science-Base for Authentication” funded by Food and Drug Administration grant number FD-U-002071–01. **References:** [1] Joshi V, Khan I, (2006) ed. Khan I, Smillie T, Craker L, Gardner Z, in *Proceedings of the Fourth International Conference on Quality and Safety Issues Related to Botanicals*, ISHS. Leuven, Belgium, Acta Horticulturae 720. [2] Siqueira V, et al. (2006) *Brazilian Archives of Biology and Technology*, 49: 215–218.

P-18

Authentication of *Caralluma adscendens* var. *fimbriata* (Wall.) Gravelly & Mayur

Joshi VC¹, Rao AS¹, Wang YH¹, Avula B¹, Khan IA^{1,2}

¹ National Center for Natural Products Research, School of Pharmacy, The University of Mississippi, University, MS 38677, USA

² Department of Pharmacognosy, School of Pharmacy, The University of Mississippi, University, MS 38677, USA

Caralluma is an edible succulent plant used by tribes in India to suppress hunger and enhance endurance [1]. It is a new arrival in the family of succulent plants that are becoming increasingly popular for their appetite suppressant and weight loss properties as well as their ability to lower blood sugar. Accurate identity of the raw material is critically important, to ensure the efficacy and safety of these products. Available herbal monographs lack information on *Caralluma*. The present study, details the macroscopic and microscopic evaluation of *Caralluma adscendens* var. *fimbriata*

along with details on its distribution and nomenclature. **Acknowledgements:** This research is funded in part by "Botanical Dietary Supplements: Science-Base for Authentication" funded by Food and Drug Administration grant number FD-U-002071-01. We would like to thank Dr. Aparna Watve and Dr. Gaikwari, from Hi-Tech Bio laboratories, India for providing authenticated plant material. **References:** [1] Kuriyan R, et al. (2007) *Appetite* 48: 338–344.

P-19

Development of the NC Arboretum Medicinal Plant Germplasm Repository for Collaborative Research and Conservation

McCoy JA¹

¹ NC Arboretum, 100 Frederick Law Olmsted Way Asheville, NC 28806-9315, 828-665-2492 ext. 268, jmcocoy@ncarboretum.org

The NC Arboretum Medicinal Germplasm Facility will be a collaborative effort by public and private organizations to advance the conservation, authentication, and cultivation of medicinal plants by collection and long-term storage of germplasm and their associated documentation. Germplasm will include but not be limited to seed, DNA, pollen, and entire plants when applicable. In addition soil samples, voucher specimens, and representative tissue samples for chemical analysis will be collected and stored. Located at the NC Arboretum in Asheville, in situ collection efforts commenced in spring 2008. The mission of the NCAM will include: 1.) the long-term conservation of diverse medicinal germplasm through field collection and acquisition; 2.) Germination and seed viability testing following pre-established IOSA protocols; 3.) establishing collaborative germplasm-related research projects with regional co-operators; and 4.) encouraging the use of the collections and associated information for phytopharmaceutical screening, crop improvement and product development. Comprehensive accession information including passport data, images, site maps, and experimental results will be maintained via an interrelational database. Conservation via seed collection and storage will play a central role in protecting the high levels of genetic diversity available in our extraordinarily rich bioregion. The collections will be suitable for a wide variety of research purposes including but not limited to analysis of metabolites of interest for pharmaceutical purposes, cultivar breeding studies, and genetic population analysis.

P-20

Building Partnership for Drug and Ag Discovery and Conservation of the Natural Resources in Brazil

Cerdeira AL¹, Walker LA², Moraes RM², Khan IA², França SC³, Pereira AMS³, Pimentel FA⁴, Matallo MB⁵

¹ Brazilian Department of Agriculture, Embrapa/Environment, C.P. 69, Jaguariúna, SP, 13820-000, Brazil, cerdeira@cnpma.embrapa.br

² National Center for Natural Products Research, The University of Mississippi, University, MS, 38655, USA

³ University of Ribeirão Preto (UNAERP), Ribeirão Preto, SP, 14096-380, Brazil

⁴ Brazilian Department of Agriculture, Embrapa/Tropical Agroindustry, C.P. 3761, Fortaleza, CE, 60515-110, Brazil

⁵ Biological Institute of Campinas, Rodovia Heitor Penteado Km 3,5 -Campinas, SP, 13001-970, Brazil

Cerrado, Brazilian savanna, covers 2 million km², representing 23% of the land surface of the country. It occupies the central part of Brazil, from the margin of the Amazonian forest to outlying areas in the southern states of Sao Paulo. According to Dias' [1] estimation, the Cerrado contains 160,000 species of plants, fungi and animals. This proposed research program will expand and upgrade the conservation effort. The project will: 1) build an International Partnership on Conservation and Natural Product Discovery; 2) map and protect the genetic resources by establishing germplasm bank of two endemic families Leguminosae and Combretaceae; 3) search for new pharmaceuticals and agrochemicals to control tropical diseases, and agricultural pests and pathogens, 4) create an Eco-extract-library and *ex situ* collections for future studies; 5) es-

tablish a microbial library of plant associated microorganisms. As the establishment of *in vitro* germplasm bank progresses, endophytic microbes commonly associated with plants will outgrow the host tissues and allow us to detect and identify them. Some of these organisms are responsible for production of secondary metabolites [2, 3]. Clonal propagation by *in vitro* methods will supply the biomass for fractionation and isolation of the active metabolite (s) and future developments. In addition, micropropagation will provide a unique opportunity to identify and evaluate the contribution of plant associated microorganism to the biological properties. **References:** [1] Dias BF, (1992) Manejo e Conservação dos Recursos Naturais Renováveis. Funatura, Brasília. DF. Brazil. [2] Lata H, et al. (2006) *Plant Cell Tiss Org*, 85: 353–359. [3] Strobel G, (2006) *Curr Opin Microbiol*, 9: 240–244.

P-21

Antifungal Activity of *Stryphnodendron adstringens* (Mart.) Extracts

Sieira VC¹, Cerdeira AL², Martinez-Ross NM³, França SC¹, Pereira PS¹, Bertoni B¹, Fachin AL¹, Pereira AMS¹

¹ University of Ribeirão Preto (UNAERP), Ribeirão Preto, SP, 14096-380, Brazil

² Brazilian Department of Agriculture, Embrapa/Environment, C.P. 69, Jaguariúna, SP, 13820-000, Brazil, cerdeira@cnpma.embrapa.br

³ São Paulo University, Department of Genetics, Ribeirão Preto Medical School, Ribeirão Preto, SP, 14049-900, Brazil

Stryphnodendron adstringens (Mart.) Coville, is a medicinal plant that belongs to Mimosoideae. It is also known as barbatimão. Its aqueous extract has anti-inflammatory and antimicrobial properties [1]. This study was conducted to evaluate the phenols and tannins content and the antifungal activity of the aqueous extract against *Trichophyton rubrum*. A clinical isolate of *T. rubrum* (ATCC-MYA3108) was obtained from a patient admitted to the University Hospital of Ribeirão Preto University, SP, Brazil. The mutant strain *TruMDR2* was obtained from the disruption of the *TruMDR2* gene from isolate MYA3108. Phenol concentrations were determined by colorimetric method and the antifungal potential was determined in bioassays measuring the minimal inhibitory concentration (MIC). The antifungal activity of the extracts was confirmed against *T. rubrum*. The aqueous extract *S. adstringens* contains phenols and tannins and showed a minimal inhibitory concentration (MIC) of 156 µg/mL for both isolates of *T. rubrum* (Table 1), as compared to fluconazole at 75 µg/mL. The fractions were less active than the whole extract suggesting that the activity is related to possible interactions of compounds not due to a specific metabolite, as mentioned by Bezerra et al. [2]. **References:** [1] Souza C, Felfili J, (2006) *Acta Botanica Brasílica*, 20: 135–142. [2] Bezerra JCB, et al. (2002) *Fitoterapia*, 73: 428–430.

Table 1 Minimal inhibitory concentration (MIC) µg/mL of water extract and fractions of *S. adstringens* against two strains of *Trichophyton rubrum*. (Standard Deviation 6.78).

Isolates	Water extract	Fraction I	Fraction II	Fraction III	Fluconazole
MYA-3108	156	1250	1250	1250	75
TruMDR2	156	312	625	1250	7575

P-22

Ecological Suitability of *Arctium lappa* L. and its Suitable Cultivation Regions in China

Dou DQ¹, Kang TG¹, Xu L¹, Xie CX², Chang Y³, Lv Z¹, Kang K¹, Liu YN¹

¹ College of Pharmacy, Liaoning University of Traditional Chinese Medicine, 77 Life One Road, DD port, Dalian 116600, China

² Institute of Medicinal Plant Development, Chinese Academy of Medical Sciences, Peking Union Medical College, Beijing 100094, China

³ Shenyang Ecological Institute, Chinese Academy of Science, Shenyang 110016, China

Dao-Di-Yao-Cai means the Chinese materia medica with highest quality. It is a unique index used for the evaluation of Chinese materia medica in traditional Chinese medicine and is nearly completed after a long-time clinical experience evaluation of practitioners. The fruit of *Arctium lappa* is a generally-used herbal medicine in TCM for the treatment of flu, diabetes, etc. [1]. Modern research indicated that the lignans from the fruit of *A. lappa* account for most of the associated activity, especially the compound arctiin, that possesses anti-virus, anti-cancer and anti-diabetes activity by way of its primary metabolite arctigenin [2]. To explore the ecological suitability and appropriate cultivation regions, 34 samples of *A. lappa*, including fruits and its rhizosphere soil, were distributed to four principal cultivation regions for *A. lappa* in China. The contents of arctiin and arctigenin were selected as index markers to measure the pharmacological actions of the fruits of *A. lappa* and were determined by HPLC. In addition to these markers, the mass of a thousand seed, seed germination rate and energy, were chosen as indicators to evaluate the seed quality. The trace elements in soil and seeds were determined, the pH, total nitrogen and anions, such as Cl⁻, NO₃⁻, CO₃²⁻, SO₄²⁻ etc., in soils and rhizosphere microorganism were also analyzed. In addition the information on ecological factors encompassed longitude, latitude, temperature in January and July, slope orientation, rain volume/year was collected from GISTCM. The mathematic statistic analysis indicated that the heavy metals in soil increased the seed germination rate and the rain volume and temperature in July have a great effect on the content of arctiin. In addition a probiotic fungus and a inhibition fungus for the growth of *A. lappa* were identified from its rhizosphere soil. The suitable cultivation regions of *A. lappa* in China were divided based on the comparison of ecological suitable factors by TCMGIS system. **Acknowledgements:** Thanks for the funding of the National Eleventh-five year scientific Supporting plan, China. **References:** [1] Ju MJ, Dou DQ, Kang TG (2008) Modern Chinese Medicine, Vol. 10(2), p. 14–16. [2] Kang TG, Zhang WJ, Tanaka H, Kawamura T, Xu ZH, Yang SS, Zhao ZZ, Tanaka T. (2001) Natural Medicine, Vol. 55(3), p. 153.

P-23

Comparative Pharmacognostic Studies on *Aloe schweinfurthii* and *Aloe vera* (Aloeaceae) Leaves

Odeleye OM¹, Elujoba AA¹, Gbolade AA²

¹ Department of Pharmacognosy, Faculty of Pharmacy, Obafemi Awolowo University, Ile-Ife, Nigeria

² Department of Pharmacognosy, Faculty of Pharmacy, Olabisi Onabanjo University, Sagamu campus, Nigeria

In the modern era, herbs are found to be potential medicine for a variety of diseases. The usage of herbal drugs has increased in both developing and developed countries due their natural origin and minimal side effects. At present, the standardization of herbal drugs and herbal preparations is a priority area for Nigerian government and also Nigerian pharmaceutical industries. The *Aloe* plant (family, Aloeaceae) has been used all over the world for many years for various medicinal and health purposes. Studies on the macro- and micro-morphology of the leaves of *Aloe schweinfurthii* Baker and those of *Aloe vera* (Linn.) Burm. f., (a world acknowledged *Aloe* species), were carried out for comparative identification, authentication, chemo-microscopy, quantitative microscopy and phytochemical profiles that could be incorporated into their monographs in

the proposed Nigerian Herbal Pharmacopoeia (NHP). The results showed that both *Aloe* species possessed many similarities in epidermal characteristics with the ranunculaceous stomata that is more abundant in *A. schweinfurthii*. The TS of *A. vera* is clearly distinguished from *A. schweinfurthii* with the presence of calcium oxalate and raphides. Physical evaluation points out that the total ash value of the dried leaf, acid insoluble ash, water soluble ash, water soluble extractive and alcohol soluble extractive values of *A. schweinfurthii* are greater than that of *A. vera*. General phytochemical analysis of the methanolic extracts of both *Aloe* species revealed similarities in the presence of free and combined anthraquinones, starch, flavonoids, steroidal and phenolic compounds.

P-24

Constituents of *Momordica foetida* and Evaluation of their Antimicrobial Activity

Odeleye OM¹, Oyediji OA¹, Shode FO²

¹ Department of Chemistry, Faculty of Science and Agriculture, University of Zululand, KwaDlangezwa, 3886, South Africa

² School of Chemistry, University of KwaZulu-Natal, Westville Campus, P/Bag X54001 Durban 4000, South Africa, E-mail: odeleyeom@yahoo.com

Plants are a potential source of antimicrobial compounds. In this research, a plant from the family Cucurbitaceae was studied. *Momordica foetida* Schumch. Et Thonn is a climber commonly found in swampy areas in Central and Southern Africa. It has medicinal uses ranging from spiritual and psychiatric conditions to physical diseases. Drinking of aqueous leaf extracts of the plant for the treatment of malaria is reported in East and Central Africa [1,2]. The leaves were extracted using 70% ethanol and partitioned into hexane, chloroform, ethyl acetate, butanol and aqueous then screened for antimicrobial activity against 32 bacterial strains for both standard and isolates. Thus, ethyl acetate and chloroform fractions were chosen for further studies due to higher antimicrobial activity with minimum inhibitory concentration (MIC) values for 32 bacterial strains ranging from 0.156 and 2.5 mg mL⁻¹. Active fractions were further purified using chromatographic techniques. A detailed phytochemical investigation resulted into isolation of four curcubitane triterpenoids and flavonoids compounds from chloroform and ethyl acetate fractions respectively. The chemical structures of the isolated compounds were established through UV, IR, MS, ¹H, ¹³C, COSY and 2D NMR spectroscopic data. Antimicrobial investigations were carried out on the isolated compounds against 25 bacterial strains of which 3β,7β-dihydroxyl-cucurbita-5,23,25-trien-19-al followed by Kaempferol-3-O-β-D-glucopyranoside displayed minimum inhibitory concentration (MIC) values for 25 bacterial strains ranging from 7.8 to 250 μg mL⁻¹. **Acknowledgement:** We are grateful to the National Research Foundation and University of Zululand, South Africa for financial support. **References:** [1] Hakizamungu E, et al. (1992) J Ethnopharmacology 36: 143–146. [2] Rwangabo PC, (1993) La médecine traditionnelle au Rwanda. Edition Karthala and ACCT, Paris, France.

P-25

Chemical Composition and Biological Activities of Four *Achillea* Essential Oils from Turkey

Demirci B¹, Tabanca N², Wedge DE², Khan SI³, Khan IA^{3,4}, Aytac Z⁵, Baser KHC¹

¹ Department of Pharmacognosy, Faculty of Pharmacy, Anadolu University, 26470, Eskişehir, Turkey

² USDA-ARS-NPURI, University of Mississippi, University, MS 38677 USA

³ National Center for Natural Products Research, Research Institute of Pharmaceutical Sciences

⁴ Department of Pharmacognosy, School of Pharmacy, The University of Mississippi, University, MS 38677, USA

⁵ Department of Biology, Faculty of Science and Letters, Gazi University, 06500 Ankara, Turkey

The genus *Achillea* L. of Asteraceae is widely distributed and is represented by 42 species in Turkey. *Achillea* species comprise an im-

portant biological resource in folk medicine in the treatment of various diseases. In this study, the aerial parts of four *Achillea* species collected from different parts of Turkey were investigated for their essential oil composition and biological activity. Essential oils obtained by hydrodistillation were analyzed both by gas chromatography (GC) and gas chromatography-mass spectrometry (GC-MS). The main *Achillea* oil constituents were found as follows: *A. filipendula*: 43.8% santolina alcohol, 14.5% 1,8-cineole and 12.5% *cis*-chrysanthenyl acetate; *A. magnifolia*: 27.5% linalool, 5.8% spathulenol, 5.5% terpinen-4-ol, 4.7% α -terpineol and 4.7% β -eudesmol; *A. tenuifolia*: 12.4% artemisia ketone, 9.9% *p*-cymene, 7.1% camphor, 5.9% terpinen-4-ol, 4.7% caryophyllene oxide and 4.5% α -pinene; *A. tomentollum*: 9.4% camphor, 7.6% linalool, 7.1% α -terpineol, 5.3% *trans*-pinocarveol and 4.5% *trans*-verbenol. *Achillea* essential oils were investigated for antimalarial, antimicrobial and antifungal activities. *Achillea* oils showed no antibacterial activity against human pathogenic bacteria up to a concentration of 200 mg/mL. *A. tomentollum*, *A. tenuifolia* and *A. magnifolia* demonstrated mild antifungal activity against *Cryptococcus neoformans* (IC₅₀ = 45, 20 and 15 mg/mL, respectively). *A. magnifolia* and *A. filipendula* showed strong antimalarial activity against chloroquine sensitive D6 (IC₅₀ = 1.2 and 0.68 mg/mL) and chloroquine resistant W2 (IC₅₀ = 1.1 and 0.9 mg/mL) strains of *Plasmodium falciparum* without cytotoxicity to mammalian cells. *Achillea* oils also demonstrated weak non-selective antifungal activity against filamentous fungal plant pathogens *Colletotrichum acutatum*, *C. fragariae*, and *C. gloeosporioides*.

P-26

Essential Oil of *Inula sarana* Boiss. (Compositae), an Endemic Species of Turkey

Kirimer N¹, Demirci B¹, Duman H², Baser KHC¹

¹ Anadolu University, Faculty of Pharmacy, Department of Pharmacognosy, 26470 Eskisehir, Turkey

² Gazi University, Faculty of Science and Letters, Department of Biology, Ankara, Turkey

The genus *Inula* L. (Compositae) is represented in Turkey by 27 species and altogether 32 taxa of which eight are endemic [1–3]. *Inula* species are used as cholagogue, diuretic, antitussive, expectorant, anthelmintic and tonic in the Turkish folk medicine [4]. We have analyzed the hydrodistilled essential oil of *Inula sarana* Boiss., an endemic species of Turkey for the first time, by GC and GC/MS. 26 compounds were characterized representing 96.2% of the total composition. Main components were hexadecanoic acid (22.4%), 15-hexadecanolide (16.9%) and pentacosane (15.5%). **References:** [1] Davis PH, (Ed.) (1972), Flora of Turkey and the East Aegean Islands, Vol. 4, Edinburgh Univ. Press., Edinburgh. [2] Davis PH, et al. (1988), Flora of Turkey and the East Aegean Islands, Vol. 10, Edinburgh Univ. Press., Edinburgh. [3] Guner A, et al. (2000), Flora of Turkey and the East Aegean Islands, Vol. 11, Edinburgh Univ. Press., Edinburgh. [4] Baytop T, (1999), Therapy with Plants in Turkey (Past and Present), 2nd ed., Nobel Tip Basimevi, Istanbul.

P-27

Evaluation of the Angiogenic Activity of *Salvia triloba* L. Essential Oil

Koparal AT¹, Demirci B², Kaya M¹, Duali G², Butun S³, Baser KHC², Demirci E²

¹ Department of Biology, Faculty of Science,

² Department of Pharmacognosy, Faculty of Pharmacy, Anadolu University, 26470, Eskisehir, Turkey

³ Department of Chemistry, Faculty of Arts and Sciences, Eskisehir Osmangazi University, 26480, Eskisehir, Turkey

The genus *Salvia* L. (Lamiaceae) is represented by 89 species, thereof forty five endemic in Turkey [1]. Most of the *Salvia* species are used in various preparations and forms including the essential oil, in folk medicine among other uses for their anti-inflammatory, antipyretic, pain relieving and wound healing properties [1,2]. In this study, the herbal parts of *S. triloba* obtained from a commercial source cultivated in Izmir, Turkey, was investigated both for its (anti-)angiogenic properties and for its essential oil composition.

The essential oil was obtained by hydrodistillation, which was analyzed both by gas chromatography (GC) and gas chromatography-mass spectrometry (GC-MS). Main constituents were identified as 1,8-cineole (44%), camphor (12%), α -pinene (6%), β -pinene (6%), camphene (5%), and myrcene (3%). Using the *in vivo* CAM (Chorio Allantoic Membrane) assay the *Salvia* essential oil and its main constituents (0.5–100 μ g/pellet) as well as *in vitro* cytotoxicity (MTT), cell migration and tube formation tests (HUV-EC-C cell lines) of the essential oil (0.01–200 μ M) in comparison with standards such as suramin, thalidomide, cortisone were investigated for their antiangiogenic properties. As a result, *S. triloba* essential oil showed in both tests antiangiogenic activity in a dose dependent manner. **Acknowledgements:** TUBITAK – SBAG-107S262 (3756) for financial support. **References:** [1] Demirci B, et al. (2005) Pharmaceutical Biology 43: 666–671. [2] Kintzios SE (2000) Sage: The Genus *Salvia*. Series No. 14, Medicinal & Aromatic Plants. Abington, Gordon and Breach, Harwood Academic Publishers.

P-28

Insecticidal Activities and Composition of Essential Oils from the Medicinal Plant Garden at the National Center for Natural Products Research

Tabanca N¹, Weerasooriya AD², Demirci B³, Baser KHC³, Khan IA^{2,4}, Pridgeon J⁵, Becnel JJ⁵, Sampson BJ⁶, Werle CT⁶, Wedge DE¹

¹ United States Department of Agriculture, Agricultural Research Service, Natural Products Utilization Research Unit, The University of Mississippi, University, MS 38677, USA

² National Center for Natural Products Research, Research Institute of Pharmaceutical Sciences, The University of Mississippi, University, MS 38677, USA

³ Department of Pharmacognosy, Faculty of Pharmacy, Anadolu University, 26470, Eskisehir, Turkey

⁴ Department of Pharmacognosy, School of Pharmacy, The University of Mississippi, University, MS 38677, USA

⁵ Mosquito and Fly Research Unit, USDA-ARS-CMAVE, Gainesville, FL 32608, USA

⁶ USDA-ARS, Southern Horticultural Laboratory, Poplarville, MS 39470, USA

Plant-derived natural products are used world wide as biologically active pharmaceuticals and agrochemicals. Because of the necessity of finding safer insecticides in combination with the need of preventing environmental degradation and pollution, there is increasing interest in the use of plants as insecticides and insect feeding deterrents. In screening for new natural product-based insecticides, 12 different plant essential oils were tested for larvicidal activity against *Aedes aegypti* and insecticidal activity against azalea lace bugs, *Stephanitis pyrioides*. Study samples were obtained from the cultivated collection at the Medicinal Plant Garden at the NCNPR. Harvested samples were air-dried and processed to preserve volatile oils. All samples were subjected to water distillation using Clevenger-type apparatus to obtain essential oils. Twelve essential oils belonging to six families were analyzed by gas chromatography and gas chromatography-mass spectrometry techniques. Hydrocarbons and oxygenated derivatives of terpenoids, aldehydes, and phenylpropanoids comprised the volatile compounds in these essential oils. *Artemisia annua* essential oil resulted in 100% mortality at 30 ppm to 1st instar larvae of *Ae. aegypti*. Twelve oils tested at 1% concentrations exhibited 21–86% mortality against *S. pyrioides*. Detailed insecticidal results will be presented.

P-29

Bioactivity of 54 Essential Oil Extracts Topically Applied to Adult Azalea Lacebugs *Stephanitis pyrioides* (Scott) [Tingidae: Hemiptera]: A Rapid Bio-Pesticide Discovery Program

Sampson BJ¹, Werle CT¹, Tabanca N², Wedge DE², Kirker GT¹

¹ USDA-ARS, Southern Horticultural Laboratory, 810 Hwy 26 West, Poplarville, MS 39470, USA

² USDA-ARS-NPURL, The University of Mississippi, University, MS 38677 USA

Concern about genetic pest resistance and poisoning of non-target organisms are spurring the search for “softer” insecticides with greater selectivity and multiple modes of action. Essential oils are blends of secondary metabolites that serve plants as deterrents against insect herbivores, but remain relatively safe and even beneficial to vertebrates [1]. We used serial-time mortality bioassays to screen the essential oils from 54 representative plant species from 30 genera comprising 13 families of gymnosperms and angiosperms for bioactivity to laboratory-cultured azalea lace bugs, *Stephanitis pyrioides* (Scott). The principal developmental stages of bugs exposed to the essential oils were the adults-long-lived individuals that provide parental care to their leaf-infesting brood. Clever-type distillation extracted essential oils from dried plant material and lead components were purified and identified with gas chromatography-mass spectrometry (GC-MS). Oils were mixed with de-ionized water and a non-toxic emulsifier 0.9–9.0% dimethylsulfoxide (DMSO). All oil emulsions and sometimes their fractionated components were topically applied to adult bugs in randomized blocks at concentrations of 0, 650, 1300, 2500, 5000, and 10000 ppm. Overall bug mortality, as well as LD₅₀, LD₉₅ and LD₉₉ values were calculated after 1, 2, 3, 4 and 5 hours of exposure. Mortality data were analyzed using multivariate probits [1] and preliminary data show that 1% emulsions derived from oil of *Pelargonium* (94.5% bug-mortality), *Cinnamomum* (91.4%), *Hedychium* (85.9%) and *Tagetes* (81.8%) were more efficacious than the malathion-DMSO emulsions (66.1%) and are four promising botanical sources from which to isolate compounds useful for developing new biorational crop protectants. **Acknowledgements:** We thank the many generous colleagues who supplied us with plant material and extracts: Ikhlas A. Khan (USA), K. Husnu Can Baser (Turkey), Betül Demirci (Turkey), Gulmira Ozek (Turkey), Temek Ozek (Turkey), Aruna Weerasooriya, (USA), Zengping Gao (China), Sui Zhang (China), Jian Zhang (China), Peng Nan (China), Zhijun Liu (USA), Hamidou Sakhanokho (USA), Cecil Pounders (USA), Sandra Gray (USA), Christine Murphy (USA), Eugene K. Blythe (USA). **References:** [1] Sampson BJ, et al. (2005) *Pest Management Sci.*, 61: 1122–1128.

P-30

Chemical Composition and Biological Activities of Two *Angelica* Essential Oils from China

Wedge DE¹, Gao Z^{2,3}, Tabanca N¹, Demirci B⁴, Baser KHC⁴, Pridgeon J⁵, Becnel JJ⁵, Sampson BJ⁶, Werle CT⁶

¹ United States Department of Agriculture, Agricultural Research Service, Natural Products Utilization Research Unit, The University of Mississippi, University, MS 38677, USA

² National Center for Natural Products Research, Research Institute of Pharmaceutical Sciences, The University of Mississippi, University, MS 38677, USA

³ Department of Chinese Herbal Chemistry, School of Chinese Materia Medica, Beijing University of Chinese Medicine, Beijing, 100102 China

⁴ Department of Pharmacognosy, Faculty of Pharmacy, Anadolu University, 26470, Eskisehir, Turkey

⁵ Mosquito and Fly Research Unit, USDA-ARS-CMAVE, Gainesville, FL 32608, USA

⁶ USDA-ARS, Southern Horticultural Laboratory, Poplarville, MS 39470, USA

Chinese herbal medicine is an interesting subject for medicinal plant research. The root of *Angelica dahurica* (Baizhi in Chinese) and *Angelica pubescens* (Duhuo in Chinese) are well known in Traditional Chinese Medicine [1]. The pharmacological activities asso-

ciated with *A. dahurica* and *A. pubescens* include antibacterial, anti-febrile, antalgic, anti-spastic actions [2]. *Angelica dahurica* and *A. pubescens* (Umbelliferae) were fragmented and hydrodistilled to obtain the volatile compounds, and were then identified using gas chromatography and gas chromatography-mass spectrometry. Main *Angelica* oil constituents were found as follows: *A. dahurica*: 46.3% α -pinene, 9.3% sabinene, 5.5% myrcene, 5.2% dodecanol and 4.9% terpinen-4-ol and *A. pubescens*: 37.6% α -pinene, 11.6% *p*-cymene, 8.7% limonene and 6.7% cryptone. *Angelica* essential oils were examined for antimalarial, antimicrobial, antifungal and insecticidal activity. Antifungal activity of the essential oils from both *Angelica* species was non-selective at inhibiting growth and development of reproductive stroma of the plant pathogens *Colletotrichum acutatum*, *C. fragariae* and *C. gloeosporioides*. *Angelica pubescens* oil resulted in 40% mortality at 62.5 ppm to 1st instar larvae of *Aedes aegypti* at 24 h. *Angelica dahurica* oil at 1% concentration exhibited an 86.67% mortality in laboratory bioassays with azalea lace bugs, *Stephanitis pyrioides*, in comparison with *A. pubescens* oil at 44.0%. **References:** [1] The Pharmacopoeia Commission of P.R. China (2005) *The Pharmacopoeia of P.R. China*, 1: 69 and 185. [2] Wang YS (1983) *The Pharmacology and Application of Chinese Medicine*, People's Medical Publishing House, Beijing, 796.

P-31

The Chemical Composition and Biological Activities of *Notopterygium incisum* and *Notopterygium forbesii* Essential Oils from China

Wedge DE¹, Gao Z^{2,3}, Tabanca N¹, Demirci B⁴, Baser KHC⁴, Pridgeon J⁵, Becnel JJ⁵, Sampson BJ⁶, Werle CT⁶

¹ United States Department of Agriculture, Agricultural Research Service, Natural Products Utilization Research Unit, The University of Mississippi, University, MS 38677, USA

² National Center for Natural Products Research, Research Institute of Pharmaceutical Sciences, The University of Mississippi, University, MS 38677, USA

³ Department of Chinese Herbal Chemistry, School of Chinese Materia Medica, Beijing University of Chinese Medicine, Beijing, 100102 China

⁴ Department of Pharmacognosy, Faculty of Pharmacy, Anadolu University, 26470, Eskisehir, Turkey

⁵ Mosquito and Fly Research Unit, USDA-ARS-CMAVE, Gainesville, FL 32608, USA

⁶ USDA-ARS, Southern Horticultural Laboratory, Poplarville, MS, 39470, USA.

Roots and rhizomes of *Notopterygium incisum* and *Notopterygium forbesii* (Apiaceae) are popular in China for use as Traditional Chinese Medicines. Qiang huo is the Chinese name for the root of *Notopterygium* species. Historically, *Notopterygium Radix* and *Rhizome* have been used as diaphoretic, antifebrile and anodyne. In the course of screening for novel naturally occurring biologically active compounds in TCM plants, we distilled essential oils from *Notopterygium incisum* and *Notopterygium forbesii* roots and *N. forbesii* rhizomes. Water distilled essential oils were analyzed by GC-FID and GC-MS and evaluated for antimalarial activity, antimicrobial activity against human pathogenic bacteria and fungi, antifungal activities against plant pathogenic fungi and insecticidal activity. Forty, 68 and 59 constituents were characterized and identified representing 99.8% in *N. incisum* root oil, 91.4% in *N. forbesii* root oil and 96.5% in *N. forbesii* rhizome oil. Major components of *Notopterygium* essential oils were 26.5–42.6% α -pinene, 13.3–28.0% *b*-pinene and 4.5–8.9% limonene. *Notopterygium* oils showed no antimicrobial activity against human pathogenic bacteria or fungi, nor antimalarial activity against *Plasmodium falciparum*. *Notopterygium* oils demonstrated non-selective antifungal activity against the plant pathogens *Colletotrichum acutatum*, *C. fragariae*, and *C. gloeosporioides*. *Notopterygium forbesii* root oil produced 60% mortality to 1st instar larvae of *Ae. Aegypti* at 15.625 ppm. *Notopterygium* oils also showed weak insecticidal activity against *Stephanitis pyrioides*, with 1% concentrations exhibiting 33.33–64.00% mortality. **References:** [1] Fuquan J, et al. (2007) *Journal of Ethnopharmacology*, 111: 265–270.

Table 1

	1	2	3	4	5	6	7	8	9	10
R1	OMe	OMe	OMe	OMe	OMe	OMe	OMe	H	H	H
R2	OMe	OMe	OMe	OH	OH	OH	OH	H	H	H
R3	H	H	H	H	H	H	H	OMe	OMe	OMe
R4	H	H	OH	OH	H	OH	H	H	H	H
R5	H	OH	OH	H	OH	OH	H	H	H	OH
									C-2,3 dihydro	

P-32

Microbial Metabolites of 7, 8-dimethoxyflavone and 5-methoxyflavone

Herath W¹, Mikell JR¹, Khan IA^{1,2}¹ National Center for Natural Products Research, and² Department of Pharmacognosy, Research Institute of Pharmaceutical Sciences, School of Pharmacy, The University of Mississippi, University, MS 38677, USA

In selecting methoxyflavones as potential chemopreventive agents it is important to determine how susceptible they are towards metabolism [1]. Since, microorganisms are predictive models for mammalian drug metabolism we investigated prospectively the microbial metabolism of 7, 8-dimethoxyflavone (**1**) and 5-methoxyflavone (**8**) using 40 microorganisms. Transformation of 7, 8-dimethoxyflavone (**1**) by *Mucor ramannianus* produced five metabolites: 7, 8-dimethoxy-4'-hydroxyflavone (**2**), 3', 4'-dihydroxy-7, 8-dimethoxyflavone (**3**), 7, 3'-dihydroxy-8-methoxyflavone (**4**), 7, 4'-dihydroxy-8-methoxyflavone (**5**) and 8-methoxy-7, 3', 4'-trihydroxyflavone (**6**) (Table 1). It was however, completely converted to a single metabolite, 7-hydroxy-8-methoxyflavone (**7**) by *Aspergillus flavus*. 5-Methoxyflavone (**8**) when fermented with *Beauveria bassiana* gave a single product, 5-methoxyflavanone (**9**). Conversion of **8** with *Aspergillus alliaceus* yielded the metabolite, 4'-hydroxy-5-methoxyflavone (**10**). The structures were established by spectroscopic methods. Compound **1** showed moderate susceptibility towards oxidative metabolism [1]. 5-Methoxyflavone which was highly resistant to human microsomal oxidation [1] underwent transformation to metabolites **9** (7.47%) and **10** (71.92%) when fermented with *B. bassiana* and *A. alliaceus* respectively.

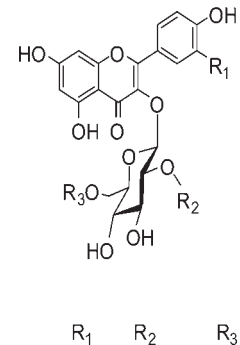
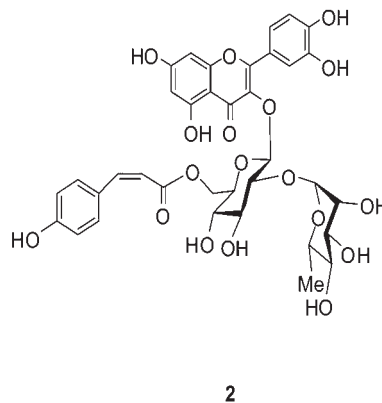
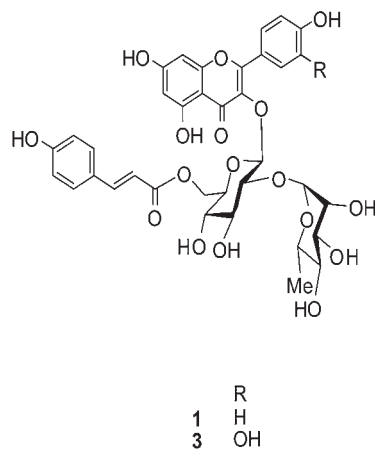

	R ₁	R ₂	R ₃
4	H	H	H
5	H	rha	H
6	H	H	rha
7	OH	rha	H
8	OH	H	rha
9	H	rha	rha
10	OH	rha	rha
11	OH	rha	galloyl

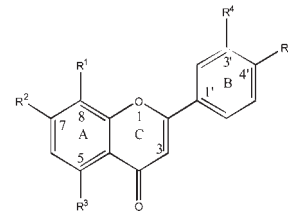

Acknowledgements: This work was supported, in part, by the United States Department of Agriculture, Agricultural Research Specific Cooperative Agreement No.58-6408-2-00009. **References:** [1] Walle UK, Walle T, (2007) *Drug Metab. Dispos.*, 35: 1985–1989.

P-33

Flavonol Glycosides from the Flowering Plant *Gaura biennis*

Xu WH^{1,2}, Jacob MR¹, Agarwal A¹, Liang ZS², Li XC¹, Clark AM¹¹ National Center for Natural Products Research, Research Institute of Pharmaceutical Sciences, School of Pharmacy, The University of Mississippi, University, Mississippi 38677, USA² College of Life Science, Northwest A & F University, Yangling, Shaanxi 712100, China

Phytochemical investigation of the whole plant of *Gaura biennis* led to isolation of eleven flavonol glycosides (1–11). Three of them (1–3) are new compounds and their structures were determined as quercetin 3-O-(2-O- α -rhamnopyranosyl-6-O-E-p-coumaroyl)- β -glucopyranoside (**1**), quercetin 3-O-(2-O- α -rhamnopyranosyl-6-O-Z-p-coumaroyl)- β -glucopyranoside (**2**), and kaempferol 3-O-(2-O- α -rhamnopyranosyl-6-O-E-p-coumaroyl)- β -glucopyranoside (**3**) by spectroscopic interpretations. The known compounds were kaempferol 3-O-glucopyranoside (**4**), kaempferol 3-O-(2-O- α -rhamnopyranosyl)- β -glucopyranoside (**5**), kaempferol 3-O-rutinoside (**6**), quercetin 3-neohesperidoside (**7**), quercetin 3-rutinoside

(8), kaempferol 3-O-(2,6-di-O-rhamnosyl)-glucoside (9), quercetin 3-O-(2,6-di-O-rhamnopyranosyl)-glucopyranoside (10), and quercetin 3-O-(2-O- α -rhamnopyranosyl-6-O-galloyl)- β -glucopyranoside (11). **Acknowledgments:** The authors thank Dr. Bharathi Avula for recording HRESIMS spectra, Mr. Frank T. Wiggers for the assistance in obtaining NMR spectra, Mr. John Hester for repository management, and Dr. Wei Wang and Dr. Yanhong Wang for instrument assistance. This work was supported by the NIH, NIAID, Division of AIDS, Grant No. AI 27094, the USDA Agricultural Research Service Specific Cooperative Agreement No. 58-6408-2-0009, and China Scholarship Council. **References:** [1] Averett TE, et al. (1982) *Phytochemistry*, 21: 1834. [2] Averett TE, Raven PH, (1983) *Phytochemistry*, 22: 1679–1680. [3] Averett TE, Raven PH (1983) *Phytochemistry*, 22: 1680–1681. [4] Hilsenbeck RA, et al. (1984) *Phytochemistry*, 23: 1077–1079. [5] Howard GZ, et al. (1972) *Phytochemistry*, 11: 289–291.

P-34

Flavonoid Glycosides from *Sutherlandia frutescens*

Fu X¹, Li XC², Avula B², Smillie TJ², Mabusele W³, Syce J³, Johnson Q³, Folk W⁴, Khan IA^{1,2}

¹ Department of Pharmacognosy,

² National Center for Natural Products Research, University of Mississippi, MS 38677, USA

³ South African Herbal Sciences and Medicines Institute, University of the Western Cape, Bellville 7535, South Africa

⁴ School of Medicine, University of Missouri-Columbia, Columbia, MO 65211-7020, USA

Sutherlandia frutescens (L.) R. Br (Fabaceae) is a well-known multi-purpose medicinal plant in South Africa that has been widely used as a dietary supplement. Our previous paper has reported the isolation and structure elucidation of four novel cycloartane glycosides from its leaves [1]. Our continuing studies on this medicinally important plant led to the isolation of four new 3-hydroxy-3-methylglutaroyl-containing flavonol glycosides, sutherlandins A–D. Their structures were elucidated by chemical and spectroscopic methods as quercetin 3-O- β -D-xylopyranosyl(1 \rightarrow 2)-[6-O-(3-hydroxy-3-methylglutaroyl)]- β -D-glucopyranoside (1), quercetin 3-O- β -D-apiofuranosyl(1 \rightarrow 2)-[6-O-(3-hydroxy-3-methylglutaroyl)]- β -D-glucopyranoside (2), kaempferol 3-O- β -D-xylopyranosyl(1 \rightarrow 2)-[6-O-(3-hydroxy-3-methylglutaroyl)]- β -D-glucopyranoside (3), kaempferol 3-O- β -D-apiofuranosyl(1 \rightarrow 2)-[6-O-(3-hydroxy-3-methylglutaroyl)]- β -D-glucopyranoside (4). These compounds, along with the previously isolated triterpene glycosides, have been served as chemical markers for commercial products derived from *S. frutescens*.

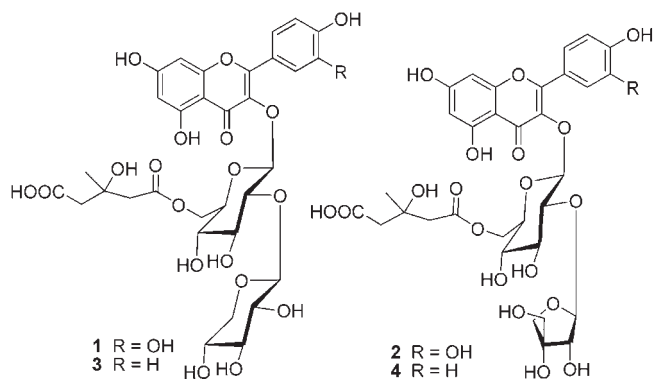

Acknowledgments: The authors thank Mr. Frank T. Wiggers for the assistance in obtaining NMR spectra, and Dr. Charles L. Cantrell for the assistance in GC analysis. This work is supported in part by “The International Center for Indigenous Phytotherapy Studies” funded by NCCAM, grant number 5 U19 AT 003264 and the USDA Agricultural Research Service Specific Cooperative Agreement No. 58-6408-2-0009. **References:** [1] Fu X, et al. (2008) *J Nat Prod*, 71: 1749–53.

P-35

Clerodane and Ent-kaurane Diterpenoids and C13 Nor-isoprenoids from *Casearia sylvestris*

Wang W¹, Ali Z¹, Li XC¹, Khan IA^{1,2}

¹ National Center for Natural Products Research, Research Institute of Pharmaceutical Sciences, and

² Department of Pharmacognosy, School of Pharmacy, The University of Mississippi, MS 38677, USA

Casearia sylvestris (Flacourtiaceae) is a Brazilian and Paraguayan folk medicinal plant called as “Guaçatonga” or “Chá de Bugre” and used to treat snakebite, trauma, ulceration, obesity, and cough [1–5]. As a part of our continued work, thirteen new compounds including five new clerodane diterpene glycosides caseariasides A–E (1–5), three new ent-kaurane diterpene glycosides sylvestrisides C–E (6–8), two clerodane diterpenes caseatrin A–B (9–10), one new nitrogen-containing clerodane diterpenoid caseatrin C (11) and two new C13 nor-isoprenoid glycosides (6S 9S)-blumenyl B 9-O- β -D-glucopyranoside (12) and (6S 9S)-blumenyl B 9-O- β -D-apiofuranosyl-(1 \rightarrow 6)- β -D-glucopyranoside (13) together with eight known compounds, namely, echinophyllin A (14), 4-(2-hydroxyethyl)phenol, blumenol B, icaraside B5, blumenol C, byzantionoside B, loliolide and isoquercitrin were isolated from the leaves of *Casearia sylvestris*. Their structures were determined on the basis of 1 and 2-D spectroscopic analyses. **Acknowledgments:** This work is supported by the United States Department of Agriculture Specific Cooperative Research Agreement Number 58-6408-6-067 and the FDA/CFSAN grant entitled “Science Based Authentication of Dietary Supplements” Number 2 U01 FD 002071-07. **References:** [1] Cruz GL, (1995), *Dicionario Das Plantas Uteis Do Brasil*, 5th ed., Bertrand. p. 599. [2] Lorenzi, Matos FJA, (2002), *Plantas medicinais do Brasil: nativas e exóticas*. Instituto Plantarum, São Paulo, 220–221. [3] Borges MH, et al. (2001), *Toxicol*, 39: 1863–1869. [4] Ruppert BM, et al. (1991), *Mem. Inst. Oswaldo Cruz*, 87(2): 203–205. [5] Sertié JAA, et al. (2000), *Pharmaceut. Biol.*, 38: 112–119.

P-36

Scuteflorins A and B, Dihydropyranocoumarins from *Scutellaria lateriflora* L.

Li J¹, Ding Y², Li XC², Ferreira D¹, Khan IA^{1,2}

¹ Department of Pharmacognosy, School of Pharmacy, The University of Mississippi, MS 38677, USA

² National Centers for Natural Products Research, School of Pharmacy, The University of Mississippi, MS 38677, USA

Scutellaria lateriflora L. (skullcap) is native to North America, but now widely cultivated in Europe and other areas of the world. It has been used for over two hundred years as an effective therapy for anxiety, nervous tension, and convulsions [1]. In America, skullcap is regulated as a dietary supplement and has been classified as an “Herb of Undefined Safety” by the FDA. Despite its extensive use, little data exist regarding the chemical constituents of *Scutellaria lateriflora*. In order to provide the scientific support for the uses of this plant, a systematical chemical study has been conducted. Two new dihydropyranocoumarins, named scuteflorins A and B, together with the known compounds, decursin, chrysin, oroxylin A, wogonin, 5,7-dihydroxy-2',8'-dimethoxyflavone, dihydrochrysin, dihydrooroxylin A, lupenol, 3 α ,24-dihydroxy-olean-12-en-28-oic acid, 3 β ,19 α -dihydroxy-urs-12-en-28-oic acid, ursolic acid, β -sitosterol, daucosterol, palmitic acid, a mixture of arachidic acid, benenic acid and lignoceric acid in a ratio of 2 : 1 : 0.3, and a mixture of 1-triacontanol and 1-dotriacontanol in a ratio of 2 : 1, were isolated from the aerial parts of this plant. Their structures were established by means of extensive 1D and 2D NMR spectra as well as HRMS data. The absolute configuration of dihydropyranocoumarins was determined by a comparison of the experimental and theoretical CD spectra. All the compounds except for wogonin and chrysin are reported for the first time from this plant. **Acknowledgement:** This work is funded in part by the Food Drug Administration contract “Botanical Dietary Supplement: Science-Base for Authentication” FD-U-002071-07. Authors are thankful to Dr. Vaishali Joshi for the authentication of plant material. **References:** [1] Foster S, (1996), *The Business of Herbs*, May/June, p. 14–16.

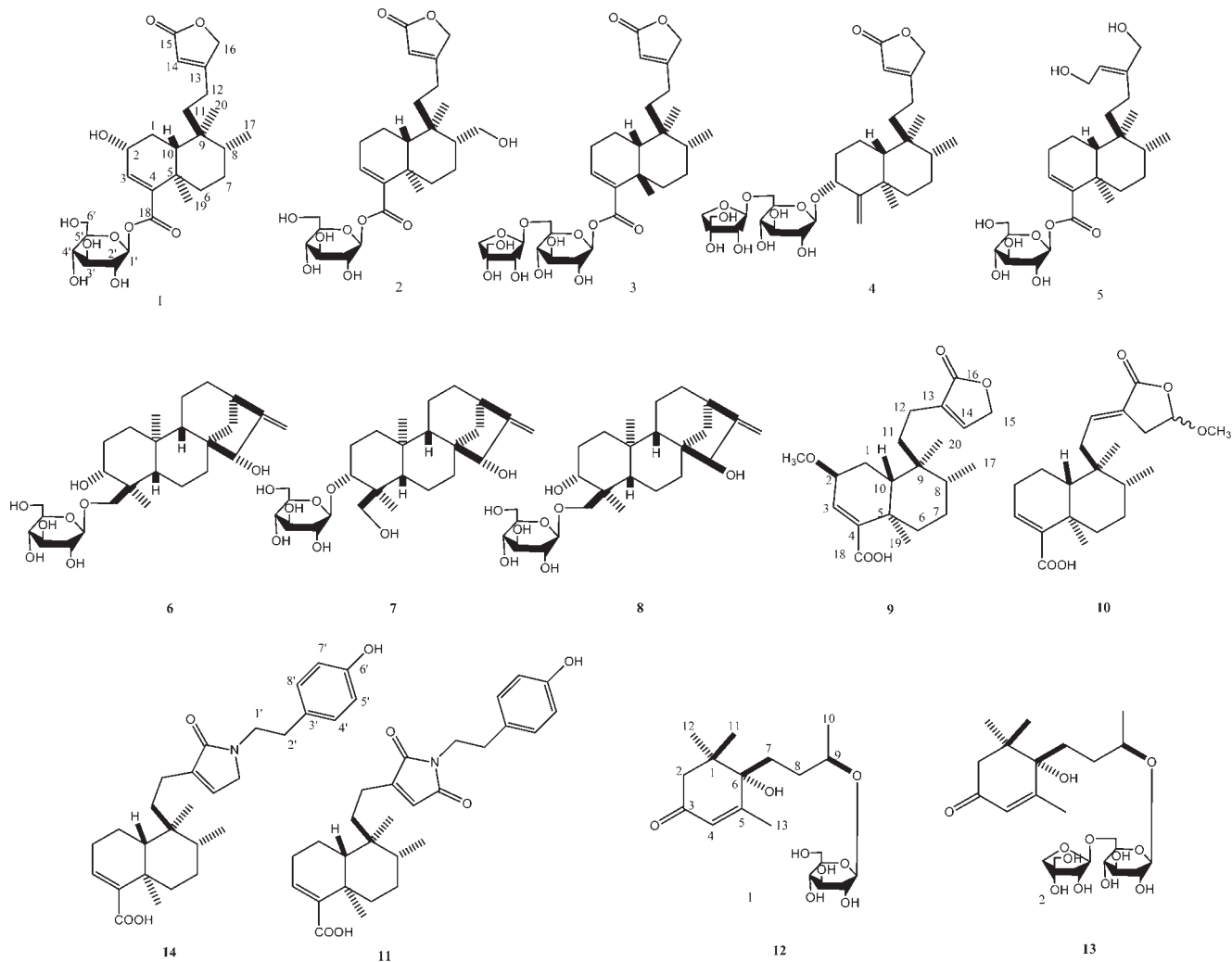

P-37

New Terpenoids from *Pfaffia paniculata* Kuntze

Li J¹, Jadhav AN², Rumalla CS², Khan IA^{1,2}

¹ Department of Pharmacognosy, School of Pharmacy, The University of Mississippi, MS 38677, USA

² National Center for Natural Products Research, School of Pharmacy, The University of Mississippi, MS 38677, USA

Pfaffia (Amaranthaceae) has around ninety species in Central and South America, of which *Pfaffia paniculata* Kuntze (commonly called suma), is the most employed species in commercial preparations in Brazil as “Brazilian ginseng” and has been commonly used for three centuries for the same indications as American and Asian ginseng [1,2]. It is also known as “Para Toda” which means “for all things” since the root of this plant has been used by native Brazilians as a tonic, aphrodisiac, and as a remedy for many types of illnesses, such as diabetes, ulcers, cancer etc [3]. Phytosterols (mainly β -ecdysone), pfaffic acid (hexacyclic nortriterpene) and their glycosides, named pfaffosides A–F (saponins), have been reported from *P. paniculata* [4–7]. The saponins have demonstrated the ability to inhibit the growth of cultured tumor cell melanomas in vitro [6,7]. These saponins and pfaffic acid derivatives were patented as anti-tumor compounds in several Japanese patents in the mid-1980s [9,10]. In the present study, a detailed phytochemical investigation of *P. paniculata* was carried out. Two new nortriterpenoids pfaffine A and B, one monoterpene glycoside pfaffine C, along with the known compounds, ecdysone, 20-hydroxyecdysone, pterosterone, rapisterone, pfaffic acid, pfaferic acid, mesembryanthemoidigenic acid, Calendulose E 6'-methyl ester, oleanolic acid 28-O- β -D-glucopyranoside were isolated from the roots of this plant. Their structures were determined through the extensive analysis of 1D- (¹H, ¹³C, DEPT) and 2D-NMR (COSY, HSQC, HMBC, NOESY) spectra, as

well as chemical methods. **Acknowledgement:** This work is funded in part by the Food Drug Administration contract “Botanical Dietary Supplement: Science-Base for Authentication” FD-U-002071-07. Authors are thankful to Dr. Vaishali Joshi for the authentication of plant material. **References:** [1] Vasconcelos JMO (1982), Estudo taxonomico sobre Amaranthaceae no RS, Brasil. Porto Alegre, 151 p. [2] Taniguchi SF, et al. (1997), *Phytother. Res.*, 11: 568–571. [3] Oliveira F, (1986), *Revista Brasileira de Farmacognosia*, 1: 86–92. [4] Wakunaga Pharmaceutical Co., Ltd., Japan (1984), *Jpn. Kokai Tokkyo Koho.*, 5 pp. [5] Takemoto T, et al. (1983), *Tetrahedron Letters*, 24, 1057–60. [6] Nishimoto N, et al. (1984), *Phytochemistry*, 23: 139–42. [7] Nakai S, et al. (1984), *Phytochemistry* 23: 1703–1705. [8] Oshima M, Gu Y, (2003), *Journal of Reproduction and Development*, 49: 175–180. [9] Takemoto T, Odajima T, (1984), *Jpn. Kokai Tokkyo Koho.*, 7 pp. [10] Takemoto T, Odajima T, (1984), *Jpn. Kokai Tokkyo Koho.*, 11 pp.

P-38

Application of NMR-Based Metabolomics in Assessment of Botanicals

Zhao JP¹, Avula B¹, Wang YH¹, Joshi VC¹, Smillie TJ¹, Khan IA^{1,2}

¹ National Center for Natural Products Research,

² Department of Pharmacognosy, School of Pharmacy, University of Mississippi, University, MS 38677, USA

Metabolomics is increasingly being used in a broad range of sciences including systems biology, drug discovery, molecular and cell biology and other medical and agricultural sciences [1,2]. The metabolomic analyses of *Hoodia* (*Hoodia gordonii*), *Maca* (*Lepidium meyenii* Walp.) and *Ginkgo* (*Ginkgo biloba*), as well as their products, were performed using ¹H-NMR spectroscopy and multivariate statistical analysis. The different extraction conditions for sam-

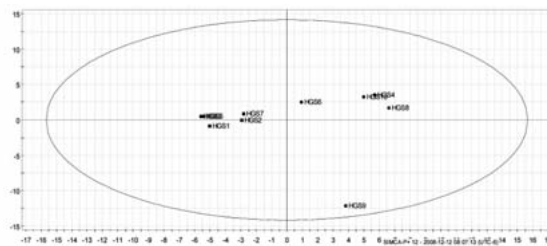
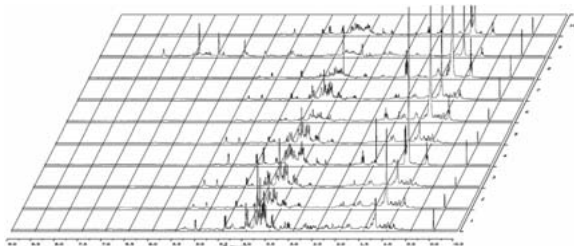

ple preparation were investigated. This study demonstrated that the NMR-based metabolomics is a useful tool for the characterization, classification and authentication of botanicals. **Acknowledgements:** This work was funded by the FDA/CFSAN grant entitled "Science Based Authentication of Dietary Supplements" Number 2 U01 FD 002071-07. **References:** [1] Lindon JC, et al. (2006), *Pharm Res*, 23(6): 1075–1088. [2] Hollywood K, et al. (2006), *Proteomics*, 6: 4716–4723.

P-39

Constituents from Sarcotestas of Ginkgo Fruits

Zhao JP¹, Sun LZ³, ElSohly MA¹, Avery MA³, Khan IA^{1,2}

¹ National Center for Natural Products Research,

² Department of Pharmacognosy, School of Pharmacy, University of Mississippi, University, MS 38677, USA

³ Department of Medicinal Chemistry, School of Pharmacy, University of Mississippi, University, MS 38677, USA

Ginkgo tree (*Ginkgo biloba*, Family: Ginkgoaceae) is called as a living fossil, as one of the oldest trees still living on earth. The tree has a high economic value. Numerous ginkgo plantations have been developed over the world because of the increasing demand of ginkgo leaves [1]. Unlike the leaves, the fruits of ginkgo have not been well utilized. A ginkgo fruit consists of a soft and fleshy section (the sarcotesta), and a hard section (the sclerotesta). Previous pharmacological studies have reported that the extract of sarcotestas has various bioactivities including antibacterial, anti-tumor, pesticidal, mutagenic, allergenic, anti-HIV and immunomodulatory properties [2,3]. In the present study, a phytochemical investigation of the constituents of sarcotestas of ginkgo fruits led to isolation and identification of twenty three compounds. Four of them were new (compounds 1–4). The structures of compounds 1–3 are unusual and have not been reported in nature yet. Their structures were elucidated by using spectroscopic, spectrometric and chemical methods. The biosynthesis pathways of compounds 1–3 are also proposed. **Acknowledgements:** The authors would like to thank Dr. Bharathi Avula for recording the mass spectrometric data. This work was funded by the FDA/CFSAN grant entitled "Science Based Authentication of Dietary Supplements" Number 2 U01 FD 002071-07. **References:** [1] van Beek, T. A. (2000) *Ginkgo biloba*. Harwood Academic, Australia. [2] Duan, R. (2002) *Shipin Yu Fajiao Gongye*, 28 (8), 57–61. [3] Jaggy, H.; Koch, E. (1997) *Pharmazie*, 52(10), 735–738.

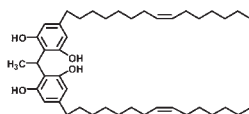

1

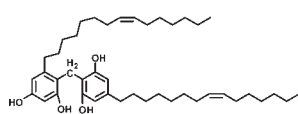

2

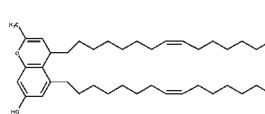

3

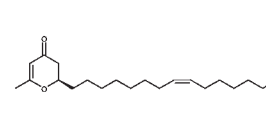

4

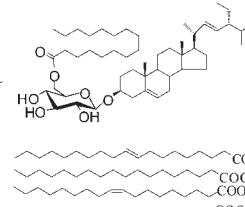
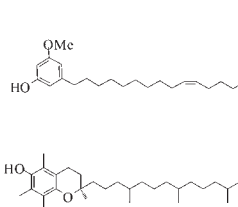
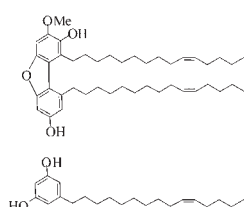
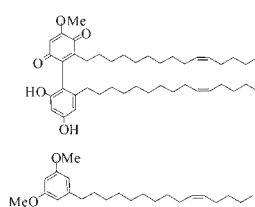

COOH
COOH
COOH
COOH

P-40

Chemical Constituents of *Labisia pumila* (Kacip Fatimah)

Ali Z¹, Khan IA^{1,2}

¹ National Center for Natural Products Research and

² Department of Pharmacognosy, Research Institute of Pharmaceutical Sciences, School of Pharmacy, University of Mississippi, MS 38677, USA

Labisia pumila (Blume) Fern.-Vill., a short herbaceous plant belongs to a small genus of the Myrsinaceae family. It grows widely throughout the Malaysian rain forest and is locally known as Kacip Fatimah. The traditional practitioners have used *L. pumila* to maintain a healthy female reproductive system, to cure delayed fertility and to regain body strength. Kacip Fatimah is also used to reduce excessive gas, treat flatulence, dysentery, dysmenorrhea, gonorrhea and bone sickness [1]. The extract of the plant is also used as a drink to gain energy. There is a remarkable boom in the market for Kacip Fatimah, unfortunately there is no scientific report on its chemical constituents to support these claims. In this study we explored the chemistry of *L. pumila* for the first time. A multi-class of natural products belonging to phenolic compounds containing long chains, glycerogalactolipid, cerebrosides, alpha-tocopherol, sterols and lipids were isolated from the methanolic extract of *L. pumila*. Their structures were determined by chemical and extensive spectroscopic methods including NMR and HRESIMS techniques. **Acknowledgement:** The work was supported by the United States Food and Drug Administration (FDA) Specific Cooperative Agreement No. U01 FD 002071-07. **References:** [1] Effendy AWM, et al. (2006), *Journal of Sustainability Science and Management*, 1: 40–46.

P-41

Chemical Constituents of *Terminalia chebula*

Ali Z¹, Khan IA^{1,2}

¹ National Center for Natural Products Research and

² Department of Pharmacognosy, Research Institute of Pharmaceutical Sciences, School of Pharmacy, University of Mississippi, MS 38677, USA

Terminalia chebula Retz., a flowering evergreen tree belongs to the genus *Terminalia* of the Combretaceae family. Its fruit has been traditionally used for household remedy for human ailments. *T. chebul-*

la has been extensively used in Ayurveda, Unani and homeopathic medicine. Though it is a rich source of tannins and other phenolic compounds, some triterpenes and/or their glycosides were also reported from *T. chebula* [1]. For further phytochemical discoveries we investigated this plant and isolated olanolic acid-derived triterpenes. These structures were determined by spectroscopic methods including NMR and HRESIMS techniques.

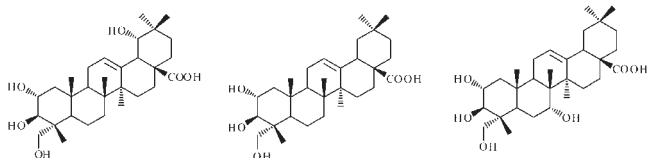

Acknowledgement: The work was supported by the United States Food and Drug Administration (FDA) Specific Cooperative Agreement No. U01 FD 002071-07. **References:** [1] Chattopadhyay RR, Battacharyya SK, (2007), *Pharmacognosy Reviews*, 1: 151–156.

P-42

Chemical Constituents from *Centella erecta* (L. f.) Fern.

Rumalla CS¹, Ali Z¹, Avula B¹, Weerasooriya AD¹, Smillie TJ¹, Khan IA^{1,2}

¹ National Center for Natural Products Research, Research Institute of Pharmaceutical Sciences,

² Department of Pharmacognosy, School of Pharmacy, The University of Mississippi, MS 38677, USA

Centella or Indian Pennywort, *Centella asiatica* (L.) Urb. belongs to the family Apiaceae. It has been widely cultivated in China, South-east Asia, India, Sri Lanka and Africa as green vegetable and medicinal herb. It is valued in Indian system of medicine for improving memory and for the treatment of nerve disorders and skin diseases. The plant and its extract were incorporated into the Indian Pharmacopeia for the treatment of inflammation and epidermal wound healing. *C. asiatica* is becoming a popular ingredient in various herbal products. However, *Centella erecta* (L. f.) Fern. is very closely related species to *C. asiatica* that is commonly found in the southern US and is easily confused with each other. Although *C. asiatica* has been thoroughly investigated, no compressive chemical studies were done on *C. erecta* [1,2]. A new triterpene (2 α ,3 β , 4 α)-23-(sulphonyl)-2,3-dihydroxyurs-12-en-28-oic acid *O*- α -L-rhamnopyranosyl-(1 \rightarrow 4)-*O*- β -D-glucopyranosyl-(1 \rightarrow 6)- β -D-glucopyranosyl ester (1) together with eleven known compounds including asiatic acid (2), madecassic acid (3), asiaticoside (4), mdecassoside (5), (2 α ,3 β , 6 β)-trihydroxyolean-12-en-28-oic acid *O*- α -L-rhamnopyranosyl-(1 \rightarrow 4)-*O*- β -D-glucopyranosyl-(1 \rightarrow 6)- β -D-glucopyranosyl ester (6), Betulabuside A (7), 3-oxo- α -ionyl-9-*O*- β -D-glucopyranoside (8), vomifoliol-9-*O*- β -D-glucopyranoside (roseoside) (9), 1,8-heptadecadiene-4,6-diyne-3,10-diol (10), (2S)-1-*O*-stearoyl-2-*O*-stearoyl-3-*O*-[α -D-galacto-pyranosyl-(1''6')- β -D-galactopyranosyl] glycerol (11), (2S)-1-*O*-linolenyl-2-*O*-linolenyl-3-*O*-[α -D-galacto-pyranosyl-(1''6')- β -D-galacto pyranosyl]glycerol (12) (Fig. 1) were isolated from the whole plant of *Centella erecta* and their structures were elucidated using ¹H-NMR, ¹³C-NMR, HSQC, HMBC, COSY and HRMS as well as comparison with reported data. **Acknowledge-**

ments: This research is funded in part by The United States Department of Agriculture Specific Cooperative Research Agreement Number 58-6408-6-067 and the FDA/CFSAN grant entitled Science Based Authentication of Dietary Supplements Number 2 U01 FD 002071-07. The Authors would like to thank Dr. Vaishali Joshi for authenticating the plant material. **References:** [1] Mabberley DJ, (1997), *The Plant Book: A portable dictionary of the higher plants*. Cambridge University Press. [2] Shakir JS, et al. *Nat. Prod. Radianc* 6(2): p. 158–170, (2007).

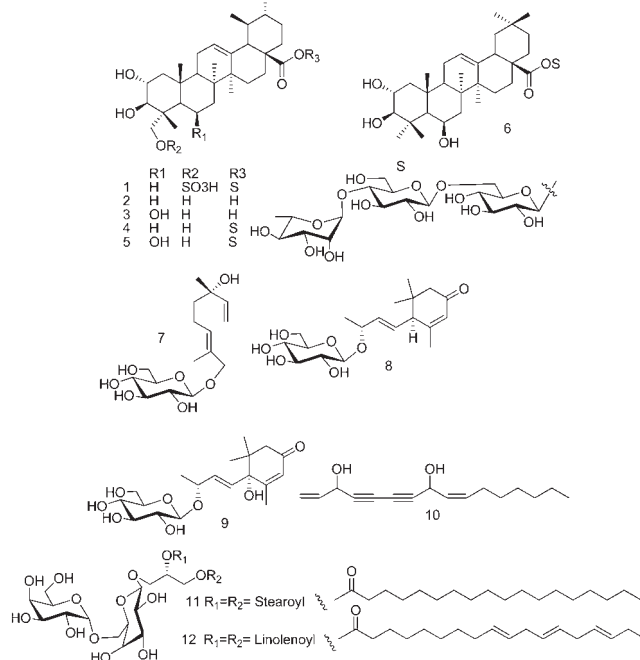

P-43

Chemical Fingerprint Analysis of Two *Centella* Species, Quantification of Triterpenoids and its Glycosides by using HPTLC Method

Rumalla CS¹, Avula B¹, Wang YH¹, Weerasooriya AD¹, Smillie TJ¹, Khan IA^{1,2}

¹ National Center for Natural Products Research, Research Institute of Pharmaceutical Sciences,

² Department of Pharmacognosy, School of Pharmacy, The University of Mississippi, MS 38677, USA

Centella asiatica (L.) Urb. (Family Apiaceae commonly known as Gotu Kola or Indian Pennywort) has long been used in the Ayurvedic system of medicine for improving memory and for the treatment of a variety of ailments [1]. The triterpenoid compounds purportedly represent the chief pharmacologically active constituents. The triterpenoids, especially asiaticoside, triterpine trisaccharide, are reported as the most active compounds in the plant [2]. A simple and fast method was developed for the quantitative determination of four triterpenes and their glycosides i.e. asiatic acid (AA), madecassic acid (MA), asiaticoside (AS) and madecoside (MS) in

Table 1 Validation Parameters.

Parameter	AA	MA	AS	MS
1 Linearity range (ng/spot)	200 – 600	200 – 600	100 – 500	100 – 500
2 Correlation coefficient	0.999	0.998	0.997	0.998
4 LOD (ng/spot)	30	60	30	30
5 LOQ (ng/spot)	180	200	100	100
6 Specificity	Specific	Specific	Specific	Specific
7 Regression equation	Y = 94.580 + 8.961 X	Y = 61.937 + 3.124 X	Y = 22.600 + 0.495 X	Y = 12.773 + 0.113 X
8 Rf	0.72	0.61	0.17	0.11

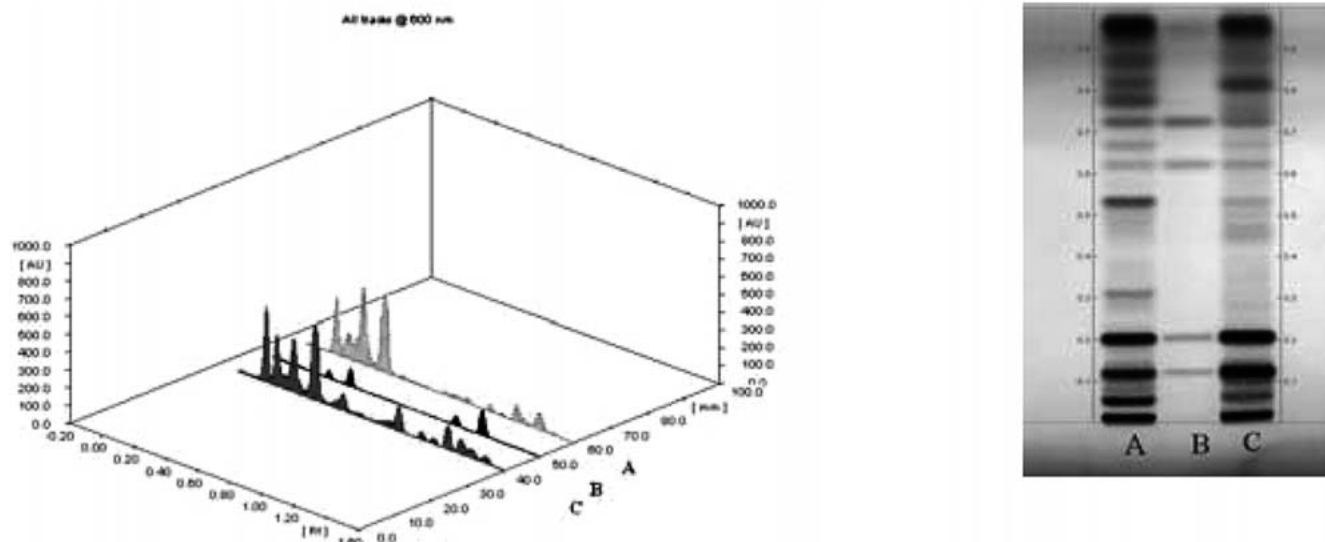

Fig. 1 (A) *Centella asiatica*, (B) Standard mix, (C) *Centella erecta*.

Table 2 Percentage (w/w) of asiatic acid, madecassic acid, asiaticoside, and madecoside in plant sample.

Sample name (Percentage in dry plant material)	AA	MA	AS	MS
<i>C. asiatica</i>	0.2	0.2	3.6	2.0
<i>C. erecta</i>	0.1	0.1	4.5	3.1

Centella asiatica and *Centella erecta* by using high performance thin layer chromatographic method. The separation was achieved with chloroform: methanol: water: 13.0:6.5:0.5 v/v/v on silica gel $^{60}\text{F}_{254}$ HPTLC plates. Quantitation was performed with densitometry in absorption-reflection mode at 600 nm by scanning the HPTLC plates after a color development by anisaldehyde reagent. The linear regression data for the calibration plots showed a good linear relationship with $r = 0.999, 0.998, 0.997$ and 0.998 for asiatic acid, madecassic acid, asiaticoside and madecoside, respectively. The established method was validated in terms of LOD and LOQ, linearity. **Acknowledgements:** This research is funded in part by The United States Department of Agriculture Specific Cooperative Research Agreement Number 58-6408-6-067 and the FDA/CFSAN grant entitled Science Based Authentication of Dietary Supplements Number 2 U01 FD 002071-07 **References:** [1] Shakir JS, et al. (2007), Nat. Prod. Radiance, 6 (2): 158–170. [2] de Paula Reis, et al. (1996), Revista Brasileira de Farmácia, 77(2): 71–72.

P-44

Coumarins and Triterpenoids from *Ludwigia hyssopifolia* L.

Rao AS¹, Ali Z¹, Smillie TJ¹, Khan IA^{1,2}

¹ National Center for Natural Products Research, School of Pharmacy, The University Of Mississippi, University, MS, 38677, USA

² Department of Pharmacognosy, School of Pharmacy, The University of Mississippi, University, MS 38677, USA

Ludwigia hyssopifolia Linn. (Synonym *Jussiaea hyssopifolia* G. Don, *Jussiaea linifolia* Vahl non *Ludwigia linifolia* Poir. Family-Onagraceae; Bengali name – Lalbunlonga) is extensively grown in Bangladesh, India and Ceylon. This plant is considered as an astringent, anthelmintic, carminative and diuretic. A decoction of this plant is used for the treatment of diarrhea, dysentery, flatulence, leucorrhoea, spitting of blood, vermifuge and purgative [1]. The leaves are used in poultices for orchitis and glands in the neck. Previous phytochemical investigation of *Ludwigia hyssopifolia* found piperine

as a potential marker compound in addition to the isolation of vitexin, isovitexin, orientin and isoorientin [2]. As a continuation our dietary supplement work we isolated a series of coumarins and triterpenoids from this plant. Compounds 1–4 are known, but this is the first report of their isolation from this plant.

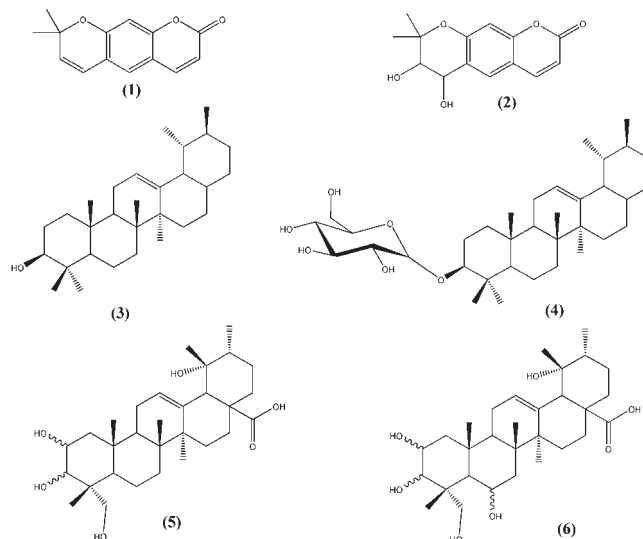

Acknowledgement: The work was supported by the United States Department of Agriculture, Agricultural Research Service Specific Cooperative Agreement Number 58-6408-06-067. Thanks to Mr. Frank Wiggers for NMR and Dr. Barathi Avula for HRESIMS. **References:** [1] Shaphiullah M, et al. (2003), Pak J Pharm Sci, 16(1): 7–11. [2] Das B, et al. (2007) Pak J Pharm Sci, 20(2): 128–31.

P-45

Shikimic Acid as a Marker Compound from *Ludwigia alternifolia* L.

Rao AS¹, Smillie TJ¹, Khan IA^{1,2}

¹ National Center for Natural Products Research, School of Pharmacy, The University Of Mississippi, University, MS, 38677, USA

² Department of Pharmacognosy, School of Pharmacy, The University of Mississippi, University, MS 38677, USA

Ludwigia alternifolia L belongs to the Onagraceae family and is distributed throughout the Northeast, Midwest and Southern US. Shikimic acid (Fig. 1) was first isolated in 1885 by Eijkman from the fruit of the Japanese plant *Illicium religiosum* Sieb [1]. The elucidation

tion of its structure nearly 50 years later [2,3] and the discovery that shikimic acid was found to play an important role in the biosynthesis of the three aromatic amino acids phenylalanine, tyrosine, and tryptophan [4] resulted in an intensified research effort towards its synthesis [5–9], isolation from other organisms [10], identification of its metabolites [11, 12] and its transformation into potential chemotherapeutics. This latter area of research has led to the syntheses of various bioactive compounds from shikimic acid. The research outlined in this presentation is the first report for the isolation of shikimic acid from this plant.

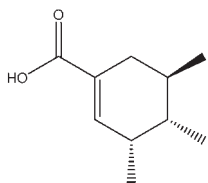

Acknowledgements: The work was supported by the United States Department of Agriculture, Agricultural Research Service Specific Cooperative Agreement Number 58-6408-06-067. Thanks to Mr. Frank Wiggers for NMR, Dr. Barathi Avula for HRESIMS, Dr. Vaishali C Joshi for plant identification at the National Center for Natural Products Research. **References:** [1] Eijkman JF, (1885) Recl Trav Chim 4: 32. [2] Fischer HOL, Dangschat G (1934) Helv Chim Acta 17: 1200. [3] Fischer HOL, Dangschat G. (1935) Helv. Chim. Acta 18: 1204. [4] Davis BDJ (1951) Biol Chem, 191: 315. [5] Campbell MM, et al. (1993) Synthesis 1. [6] Jiang S, Singh G, (1998), Tetrahedron 54: 4697. [7] Shinada T, et al. (1998) Tetrahedron Lett 39: 6027 [8] Mehta G, Mohal N (1998) Tetrahedron Lett 39: 3285 [9] Yoshida N, Ogasawara K (2000) Org. Lett 2: 1461. [10] Hattori S, Yoshida S, Hasegawa M. (1954) Physiol. Plantarum 7: 283 [11] Bohm, BA (1965) Chem. Rev 65: 435 [12] Haslam E. Shikimic Acid Metabolism and Metabolites; John Wiley and Sons: New York, 1993.

P-46

Structure Elucidation and Absolute Configuration of Megastigmane Derivatives from *Cissus quadrangularis* Linn

Rao AS¹, Ali Z¹, Slade D¹, Smillie TJ¹, Khan IA^{1,2}

¹ National Center for Natural Products Research, School of Pharmacy, The University Of Mississippi, University, MS, 38677, USA

² Department of Pharmacognosy, School of Pharmacy, The University of Mississippi, University, MS 38677, USA

Cissus a genus of approximately 350 species of a woody climber (Family: Vitaceae) includes *Cissus quadrangularis* Linn (Veldt grape, winged treebine) which is often used as a medicinal plant. Commonly known as “bone setter”, the plant can be found in the warmer regions of India, Ceylon, East Africa, Malaysia and Thailand [1]. *C. quadrangularis* is used as a common food supplement in southern India, while the stem is traditionally used for the treatment of gastritis, bone fractures, skin infections, constipation, eye diseases, piles, anemia, asthma, irregular menstruation, burns and wounds

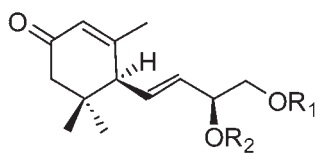

(1)

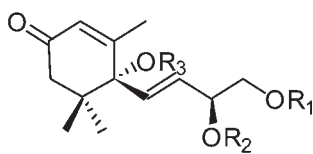
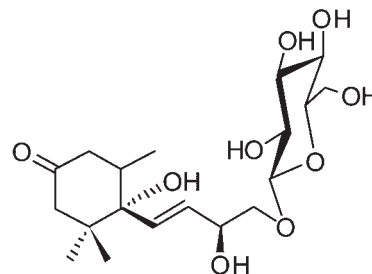
(3) R₁ = H, R₂ = Glucopyranoside, R₃ = H(2) R₁, R₂ = H, R₃ = Glucopyranoside

(4)

[2,3]. The fresh stem and leaves of *C. quadrangularis* is used for the treatment of hemorrhoids, menstrual disorders, scurvy and flatulence [4–8]. Phytochemical analysis of *C. quadrangularis* resulted in the identification of several classes of compounds e.g., flavonoids, triterpenoids and stilbene derivatives. As part of our continuing program to identify chemical and/or biomarkers of dietary supplements, we isolated four new megastigmane derivatives (1–4), and thirteen known compounds (5–17), trans-3-Oxo-ionol (5), corchoinoside C (6), resveratrol (7), pallidol (8), quadrangularin A (9), quadrangularin B (10), quadrangularin C (11), parthenocissin A (12), quercetin 3-O- α -L-rhamnoside (13), quercetin 3-O- β -D-glucopyranoside (14), isoengelitin (15), (+)-isolariciresinol 3-O- β -D-glucopyranoside (16) and avaculin (17) from *Cissus quadrangularis* Linn. **Acknowledgements:** The work was supported by the United States Department of Agriculture, Agricultural Research Service Specific Cooperative Agreement Number 58-6408-06-067. Thanks to Mr. Frank Wiggers for NMR work, Dr. Barathi Avula for HRESIMS and Dr. Vaishali C Joshi for plant identification at the National Center for Natural Products Research. **References:** [1] Pongboonrod S, (1995), Printing Thailand, 428–9. [2] Asolkar LV, et al. (1992), CSIR Publication, New Delhi 61. [3] Kritikar KR, Basu BD, (2000), Allahabad India, 841–843. [4] Udupa KN, Prasad G, (1964), Indian J Med Res. 52: 480–487 [5] Udupa KN, Prasad GC, (1964), Indian J Med Res. 52: 26–35 [6] Udupa KN, Prasad G, (1963) Indian J Med Res. 51: 667–676. [7] Singh LM, Udupa KN, (1962) Indian J Med Sci. 16: 926–931 [8] Udupa KN, et al. (1961) Indian J Med Sci. 15: 551–557

P-47

Synthesis of Psoralens

Rao AS¹, Smillie TJ¹, Khan IA^{1,2}

¹ National Center for Natural Products Research, School of Pharmacy, The University Of Mississippi, University, MS, 38677, USA

² Department of Pharmacognosy, School of Pharmacy, The University of Mississippi, University, MS 38677, USA

Psoralens, also known as furanocoumarins and coumarine derivatives, are naturally occurring or synthetic tricyclic aromatic compounds. They reveal interesting photobiological activities such as skin photosensitization, characterized by the onset of erythema followed by dark pigmentation. The related angular isomers, namely angelicin, are also present in plants and have been chemically synthesized [1]. Psoralens are also of interest because they are used as a probe in molecular biology and nucleic acid chemistry [2]. Coumarins can be classified in the latter group [3]. In this paper we discuss the synthesis of psoralens (Scheme I and II). Currently there is only one report of antifungal activity reported for angular coumarins [4–5]. As part of our ongoing research program to identify chemical and/or biomarkers of dietary supplements we have synthesized a series of psoralens for biological evolution.

Scheme I

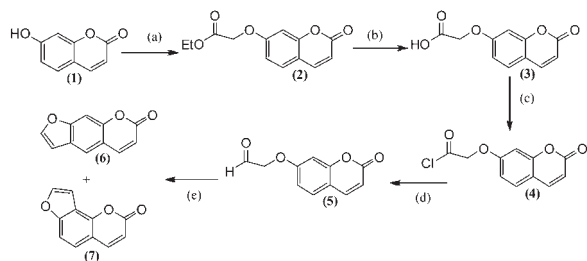

Scheme II

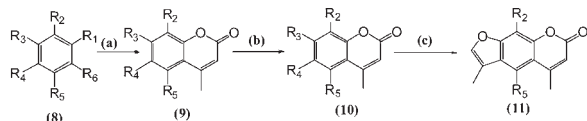

Acknowledgements: The work was supported by the United States Department of Agriculture, Agricultural Research Service Specific Cooperative Agreement Number 58-6408-06-067. Thanks to Dr. Barathi Avula for HRESIMS and Dr. Vaishali C Joshi for plant identification at the National Center for Natural Products Research. **References:** [1] Wulff WD, et al. (1988), *J Am Chem Soc.* 110: 7419–34. [2] Cimino GD, et al. (1985) *Ann Rev Biochem* 54: 1511–93. [3] Moor ACE, Gasparro FP, (1996) *Clin Dermatol*, 14: 353–365. [4] Grayer RJ, Harborne JB, (1994) *Phytochemistry*, 37: 19. [5] Chimichi S, et al. (2002) *Tetrahedron* 58: 4859–4863.

P-48

Indolizidine, Antiinfective and Antiparasitic Compounds from *Prosopis glandulosa* Torr. *Var. glandulosa*

Samoylenko V¹, Ashfaq MK¹, Jacob MR¹, Tekwani BL^{1,2}, Khan SI¹, Manly SP¹, Joshi VC¹, Walker LA^{1,2}, Muhammad I¹
¹ National Center for Natural Products Research and
² Department of Pharmacology, Research Institute of Pharmaceutical Sciences, School of Pharmacy, The University of Mississippi, University, Mississippi 38677, USA

A new potent antiinfective and antiparasitic 2,3-dihydro-1H-indolizinium chloride, (1), was isolated from *Prosopis glandulosa* Torr. *var. glandulosa*. Three additional new (2–4) and one known (5) indolizidines were also isolated, and the dihydrochloride salts of 1–3 (compounds 6, 7 and 8) were prepared. The structures were determined by 1D and 2D NMR and mass spectra. Compound 1 showed potent *in vitro* antifungal and antibacterial activities against *Cryptococcus neoformans*, *Aspergillus fumigatus*, methicillin-resistant *Staphylococcus aureus* and *Mycobacterium intracellulare*. The remarkable fungicidal activity of 1–4 against *C. neoformans* and 2, 3, and 5 against *A. fumigatus* were similar to amphotericin B, but >2–4-fold more potent than 6–8. Prosopilosidine (1) showed potent *in vivo* activity at 0.0625 mg/Kg/day/ip for 5 days in a murine model of cryptococcosis by eliminating ~76% of *C. neoformans* infection from brain tissue compared to ~83% with amphotericin B at 1.5 mg/Kg/day. Compounds 1 and 4 exhibited potent activity against chloroquine sensitive (D6) and chloroquine resistant (W2) strains of *Plasmodium falciparum*. Prosopilosine (1) also showed *in vivo* antimalarial activity with an ED₅₀ value of ~2 mg/Kg/day/ip against *Plasmodium berghei*-infected mice after 3 days of treatment.

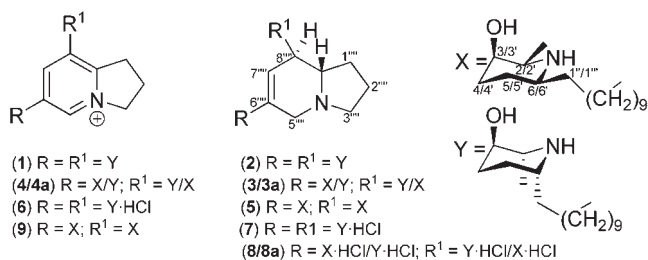

Acknowledgements: The authors sincerely thank Dr. Alice M. Clark, Vice-Chancellor for Research and sponsored programs, UM, for her valuable advise on antifungal activity of compounds, and Dr. Troy Smillie, Dr. D. Chuck Dunbar, Ms. Sharon Sanders, Mr. John Trott, Ms. Marsha Wright, Dr. Anupam Pradhan, Ms. Lavanya Madgula and Mr. Mohammed A. Hammad, NCNPR, for plant acquisition and biological work. This work was supported in part by the USDA-ARS Specific Cooperative Agreement No. 58-6408-2-0009, NIH, NIAID, Division of AIDS, Grant No. AI 27094, and MMV Grant No. 06-2026.

P-49

Lanostane-Type Triterpenes from the Mushroom *Astraeus pteridis* with Antituberculosis Activity

Ross SA^{1,2}, Stanikunaite R², Radwan MM¹, Trappe JM³, Fronczek F⁴

¹ National Center for Natural Products Research, School of Pharmacy, The University of Mississippi, University, Mississippi 38677

² Department of Pharmacognosy, School of Pharmacy, The University of Mississippi, University, Mississippi 38677

³ Department of Forest Ecosystems and Society, Oregon State University, Corvallis, Oregon 97331-5752

⁴ Department of Chemistry, Louisiana State University, Baton Rouge, Louisiana 70803-1804

Astraeus pteridis (Shear) Zeller, which mimics a truffle in its early developmental stage, is an earth-star fungus in the *Astraeaceae*, (Phylum Basidiomycota, Order Boletales). It is known only from western North America, occurring alone or in groups on the ground in forests of conifers, with which it forms symbiotic, mycorrhizal associations [1]. It is unpalatable because of its leathery texture and powdery spore mass. The related *Astraeus hygrometricus* (Pers.) Morgan has been used traditionally in Chinese folk medicine as a hemostatic agent [2]. Several triterpenoids have been isolated from *A. hygrometricus*, but no biological activities have been investigated [3]. Bioassay-guided fractionation of the EtOH extract of the Truffle-mimicking mushroom *Astraeus pteridis* led to the isolation and identification of three new (3–5) and two known (1, 2) lanostane triterpenes, and phenylalanine betaine. The structures of the isolates were elucidated based on 1D and 2D NMR spectroscopic data, HRESIMS results, and X-ray crystallographic analysis. The antituberculosis activity of the isolates was evaluated. Compounds 5 and 1 showed moderate antituberculosis activity with MIC values of 34.0 and 58.0 µg/mL, respectively.

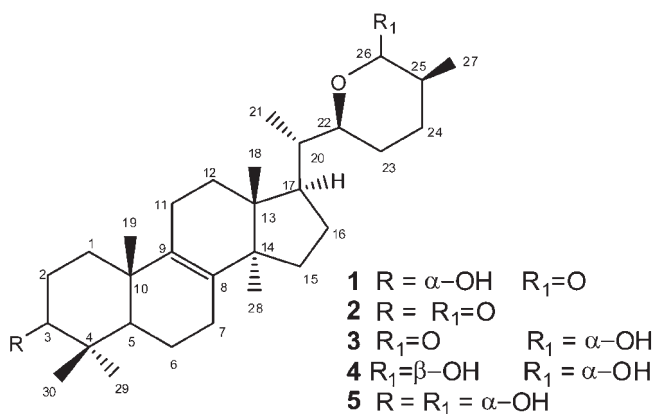

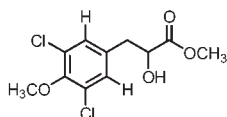

1

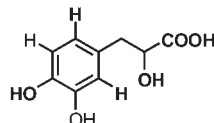

2

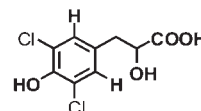

3

Acknowledgements: We are grateful to the University of Illinois at Chicago for the antituberculosis and cytotoxicity assays and to A. Beyerle of the North American Truffling Society for the collection of specimens. **References:** [1] Molina A, Trappe, (1982), *J Forest Sci*, 28: 423–458. [2] Ying J, et al. (1987), *Icones of medicinal fungi from China*. Science Press, Beijing, China. [3] Takaishi Y, et al. (1987), *Phytochemistry*, 26: 2341–2344.

P-50

Chemical Constituents of *Postia balsamea*

Kumarihamy M^{1,2}, Nanayakkara NPD², Ferreira D^{1,2}

¹ Department of Pharmacognosy,

² National Center for Natural Products Research, Research Institute of Pharmaceutical Sciences, School of Pharmacy, University of Mississippi, University, MS 38677

Postia balsamea (Aphylophorales, Basidiomycota) is the causal agent of root rot and butt rot in balsam fir (*Abies balsamea* family Pinaceae). Mechanical or insect caused wounds to the roots or basal areas of trees provide entrances for the fungi. Root rot and butt rot cause considerable losses in softwood production [1]. Our previous studies reported the presence of polyacetylene compounds having phytotoxic activity from *Postia balsamea* [2]. We report herein on the isolation and characterization of new phenolic compounds methyl 3-(3,5-dichloro-4-methoxyphenyl)-2-hydroxypropanoate (1), 3-(3,4-dihydroxyphenyl)-2-hydroxypropanoic acid (2), 3-(3,5-dichloro-4-hydroxyphenyl)-2-hydroxypropanoic acid (3) along with two known lanostane-type triterpenes, acetyl eburicoic acid and eburicoic acid from the ethyl acetate extract of the fermentation broth of *Postia balsamea*. These two triterpenes have previously been isolated [3,4] and found to inhibit the proliferation of human HL-60 myeloid leukemia cells in a dose dependant manner [4]. **Acknowledgements:** Dr. Bharathi Avula, National Center for Natural Products Research, for providing the high resolution Mass spectral data. **References:** [1] Rizzo DM, Harrington TC, (1988) *Plant diseases*, 72: 329–331. [2] Kumarihamy M, et al. (2008), *Planta Medica*, 74: 351. [3] Tai T, et al. (1993), *Phytochemistry*, 32: 1239–1244. [4] Leon F, et al. (2004), *J Nat Prod*, 67, 2008–2011.

P-51

Biosynthesis of Salvinatorin A: Overexpression and Biochemical Characterization of Carboxy Methyltransferase from EST of *Salvia divinorum* Glands

Kutrzeba LM¹, Zjawiony JK^{1,2}, Koo HJ³, McDowell E³, Laurentzi A³, Gang DR³, Dayan FE⁴

¹ Department of Pharmacognosy, School of Pharmacy, University of Mississippi, University, MS 38677, USA

² National Center for Natural Products Research, Research Institute of Pharmaceutical Sciences, University of Mississippi, University, MS 38677, USA

³ University of Arizona, Department of Plant Sciences and BIOS Institute, Tucson, AZ 85721, USA

⁴ Natural Products Utilization Research Unit, Agricultural Research Service, U.S. Department of Agriculture, University, MS 38677, USA

Abuse of unregulated substances by young adults has been a great concern of the US and international community. The active component of *Salvia divinorum*, salvinatorin A (1) has a potent affinity to kappa opioid receptor in CNS. We studied the biosynthesis of this diterpenoid through the isolation of RNA and construction of cDNA library. Sequencing of the genetic material resulted in building an EST library containing all genes involved in biosynthetic assembly of 1. We then cloned and overexpressed carboxy methyltransferase

(CMT) gene in *Escherichia coli* to determine the substrate for the enzyme, and biochemically characterize it. We have employed ¹⁴C-SAM, and five different substrates to test for the CMT activity in the cell free assay. We observed methylation of C-18 carboxylic group in divinatorin A, divinatorin C and hardwickiic acid, but not in highly oxygenated substrates like salvinatorin A and B acids. This strongly suggests that CMT is substrate specific and that it is involved in the early stage of the pathway. Methyl esters of those substrates were independently synthesized to determine the products of the enzymatic reaction. Future work will involve purification of the enzyme and determination of K_M and K_{CAT} .

P-52

Free Energy Calculations on the Binding of Natural Latrunculins and Semi-synthetic Derivatives to G-Actin

Daga PR¹, Odde S¹, Hamann MT^{2,3}, Doerksen RJ^{1,3}

¹ Department of Medicinal Chemistry, School of Pharmacy, University of Mississippi, University, MS 38677,

Fax: 662-915-5638, E-mail: rjd@olemiss.edu

² Department of Pharmacognosy, School of Pharmacy, University of Mississippi, University, MS 38677

³ National Center for Natural Products Research, School of Pharmacy, University of Mississippi, University, MS 38677

Latrunculins are significant biological molecules isolated from *Neogombata* species, characterized by a macrocyclic lactone ring and a 2-thiazolidinone moiety. In vitro experiments revealed that the latrunculins disrupt actin polymerization. Despite having a wide variety of biological activities, their direct therapeutic use is limited by cytotoxicity. However modified latrunculins show great potential to have a wide range of useful biological activities including related to Alzheimer's disease [1,2]. We have designed a few synthetically feasible analogs of Latrunculin B with intentions to have compounds with reduced toxicity and better binding. Both naturally available and newly designed molecules were subjected to induced fit docking into G-actin. Molecular dynamics simulations and binding free energy (BFE) calculations of G-actin and the latrunculins were carried out. The docking studies revealed the binding mode of latrunculin B and analogs and were helpful to suggest possible modifications to reduce the toxicity [3]. The BFE calculations agreed well with actin polymerization inhibition data demonstrating that the recently isolated oxalatrunculin B binds more weakly than latrunculins A and B to G-actin. The binding of the latrunculins to G-actin and details of the protein-ligand interactions explain the decrease in activity of oxalatrunculin B and semi-synthetic analogs, reduced inhibition which should be beneficial for avoiding general toxicity.

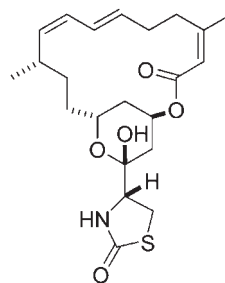

Latrunculin A

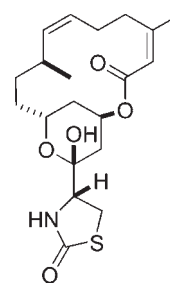

Latrunculin B

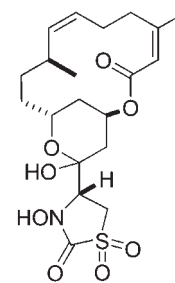

Oxalatrunculin B

Acknowledgements: NIH National Center for Research Resources C06 RR-14503-01 and 5P20RR021929; National Science Foundation EPS-0556308. PRD is a University of Mississippi NIH COR-E-NPN Natural Products Neuroscience Fellow. **References:** [1] Harms C, et al. (2004), *Mol Cell Neurosci*. 25: 69–82. [2] Fulga TA, et al. (2007), *Nat Cell Biol*, 9: 139–48. [3] Ahmed SA, et al. (2007), *Org Lett*, 9: 4773–4776.

P-53

Chemical Investigation of Two Species of the Family Cycadaceae

Ferreira D¹, Zjawiony JK¹, Moawad A^{1,2}, Hifnawy M², Hetta M²
¹ Department of Pharmacognosy, and National Center for Natural Products Research, School Of Pharmacy, The University of Mississippi, University, MS 38677, USA
² Department of Pharmacognosy, School of Pharmacy, University of Beni Suef, Egypt

Cycas is the only genus of the family Cycadaceae, order Cycadales. Chemical investigation of the constituents of the leaves of *Cycas revoluta* Thunb. and *C. circinalis* L. afforded the lignan lariciresinol (1), the flavanone naringenin (2) and 10 biflavonoids (3–12) which are derivatives of amentoflavone (A) and hinokiflavone (B). Five of these compounds were previously isolated [1,2] and seven are reported for the first time in *C. revoluta* Thunb. and *C. circinalis* L. The structures of these compounds have been established by detailed analysis of their spectroscopic, mainly 1D and 2D NMR and CD data. The antimicrobial, antimalarial, and antileishmanial activities were tested. **References:** [1] Varshney AK, et al. (1973), *Indian Journal of Chemistry*, 11(12): 1209–1214. [2] Gadek PA, (1982), *Phytochemistry*, 21(4): 889–890.

P-54

Productivity and Biochemical Composition of Peppermint Cultivars

Al-Amier H^{1,2}, Baek JP¹, El-Hela AA³, Helaly A², Craker LE¹
¹ Plant, Soil, and Insect Sciences Department, University of Massachusetts, Amherst, MA 01003
² Horticulture Department, Faculty of Agriculture, Al-Azhar University, Cairo, Egypt
³ Pharmacognosy Department, Faculty of Pharmacy, Al-Azhar University, Cairo, Egypt

Peppermint (*Mentha x piperita* L., Lamiaceae) is widely cultivated for the essential oil used worldwide in the confectionary and pharmaceutical industries. To determine oil characteristics of peppermint plants suitable for cultivation in salt-stress conditions of Egypt, 57 peppermint cultivars, obtained from National Clonal Germplasm Repository, Corvallis, Oregon were grown in a greenhouse at the University of Massachusetts-Amherst during 2007 and 2008 to determine growth characteristics and oil production. The essential oil was extracted from fresh aerial parts of each cultivar using steam distillation for 3 h to extract a pale, yellow colored, aromatic oil. The oils were analyzed by gas chromatography (FID, Cupelcowax 10 capillary column, 30 m × 0.25 mm film). Constituents were identified by co-chromatography with known standards. A high degree of variability among the cultivars for fresh weight and total essential oil was observed with the highest fresh weight per plant was obtained from cultivars labeled PM09 (144.5 g plant⁻¹)

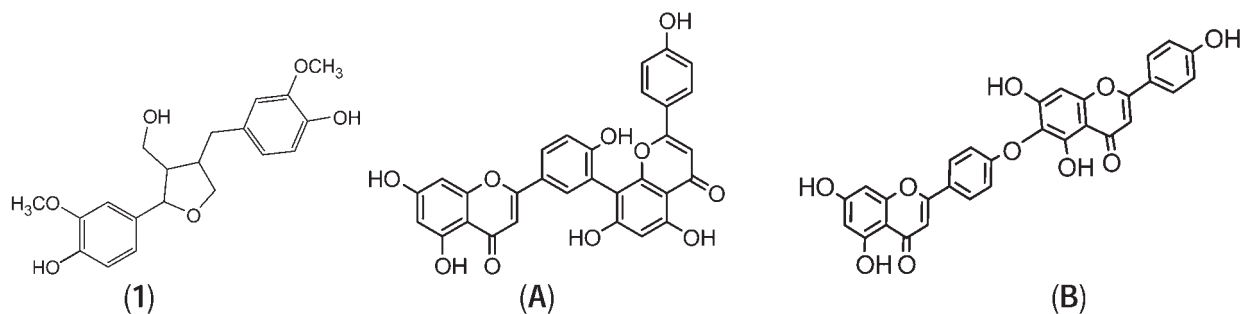

and PM01 (138.0 g plant⁻¹). The highest essential oil content was obtained from cultivars labeled MP07 (733.3 μL plant⁻¹) and MP52 (520.0 μL plant⁻¹). Menthone, menthol, and pulgone were the major constituents in all tested oils. The highest menthol content was measured in the oils from cultivars MP12 (85.93%) and MP56 (53.76%).

P-55

Essential Oil Components in Plant Organs of Japanese Spicebush

Baek JP¹, Park KW², Craker LE¹
¹ Division of Plant and Soil Sciences, University of Massachusetts, Amherst, MA 01003
² Division of Life Science and Biotechnology, University of Korea, Seoul, South Korea 136-701

Japanese spicebush (*Lindera obtusiloba* Blume, Lauraceae), which grows wild in mountainous areas of Korea, Japan and Northeast China, is known for odd-shaped leaves that are a light green color in the spring, a dark green color in the summer, and a vivid gold color in the fall. In Korea, the plant stem and bark have been used in traditional medicine and as an insect repellent, while spring leaves were used in making cookies and tea and the seed essential oil was used for lamplight and hair oil. To understand the multiple uses of plant organs, this study examined the essential oil from flowers, leaves, stems, and roots from plants collected in Gyeongju-Gii-Do, located in the northern part of South Korea. The essential oils were obtained by steam distillation/extract methodology using a Likens-Nickerson apparatus. Each extracted oil was analyzed by gas chromatography-mass spectrophotometry using an Agilent 6890 N GC connected to a Agilent 5975D (Agilent, U.S.A.). A HP-INNOWax polyethylene glycol capillary column (30 m × 0.25 mm) was used and the constituents were identified by comparison of the spectral data with that in the NIST mass spectral library, ver. 2.0 (NIST, U.S.A.). The essential oil content of the plant organs varied with the flower (0.25% F.Wt.) and young stem (0.23% F.Wt.) containing a higher concentration of oil than the leaf (0.08%, F.Wt.), old stem (0.05% F.Wt.) and root (0.05% F.Wt.). Main oil constituents were α-phellandrene and β-phellandrene in flower oil, caryophyllene in leaf oil, limonene in the stem oil, and camphene in the root oil.

P-56

Phytochemical and Biological Investigation of Bluebird Vine (*Petrea volubilis*)

El-Hela AA¹, Al-Amier H^{2,3}, Craker LE³
¹ Pharmacognosy Department, Faculty of Pharmacy, Al-Azhar University, Cairo, Egypt
² Horticulture Department, Faculty of Agriculture, Al-Azhar University, Cairo, Egypt
³ Division of Plant & Soil Sciences, University of Massachusetts, Amherst, MA 01002

A chemical analysis of bluebird vine (*Petrea volubilis*, Verbenaceae) (additional common names, queen's wreath and sandpaper vine) cultivated in Egypt as a botanical insecticide, identified the primary constituents as β-amyrin, stigmasterol, β-sitosterol, lupeol, and ursolic acid. The essential oil, extracted from fresh herb by hydrodistillation and analyzed by gas chromatography, had cineole (26.8%)

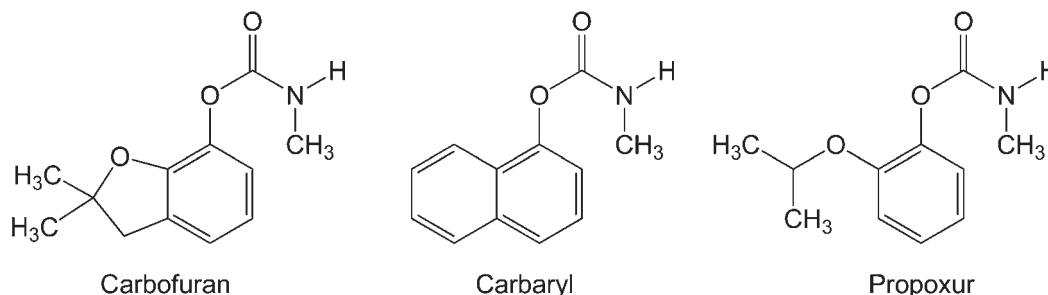

Fig. 1 N-methylcarbamates pesticides.

as the major constituent. The saponifiable and unsaponifiable constituents, subjected to GLC/MS for identification, indicated the presence of 17 saponifiable constituents with the major constituent being phytol (19%). A total of 14 fatty acids were identified as their methyl ester with methyl palmitate (35.1%) being the major constituent. Free sugars and polysaccharides were measured by HPLC and indicated the presence of sucrose, galactose, glucose, rhaminose, xylose, and arabinose. The petroleum ether and essential oil demonstrated antimicrobial activity against several microorganisms. The essential oil demonstrated insecticidal effects against the common housefly (*Musca domestica* L.) larvae with mortality rates of 80–100%.

P-57

Examination of Dechlorinating Anaerobic Microbes in Poly-chlorinated Biphenyl Contaminated Sediments in the Chesapeake Bay

Kopszywa J¹, Watts JEM², Sowers KR³

¹ Molecular Biology, Biochemistry, Bioinformatics, Towson University, Towson Maryland, 8000 York Rd Towson, MD 21252

² Biological Sciences, Towson University, Towson, Maryland, 8000 York Rd Towson, MD 21252

³ Center of Marine Biotechnology, University of Maryland Biotechnology Institute Baltimore, Maryland

Polychlorinated biphenyls (PCB) are common environmental contaminants that have been linked to many detrimental health conditions in humans and marine life. These industrially produced compounds were ubiquitously used in capacitors, transformers and frequently as coolants. PCBs were prized for their stability and lack of reactivity; however, these same properties allow PCBs to become persistent organic pollutants (POPs) in many environments. A number of different bioremediation strategies have been proposed, but as yet, no one method has been completely successful for PCB removal in the environment. Studying the microbial communities that survive within the PCB containing sediments may allow a better understanding for the anaerobic dehalogenation of these contaminants. In this study sediment samples were collected from eight locations with varying levels of PCB contaminants. Microbial DNA extractions, followed by PCR amplifications were successfully preformed utilizing a previously designed primer set used for amplifying known dechlorinating anaerobes. Restriction length polymorphisms (RFLP) analysis of the constructed clone library has shown that the diversity of this population is quite limited in a number of the Chesapeake Bay sediments. The limited diversification of anaerobes within the sediments may imply that the PCBs are acting as selection factors to facilitate the more adaptive anaerobes. Our future work will be focused on closer examination of the dominate anaerobes. Examination of the microbes associated with PCB dechlorination in contaminated sediments will provide a better understanding of this process in the environment.

P-58

Investigation on Processes of Degradation of N-Methyl Carbamate Pesticides under Environmental Aquatic Conditions

Pitter D¹, Muhoro C²

¹ Molecular Biology, Biochemistry and Bioinformatics,

² Department of Chemistry, Towson University, 8000 York Road, Towson, Maryland 21252

Carbamate compounds are useful pest control agents because they are alternatives to ozone-depleting organochloride pesticides, and because they are active against organophosphate-resistant pests. As a result, the use of carbamate pesticides has increased globally in recent years [1]. Despite this increase in use, there remain few accurate descriptions of the chemical fate of carbamate pesticides under environmental conditions. We report on studies on the aquatic chemical fate of three N-methyl carbamate pesticides used extensively in both urban and rural environments: carbofuran, carbaryl, and propoxur (Fig. 1). UV-vis and NMR spectroscopy were utilized to identify and monitor products of decomposition under various conditions. The results from characterization and kinetics studies, suggest that the degradation rates of these carbamate pesticides are governed by the identity of the substituent group on the benzene ring: carbaryl was found to hydrolyze fastest, followed by propoxur, and finally carbofuran. A mechanism for the pesticide decomposition is postulated and an explanation for the trend is proposed. Future work will investigate the reactivity of degradation products, in particular with water – soluble metals like copper (II), which are themselves components of pesticides. Thus, unexpected environmental coordination and/or organometallic reactions may be revealed in the future. **References:** [1] Hideyuki K, et al. (2005) Journal of Photochemistry and Photobiology A: Chemistry, 170: 239–245.

P-59

Isolation of Pyrrolizidine Alkaloid Isomers from *Symphytum* Species by Semi-Preparative Chiral Chromatography

Pawar RS¹, Grundel E¹, Mazzola E¹, White KD¹, Krynitsky A¹, Rader JI¹

¹ Center for Food Safety and Applied Nutrition, Food and Drug Administration 5100 Paint Branch Parkway, College Park, MD 20740

Comfrey is a common name given to plants belonging to the genus *Symphytum* (family Boraginaceae) [1]. The comfrey root and leaf contain varying levels of the hepatotoxic pyrrolizidine alkaloids (PAs) that have been reported to cause veno-occlusive disease in humans [2]. However, the exact alkaloid profile of different species has not been clearly established, in part because comfrey PAs are not commercially available and the isolation of the individual isomers is difficult. Milligram quantities of PA components from *Symphytum* are needed for use as analytical standards in quantitating these components in dietary supplements containing these botanicals. Results will be presented on the isolation of PAs from the roots of *S. uplandicum*. Briefly, a 1.0 kg quantity of plant material was extracted with methanol and the PAs were reduced with zinc dust to convert the N-oxides to free bases. The PAs were enriched on a Chem Elut cartridge (Varian Inc.) and then fractionated on a silica

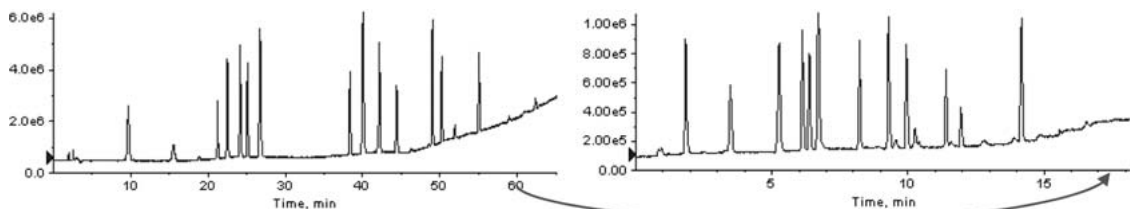

Fig. 1

gel chromatographic column, followed by further isolation by semi-preparative HPLC. For the compounds occurring as racemic mixtures, their separation was achieved by semi-preparative chiral HPLC. These chiral stationary phases consist of cellulose immobilized on silica with carbamates as chiral selectors (Chiralpak IA and IC, Chiral technologies Inc. West Chester PA). The compositions of individual fractions were monitored by GC-MS or LC-MS and the purified components were characterized by mass and NMR spectroscopic studies [3–5]. The isolated PAs will be used for the development of analytical methods that can be applied to develop chemical profiles of different species of *Symphytum* and to determine alkaloid contents of comfrey preparations sold in the market. References: [1] Botanical Safety Handbook 1997 CRC Press, FL [2] Mei N, et al. (2005) British Journal of Cancer 92: 873–875. [3] Logie CG, et al. (1994) Phytochemistry, 37: 43–109. [4] Roeder E, et al. (1990), Phytochemistry, 29: 11–29. [5] Kim NC, et al. (2001) Journal of Natural Products, 64: 251–253.

P-60

¹H-NMR Method Validation for Quantitative Analysis of Aloe Products

Jiao P¹, Weaver S², Milligan G², Jia Q¹

¹ Unigen, Inc., 2660 Willamette Drive NE, Lacey, WA 98516, USA

² Department of Chemistry, Saint Martin's University, 5300 Pacific Ave., Lacey, WA 98503, USA

Development and validation of a reliable analytical method to analyze complicated natural ingredients derived from popular medicinal plant *Aloe vera* have been challenging. Fresh *Aloe vera* consists of three major components: acetylates polysaccharides, glucose, and malic acid, which are markers for good aloe materials. High content of lactic acid and acetic acid indicate bacterial degradation, hydrolysis and thermal degradation of the material. A proton NMR method was developed by Dr. Bernd Diehl at Spectral Service, Köln, Germany, and accepted by IASC as an analytical method to certify aloe based ingredients and finished products. This presentation will report the validation of the quantitative NMR method according to the AOAC guidelines. The validation includes specificity, linearity, accuracy, robustness, repeatability and reproducibility, limit of detection and limit of quantification. Data was collected with two different NMR instruments in two independent NMR labs. This simple and non-destructive ¹H NMR method was able to quantify the amount of acetylated polysaccharides, glucose, malic acid, lactic acid and acetic acid in *Aloe vera* powder. Acknowledgements: Support from the International Aloe Science Council (IASC) is gratefully acknowledged.

P-61

Quality Control of Botanicals through Identification and Quantification of Multiple Characteristic Components by Ultra-Fast HPLC-DAD-ELSD and LC-TOF/MS

Qi LW¹, Li P¹

¹ Key Laboratory of Modern Chinese Medicines, China Pharmaceutical University, Ministry of Education; Nanjing 210009, China

Over the last decades, the usage of botanicals for herbal medicines has expanded globally. Safety and efficacy as well as quality control of botanicals-derived products have become important concerns. Addressing these topics usually relies on validated analytical meth-

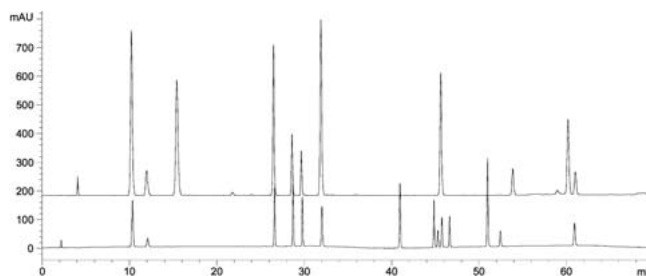

Fig. 2

ods, which allows rapid and sensitive identification and quantification of relevant constituents. Botanicals are complex mixtures consisting of thousands of compounds, and getting useful chemical information from these highly complicated matrixes has long been one of the major challenges to chemists and analysts. In this report, we introduced two most potential and prospective methods for quality control of botanicals, i.e., ultra-fast HPLC-DAD-ELSD method and ultra-fast HPLC-TOF/MS method. This report includes three important aspects: (i) We applied ultra-fast HPLC system to routine analysis and quality control of botanicals, providing up to 5–20 times faster analysis and 60% higher resolution than conventional HPLC without sacrificing resolution, precision or sensitivity (Fig. 1). (ii) We connected UV/DAD with ELSD for simultaneous determination of various compounds in one run. UV could detect strong UV absorbing compounds such as isoflavonoids, phthalides, and phenolic acids, while as a complementation role, ELSD could detect non- or poor UV absorbing compounds such as saponins (Fig. 2). (iii) We suggest that TOF-MS provides much higher sensitivity and selectivity, as well as accurate mass measurement. It enables the simultaneous identification and determination of compounds in botanicals even with trace contents. Acknowledgements: Financial support for this research from the National Science Foundation of China (No. 90709020, 30530870) is gratefully acknowledged.

P-62

Qualitative and Quantitative Analysis of Steroidal Alkaloids in *Fritillaria* Species by Solid-Phase Extraction followed by Rapid Resolution LC/TOF-MS

Zhou JL¹, Li P¹

¹ Key Laboratory of Modern Chinese Medicines, China Pharmaceutical University, Ministry of Education; Nanjing 210009, China

Steroidal alkaloids are naturally occurring nitrogen-containing compounds in many edible or medicinal plants, such as potato, tomato, *Fritillaria* and American hellebore, which possess a variety of toxicological and pharmacological effects on humans. Such biological effects of these compounds create a critical demand for developing a sensitive and selective analytical method to accurately evaluate the presence and content of the major and minor steroidal alkaloids in these plants. In this report, we present a high-selective and sensitive method for rapid analysis of steroidal alkaloids in *Fritillaria* species, utilizing selective solid-phase extraction and rapid resolution liquid chromatography/time-of-flight mass spectrometry (SPE-RRLC/TOF-MS). The selective solid-phase extraction step was developed using a mixed-mode cation-exchange/reversed-phase cartridge (Oasis MCX). The strong cation exchange capacity of MCX can selectively capture basic analytes and remove acidic

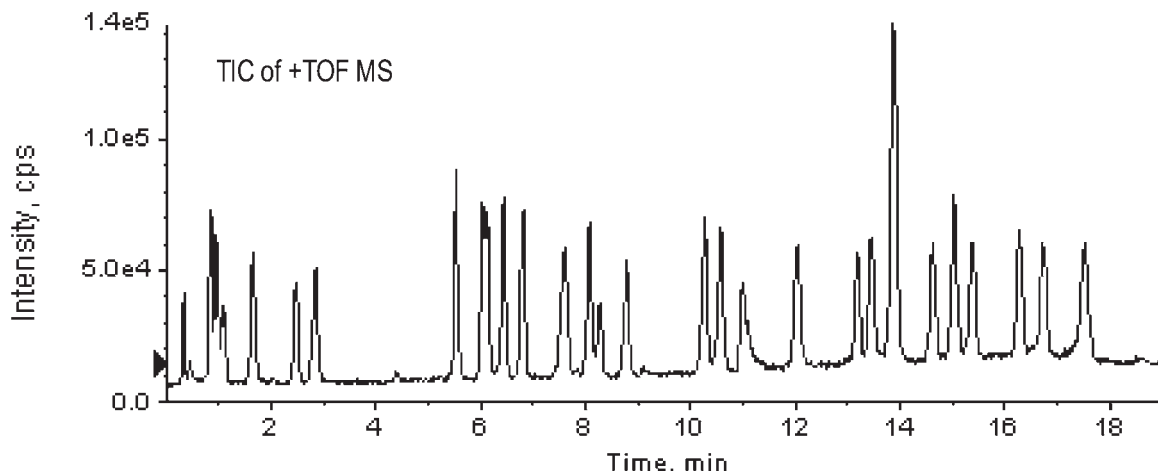

Fig. 1 Representative total ion chromatograms (TIC) of 26 steroidal alkaloids and internal standard. For those with poor separation, extraction ion mode was used to achieve reliable quantification, because they had different molecular weight.

and neutral compounds in the plant extract, thereby reducing the matrix effect and improving the MS detection sensitivity. The sample recoveries on Oasis MCX cartridges were found to be > 80%. The analysis of steroidal alkaloids was carried out by RRLC/TOF-MS. The use of RRLC can shorten analytical time and improve chromatographic resolution, and TOF-MS provides abundant structure information by accurate mass measurements for each molecular ion and fragment ions at different fragmentor voltage. As a result, the SPE-RRLC/TOF-MS was successfully used for simultaneous determination of 26 steroidal alkaloids in different *Fritillaria* species in a single run within 18 min (Fig. 1), which is 5-times faster than conventional HPLC/TOF-MS method [1]. **Acknowledgements:** Financial support for this research from the cultivation fund of the key scientific and technical innovation project, Ministry of Education of China (No. 2004-295). **References:** [1] Zhou JL, Li P, (2008) *J Chromatogr A*, 1177: 126–137.

P-63

Determination of Terpene Lactones in *Ginkgo Biloba* Using Liquid Chromatography-Electrospray Tandem Mass Spectrometry

Huang L¹, Sun S¹

¹ Silliker JR Laboratories ULC, #12-3871 North Fraser Way, Burnaby, BC, Canada, V5G 5J6

Ginkgo biloba (ginkgo), used in traditional Chinese medicine for many centuries, is one of the most popular botanical dietary supplements in North America. Commercial ginkgo products are usually standardized to the levels of flavonoids and terpene lactones (ginkgolides A, B, C, J, and bilobalide) based on the biological activities. Flavonoids have strong UV absorption. However, terpene lactones are very inactive to UV, refractive index, and ELSD detections therefore their quantitation requires complicated pre-purification and difficult HPLC separation to eliminate interferences and to resolve all analytes even though their concentrations are high in ginkgo extracts. In this study, we developed and validated a sensitive, accurate and reliable assay method for determination of terpene lactones in ginkgo products using HPLC-electrospray tandem mass spectrometry (LCMSMS) technique, which minimized the requirements of major sample cleanup and chromatographic resolution. The validation of the method showed that the analyte recoveries are in the range of 90–110%, and the relative standard deviations are less than 10% for all five analytes, ginkgolide A, B, C, J and bilobalide. **References:** [1] Yongkai S, et al. (2005), *J Mass Spectrom*, 40: 373–379.

P-64

The NIH/ODS Analytical Methods and Reference Materials Program for Dietary Supplements: Five-Year Accomplishments and Future Directions

Betz JM¹, Saldanha LG¹, Fisher KD¹, Coates PM¹, Klein M¹, Engel J¹, Nguyen Pho A², Sharpless KE³, Sander LC³, Wise SA³, Rimmer CA³, Phinney KW³

¹ Office of Dietary Supplements, U.S. National Institutes of Health, Bethesda, MD, 20892 USA

² U.S. Food and Drug Administration, Silver Spring, MD 20993, USA

³ National Institute of Standards and Technology, Gaithersburg, MD, 20899 USA

Quality of natural health products remains a challenge to regulators, researchers, and manufacturers. Quality parameters include specifications for sanitation, contaminants, and content of natural chemicals. Validated analytical methods and reference materials to ensure the purity and strength of natural health products are essential. Because these products and their ingredients are often complex mixtures they pose analytical challenges, and methods validation may be difficult. In response to concerns about quality, in 2002 the U.S. Congress directed the Office of Dietary Supplements at the National Institutes of Health to accelerate methods validation, and the Analytical Methods and Reference Materials Program (AMRM) was created. The program is stakeholder driven and provides a coordinated approach to validation that facilitates methods validation and production of reference materials. The major accomplishments of the first five years of the AMRM program involve collaborative efforts with FDA, AOAC, and NIST. The program has resulted in 18 collaborative studies of analytical methods. Twelve methods have been approved as Official Methods of Analysis (OMA), and 3 of these are final action OMA. The NIST reference materials project has resulted in the production of 5 suites of standard reference materials, with an additional 12 suites in various stages of completion. The NIST has also created a pilot Laboratory Quality Assurance Program that will assist laboratories to become proficient at analysis. A more detailed account of these accomplishments and an outline of the future scope and direction of the program will be presented.

P-65

Determination of Trace Element Contents in Solid Environmental Matrices using Collision/Reaction Cell ICP-MS

Duzgoren-Aydin NS^{1,2}, Avula B¹, Willett KL^{1,2}, Khan IA^{1,2}

¹ National Center for Natural Products Research Program and

² Environmental Toxicology Research Program, The School of Pharmacy, University of Mississippi, MS 38677

Objectives of this study were to: a) optimize EPA-3052 microwave digestion method using a c/r ICP-MS method by adjusting combinations of acids, digestion temperature and duration; b) validate the c/r ICP-MS method for multi-element analyses to determine their total concentration in solid matrices; and c) set up a robust single-step partial extraction method by using the c/r ICP-MS method. Here, special emphasis has been given to total trace element analyses of marine sediment samples from the Back Biloxi Bay, MS to monitor the effects of Hurricane Katrina on the region. This study confirmed that the amount of acid extraction not only depends on the applied digestion method including different types and combinations of acids, but also the type of element, its origin (natural or anthropogenic) and its chemical form. Optimized conditions for total digestion have been selected as-Acid: HNO₃+ HF + HCl (10 : 3 : 2); Temperature: 180 °C; Power: 1600 W; and Duration: 15 minutes. The dilute acid (single-step) microwave digestion methods extract a significant amount of trace elements from sediment solid matrices, therefore these methods can lead to overestimation of the amount of trace elements that might be released into the environment. The dilute acid (0.5 M HCl) (single-step) "cold" extraction method can provide valuable information for evaluating the amount of trace metal that might become remobilized and/or bioavailable. Total trace element contents of marine sediments from Back Biloxi Bay, collected monthly following Hurricane Katrina, revealed a wide range of variation, but no apparent temporal trends. **Acknowledgement:** This study was supported by NOAA-NIUST-NA05NOS4261163.

P-66

Chromatographic Method Comparisons for the Determination of Magnoflorine and Triterpene Saponins from Roots of Blue Cohosh (*Caulophyllum thalictroides*)

Avula B¹, Wang YH¹, Rumalla CS¹, Ali Z¹, Smillie TJ¹, Khan IA^{1,2}

¹ National Center for Natural Products Research, Research Institute of Pharmaceutical Sciences,

² Department of Pharmacognosy, School of Pharmacy, The University of Mississippi, MS 38677, USA

The roots of *Caulophyllum thalictroides* is traditionally used for the treatment of menstrual difficulties and as an aid in childbirth. *C. thalictroides* is known to contain saponins which are considered to be responsible for the uterine stimulant effects together with teratogenic alkaloids [1]. A comparison study between HPLC-UV-ELSD, UPLC-UV-ELSD and HPTLC methods was presented for the determination of major alkaloid and triterpene saponins from roots of *Caulophyllum thalictroides* (blue cohosh) and dietary supplements claiming to contain blue cohosh. The procedure involves the common extraction of the alkaloid and saponins from the plant and dietary samples. By liquid chromatography method with PDA and ELSD, C18 column, mobile phase consisted of solvent A (10 mM ammonium acetate) and solvent B (acetonitrile). Owing to their low UV absorption, the triterpene saponins were detected by evaporative light scattering. Within 35 minutes for HPLC-UV-ELSD method and within 8.0 minutes for UPLC-UV-ELSD method, eight triterpene saponins [cauloside H (2), leoticin D (3), cauloside G (4), cauloside D (5), cauloside B (6), cauloside (7), cauloside (8) and saponin PE (9)] and magnoflorine (1) could be separated, with detection limits of 1–5 µg/mL for saponins and 0.05 µg/mL for magnoflorine by UPLC method, respectively. The methods were successfully used to analyze different dietary products. For the products containing blue cohosh, there was a significant variability in the amounts of the triterpene saponins. The compounds in plant materials and commercial products of blue cohosh were further confirmed by LC-MSD-TOF.

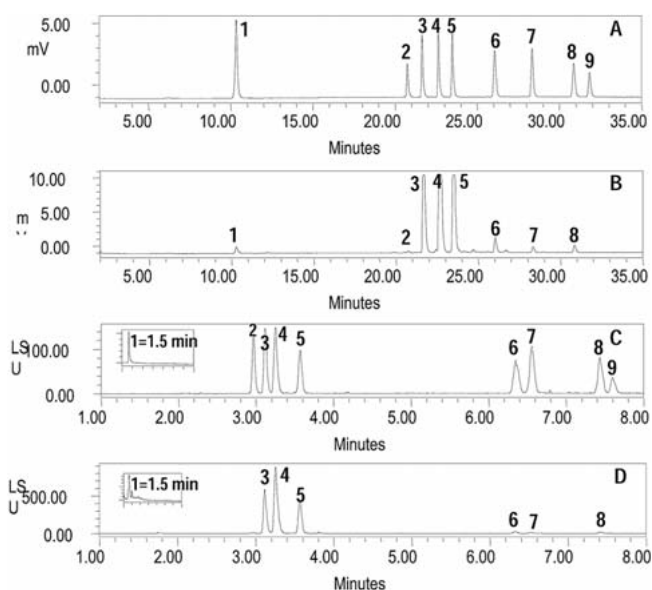

Fig. 1 HPLC (A, B) and UPLC (C, D) chromatograms of a mixture of standard (A, C), and roots of blue cohosh (B, D).

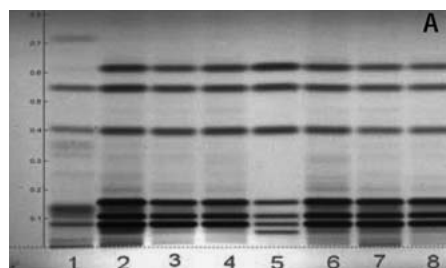

Fig. 2 Comparison of blue cohosh with dietary products by HPTLC method. Tracks: 1–3, 7, 8; dietary supplements, 5, standard mix-8; 4 & 6, roots of blue cohosh under visible light (Saponins) (A) and at 366 nm (Magnoflorine) (B).

Acknowledgements: This research is funded in part by "Science Based Authentication of Dietary Supplements" Funded by the Food and Drug Administration grant number 2 U01 FD 002071-07. The authors would like to thank Annette Ford, University of Mississippi for extraction of samples. **References:** [1] Ganzera M, et al. (2003) *Phytochem Anal*, 14: 1–7.

P-67

Quantitative Determination of Pregnanes from *Caralluma fimbriata* by using HPLC-UV Method and Identification by LC-ESI-TOF

Avula B¹, Shukla YJ¹, Wang YH¹, Smillie TJ¹, Khan IA^{1,2}

¹ National Center for Natural Products Research, Research Institute of Pharmaceutical Sciences,

² Department of Pharmacognosy, School of Pharmacy, The University of Mississippi, MS 38677, USA

Caralluma fimbriata, Fam. Asclepiadaceae, is a succulent plant and plants from *Caralluma* genus occur throughout Africa, and Asia, majority being indigenous to the Indian subcontinent and Arabian peninsula. Recently it has gained popularity as a weight-loss dietary supplement [1]. An HPLC method with UV detection for analysis of five pregnane compounds from *Caralluma fimbriata* was developed. The simultaneous chromatographic separation of the five compounds was achieved with a Gemini NX reversed phase C18 column, using gradient mobile phase of water and acetonitrile, both containing 0.1% acetic acid, aided with a detection using a PDA detector. This method was applied to the fingerprint identification of three plant materials of *C. fimbriata* and seven dietary supplements containing *C. fimbriata*. The five pregnane derivatives, boucerin (1), caraumbelloside I (2), caraumbelloside III (3), caraumbelloside II (4)

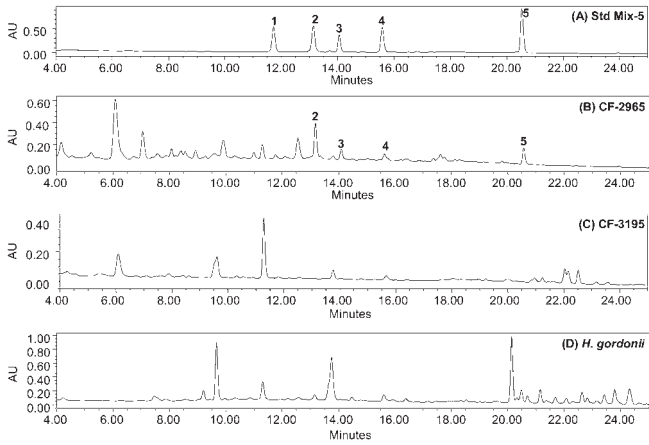

Fig. 1 Comparison of HPLC profiles of mixed standards (A); *Caralluma fimbriata* extract (B) and plant material (C), *Hoodia gordonii* (D) at wavelength 205 nm. (1) Boucerin, (2) Caraumbelloside I, (3) Caraumbelloside II, (4) Caraumbelloside II, (5) Caraumbellogenin.

and caraumbellogenin (5) have been quantitatively identified in the plant extracts. The limit of detection (LOD), and limit of quantitation (LOQ) were in the range from 1–5 µg/mL, and 3–15 µg/mL for compounds 1–5, respectively. This method also provides a distinction between the chromatographic profiles of *Caralluma*, *Hoodia*, and *Opuntia spp.*, and thus can be aptly employed to distinguish between these plant materials or the botanical products thereof. In the ES positive ion mode, the $[M+Na]^+$ ions at m/z 373.23, 679.33, 841.41, 517.27 and 355.22 were observed for compounds 1–5. **Acknowledgements:** This research is funded in part by “Science Based Authentication of Dietary Supplements” Funded by the Food and Drug Administration grant number 2 U01 FD 002071-07. **References:** [1] Kuriyan RT, et al. (2007) *Appetite*, 48: 338–344.

P-68

Quantitative Determination of Curcuminoids from Roots of *Curcuma longa*, *Curcuma* Species and Dietary Supplements by UPLC-UV-MS Method

Avula B¹, Wang YH¹, Smillie TJ¹, Khan IA^{1,2}

¹ National Center for Natural Products Research,

Research Institute of Pharmaceutical Sciences,

² Department of Pharmacognosy, School of Pharmacy,

The University of Mississippi, MS 38677, USA

The rhizomes of turmeric (*Curcuma longa* L., Zingiberaceae) play an important role as a coloring agent in foods, cosmetics and textiles [1]. The main yellow bioactive substances in the rhizomes are due to curcumin and two related demethoxy compounds, demethoxycurcumin and bisdemethoxycurcumin. Turmeric has been reported to possess anti-inflammatory, hepatoprotective, antitumour, antiviral activities, anticancer activities and is also used in gastrointestinal and respiratory disorders [2–3]. An HPLC method was developed for the determination of curcuminoids from roots of *Curcuma longa* L., different species of *Curcuma* (*C. zedoaria*, *C. phaecaulis*, *C. wenyujin* and *C. kwangsiensis*) and dietary supplements that claim to contain *C. longa*. The separation was achieved within 3.5 minutes by using C-18 column material, a water/acetonitrile mobile phase, both containing 0.05% formic acid gradient system and a temperature of 35 °C. The method was validated for linearity, repeatability, limits of detection (LOD) and limits of quantification (LOQ). The limits of detection and limits of quantification of curcuminoids were found to be 0.01 µg/mL and 0.035 µg/mL, respectively. The wavelength used for quantification with the diode array detector was 420 nm for curcuminoids and 240 nm for Ar-turmerone. The total content of curcuminoids was found to be in the range from 0.825–35.37% in different species of *C. longa* and dietary supplements. The curcuminoids were not detected in roots of *C. wenyujin* and *C. kwangsiensis*. The developed method is simple, economic, rapid and especially suitable for quality control analysis of curcuminoids. **Acknowledgements:** This research is funded in part by “Science Based Authentication of Dietary Supplements” Funded by the Food and Drug Administration grant number 2 U01 FD 002071-07. The authors would like to thank Dr. Aruna Weerasooriya, University of Mississippi for providing the plant samples and Annette Ford, University of Mississippi for extraction of samples. **References:** [1] Sekar N, (2004), *Colourage*, 51: 59–60. [2] Ammon HTP, Wahl MA, (1991), *Planta Med*, 57: 1–7. [3] Radha KM, et al. (2006), *Life Sci*, 78: 2081–2087.

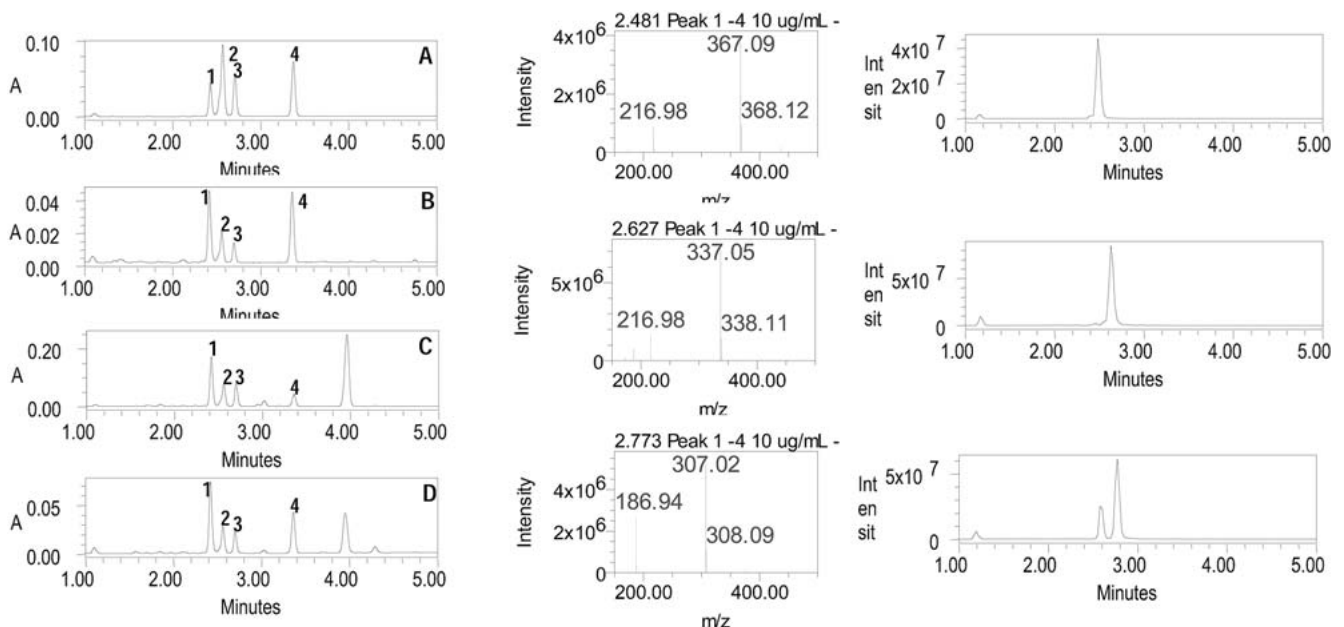

Fig. 1 UPLC Chromatograms of a mixture of standard (A), roots of *C. longa* (B–C) and dietary supplement (D) at 254 nm. (1) curcumin, (2) desmethoxycurcumin, (3) bisdesmethoxycurcumin, (4) Ar-turmerone.

P-69

Extraction and Analysis of Alkaloids from Roots of Goldenseal and Dietary Supplements by Using UPLC-UV-MS Methods

Avula B¹, Wang YH¹, Smillie TJ¹, Khan IA^{1,2}

¹ National Center for Natural Products Research, Research Institute of Pharmaceutical Sciences,

² Department of Pharmacognosy, School of Pharmacy, The University of Mississippi, MS 38677, USA

The roots of *Hydrastis canadensis* (goldenseal) are popular phyto-medicines for the treatment of gastrointestinal disorders and upper respiratory tract infections [1–2]. Simple and fast UPLC-UV-MS methods were developed for the quantification of the major constituents, berberine and hydrastine from roots of *Hydrastis canadensis* L. and dietary supplements containing goldenseal and *Echinacea purpurea*/goldenseal combination formulations. The extraction (with acidified water and methanol) and analysis were applied to several other alkaloids including canadine, hydrastinine, palmatine, coptisine, and jatrorrhizine by a UPLC method with PDA and MS, C18 column. The mobile phase consisted of solvent A (50 mM ammonium formate, pH 3.3) and solvent B (acetonitrile with 0.05% formic acid). The developed method was validated for all the parameters tested and successfully applied to the identification of seven alkaloids in plant sample and ten dietary supplements. The plant material and ten dietary supplements were found to contain major alkaloids, hydrastine and berberine. One commercial product also contained palmatine, coptisine and jatrorrhizine, thus indicating that the material was not pure goldenseal. LC-mass spectrometry coupled with electrospray ionization (ESI) method is described for the identification of seven alkaloids in plant sample and dietary supplements. This method involved the use of the [M]⁺ ions for coptisine, jatrorrhizine, palmatine and berberine, [M+H]⁺ ions for hydrastine and canadine, [M+H-18]⁺ ions for hydrastinine in the positive ion mode with selective ion recording (SIR).

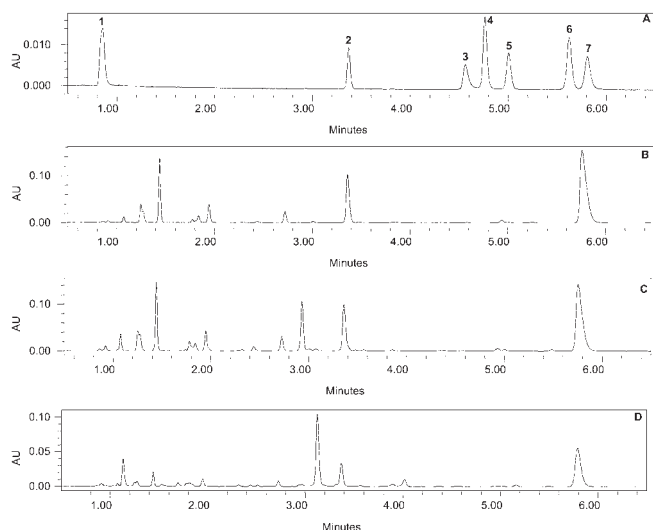

Fig. 1 UPLC Chromatograms of a mixture of standards (A), roots of goldenseal (B) and dietary supplements (C–D) at 290 nm. 1 hydrastinine, 2 hydrastine, 3 coptisine, 4 jatrorrhizine, 5 canadine, 6 palmatine and 7 berberine.

Acknowledgements: This research is funded in part by “Science Based Authentication of Dietary Supplements” Funded by the Food and Drug Administration grant number 2 U01 FD 002071-07. The authors would like to thank Annette Ford, University of Mississippi for extraction of samples. **References:** [1] Brown PN, Roman MR (2008), J. AOAC International, 91(4): 694–701. [2] Abourashed EA, Khan IA, (2001), J. Pharm. Sciences, 90(7): 817–822.

P-70

Determination of Heavy Metals in Botanicals and Dietary Supplements by Using Collision/Reaction Cell ICP-MS: Comparison of Microwave Digestions Assisted by Six Types of Digestion Mixtures

Avula B¹, Wang YH¹, Smillie TJ¹, Khan IA^{1,2}

¹ National Center for Natural Products Research, Research Institute of Pharmaceutical Sciences,

² Department of Pharmacognosy, School of Pharmacy, The University of Mississippi, MS 38677, USA

Heavy metals are natural components of the earth’s crust and are widely used in agricultural, manufacturing and food/material processing industries. Some heavy metals such as selenium, iron, copper, chromium and zinc are essential at low concentrations, others such as arsenic, cadmium, lead and mercury are toxic. Determination of 11 metals (including arsenic, chromium, mercury, iron, copper, nickel, zinc, selenium, lead, cadmium and thallium) in botanicals and dietary supplements were carried out by using ICP-MS. Closed vessel microwave digestion of two plant samples and one product assisted by HNO₃+HCl (8:2) (Procedure-A), water (Procedure-B), methanol (Procedure-C), HNO₃ (Procedure-D), 0.5 M HCl (Procedure-E) and HNO₃ +6M HCl (Procedure-F) were used to determine the recovery of 11 metals by ICP-MS. Sample digestion was done in a MARS 5 microwave. Elemental measurements were performed using Agilent 7500 ce CRC-ICP-MS operating in hydrogen mode for Se and Fe, and He mode for As, Cr, Cu, Ni, Cd to remove spectral interferences. The method was validated for linearity, repeatability, limits of detection (LOD) and limits of quantification (LOQ). The limits of detection and limits of quantification for these heavy metals were found to be 0.004–0.51 ppb. Digestions A, D and F gave significantly higher recoveries than compared with other digestions. Microwave digestion followed by analysis by IC-PORS-MS has been shown to be a simple, reliable method for the multi-element determination of trace metals in dietary supplements and botanicals. About 12 plant samples and 22 dietary products were analyzed and all were found to contain Fe, Zn, Cu, Cr, and Ni. Four samples for As and one sample for Cr were found to contain elevated concentrations above the recommended limit. **Acknowledgements:** This research is funded in part by “Science Based Authentication of Dietary Supplements” Funded by the Food and Drug Administration grant number 2 U01 FD 002071-07. **References:** [1] Dolan SP, et al. (2003), J Agric & Food Chem, 51: 1307–1312.

P-71

Identification of Isoflavonoids from Leaves of *Pueraria montana* (Lour.) Merr. var. *lobata* (Willd.) and its Comparative Studies with Roots of *Pueraria lobata* by Using HPLC-ESI-MSD-TOF and MS-MS Methods

Avula B¹, Wang YH¹, Smillie TJ¹, Khan IA^{1,2}

¹ National Center for Natural Products Research, Research Institute of Pharmaceutical Sciences,

² Department of Pharmacognosy, School of Pharmacy, The University of Mississippi, MS 38677, USA

Radix of *Pueraria* spp. is a popular traditional Chinese medicine. Kudzu has been traditionally used in China to treat diabetes, alcoholism, gastroenteritis (inflamed stomach or intestine), and has shown to have cardiovascular, neurological, anti-oxidant properties [1,2]. Kudzu (*Pueraria lobata*, Family Fabaceae) is a rich source of isoflavones and isoflavone glycosides, which include puerarin, daidzin, genistin, genistein, daidzein, and daidzein-4’, 7-diglucoside. Puerarin and daidzin were the major isoflavone glucosides in kudzu root in comparison with kudzu leaf. LC-MSD-TOF and MS-MS tools have been employed for profiling and characterization of isoflavones and isoflavone glycosides including distinction between flavonoid O- and C-glycosides. The mass spectrum of O-glycoside is generally characterized by the presence of an abundant fragment ion resulting from (terminal) glycosyl cleavage and the aglycone moiety of C-glycoside was not produced. Thus puerarin ($m/z = 416.10$) and daidzin ($m/z = 416.10$) are readily distinguished. These two glucosides with [M-H]⁻ at m/z 415.10 and [M+H]⁺ at m/z

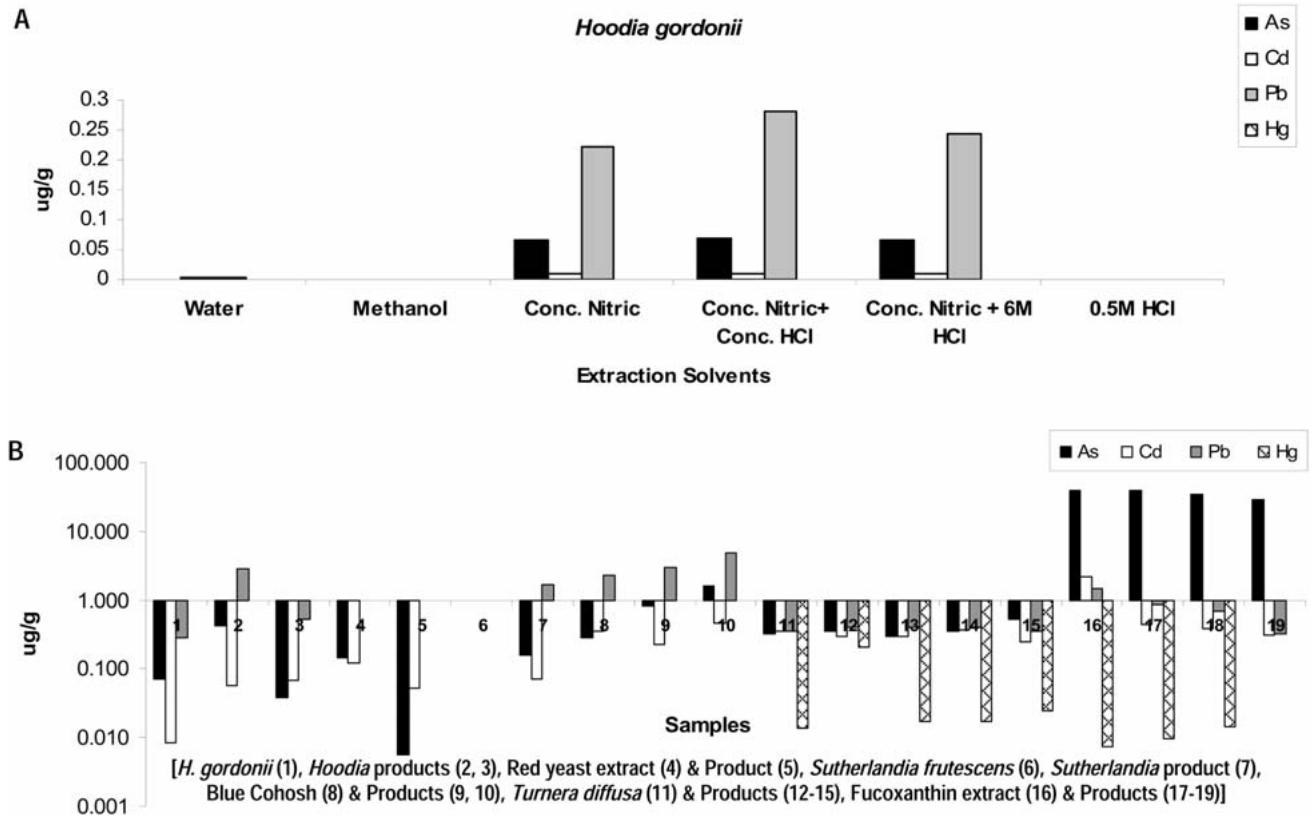

Fig. 1 Extraction (A) and Heavy Metal analysis of Botanicals and Dietary Supplements (B) using ICP-MS method.

417.12 were well resolved chromatographically ($t_r=17.83$ and 20.18 min). These were characterized by losses of 120 and 162 amu upon fragmentation, respectively. The loss of 120 amu is characteristic of C-glycoside flavonoids. **Acknowledgements:** This research is funded in part by “Science Based Authentication of Dietary Supplements” Funded by the Food and Drug Administration grant number 2 U01 FD 002071-07. The authors would like to thank Annette Ford, University of Mississippi for extraction of samples. **References:** [1] Prasain JK, et al. (2007), Phytochem. Analysis, 18: 50–59. [2] Lukas SE, et al. (2005), Alcohol Clin Exp Res, 29(5): 756–762.

P-72 Quantitative Determination of Lovastatin from Dietary Supplements Containing Red Yeast Rice Extracts by using HPLC-UV-MS and UPLC-UV-MS Methods
 Ayula B¹, Wang YH¹, Smillie TJ¹, Khan IA^{1,2}
¹National Center for Natural Products Research, Research Institute of Pharmaceutical Sciences,
²Department of Pharmacognosy, School of Pharmacy, The University of Mississippi, MS 38677, USA

Red yeast rice is produced by cultivating *Monascus purpureus* on polished rice. China is the world’s largest producer of red yeast rice. Red yeast rice may provide benefits beyond those provided by stat-

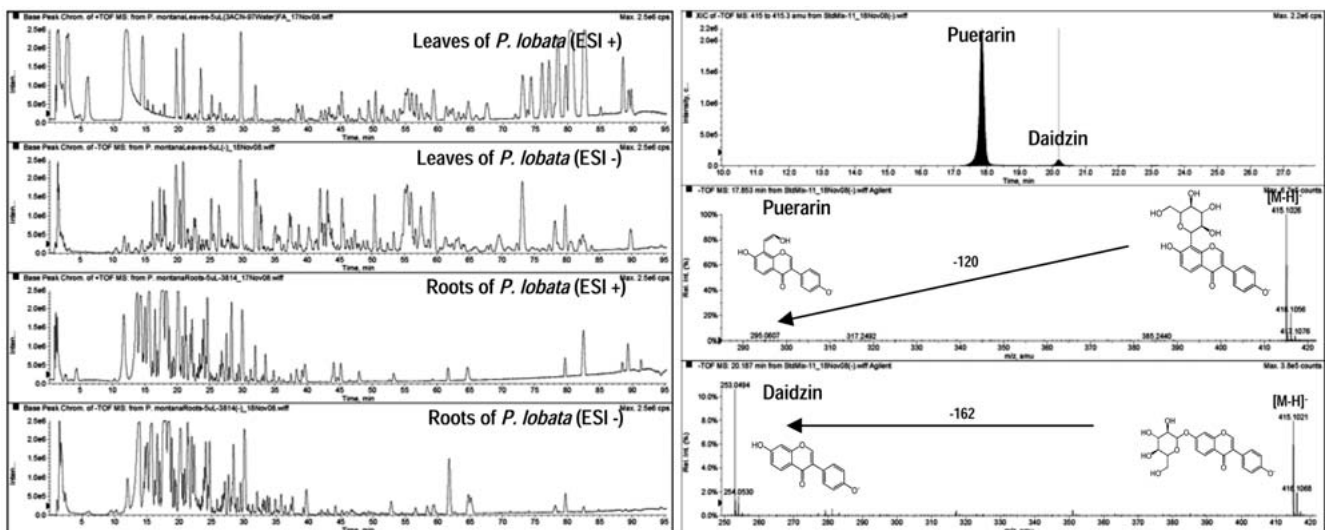

Fig. 1 Base peak chromatograms of leaves and roots of *Pueraria lobata* at positive and negative mode of ionization.

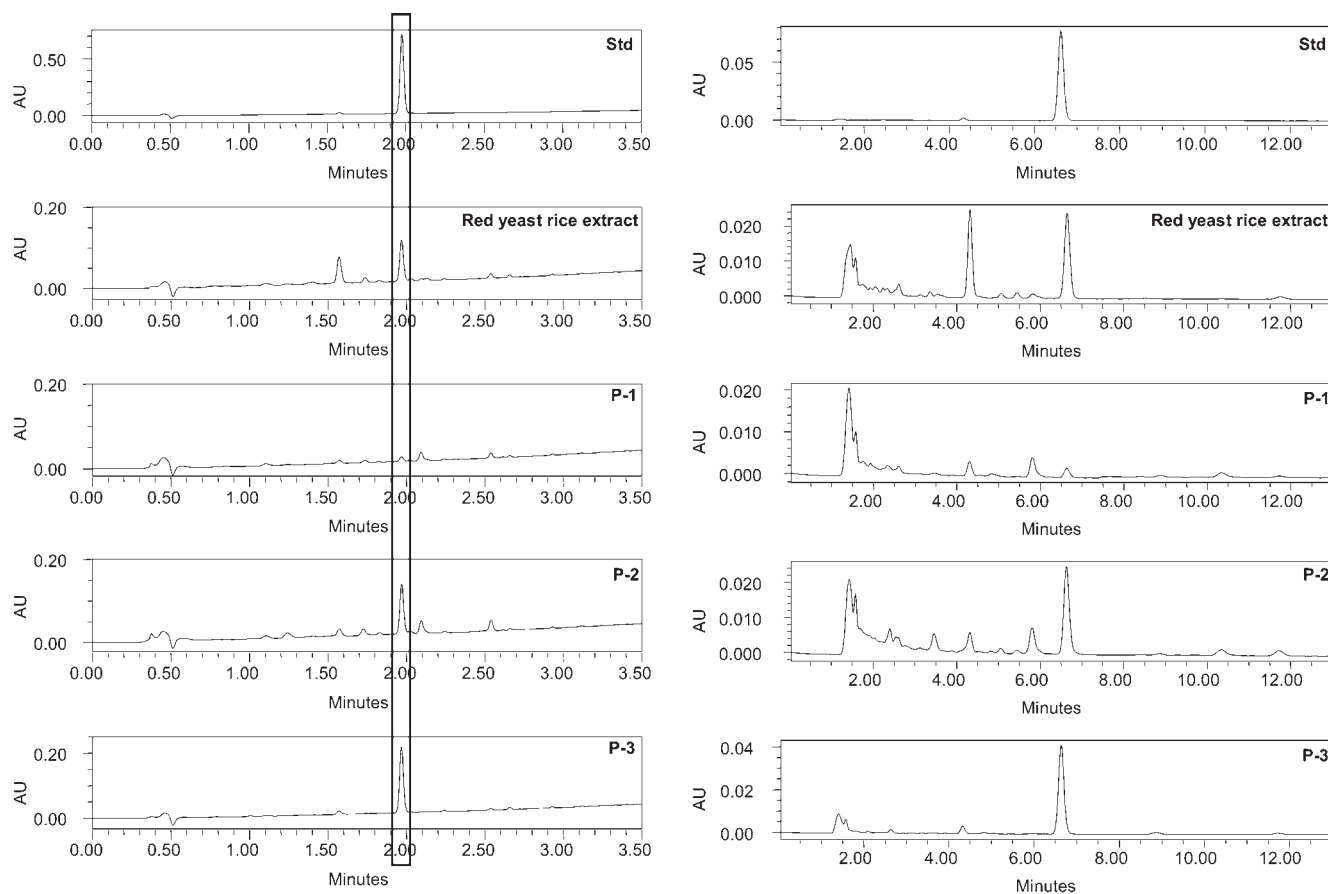

Fig. 1 UPLC-UV and HPLC-UV chromatograms of lovastatin, red yeast rice extract and dietary supplements (P-1 to P-3) at 238 nm.

ins. Researchers have reported that the benefits seem to exceed those reported with lovastatin alone [1]. Statins are a class of drugs commonly prescribed to decrease cholesterol levels and have recently been shown to also stimulate bone formation. The HPLC and UPLC methods were developed for the quantitative determination of lovastatin in red yeast rice extracts and dietary supplements that claim to contain red yeast rice. The separation was achieved by using C-18 column material, a water/acetonitrile mobile phase, both containing acid gradient system and a temperature of 35 °C. The method was validated for linearity, repeatability, limits of detection (LOD) and limits of quantification (LOQ). The LOD and LOQ of lovastatin were found to be 10 & 50 ng/mL by UPLC-UV method and 100 & 250 ng/mL by HPLC-UV method, respectively. The wavelength used for quantification with the diode array detector was 238 nm. The analysis of commercial products showed considerable variation of 0.37–5.65 µg of lovastatin/g of red yeast extract. LC-mass spectrometry coupled with electrospray ionization (ESI) interface method is described for the identification of lovastatin in red yeast rice samples. This method involved the use of $[M+H]^+$ ions ($m/z = 405.2641$) in the positive ion mode with extractive ion monitoring (EIM). **Acknowledgements:** This research is funded in part by "Science Based Authentication of Dietary Supplements" Funded by the Food and Drug Administration grant number 2 U01 FD 002071-07. **References:** [1] Lu Z, et al. (2008), *Am J Cardiol*, 101(12): 1689–1693.

P-73

Quantitative Determination of Chemical Constituents from Seeds of *Nigella sativa* L. by using HPLC-UV and Identification by LC-ESI-TOF

Avula B¹, Wang YH¹, Ali Z¹, Smillie TJ¹, Khan IA^{1,2}

¹ National Center for Natural Products Research, Research Institute of Pharmaceutical Sciences,

² Department of Pharmacognosy, School of Pharmacy, The University of Mississippi, MS 38677, USA

Nigella sativa Linn. belongs to the Ranunculaceae family and is an indigenous herbaceous plant that is more commonly known as the fennel flower plant. The plant is also known as black cumin (English) and black-caraway (USA). The spicy seeds from this plant have medicinal usage dating back to the ancient Egyptians, Greeks and Romans. In Egypt and the Middle East the black seed oil is popularly used for certain cases of chronic cough and bronchial asthma [1,2]. An HPLC method was developed for the simultaneous determination of nine compounds of *Nigella sativa* L. The separation was achieved within 23 minutes by using C-18 column material, a water/acetonitrile mobile phase, both containing 0.1% acetic acid gradient system and a temperature of 35 °C. The method was validated for linearity, repeatability, limits of detection (LOD) and limits of quantification (LOQ). The LOD and LOQ of nine compounds were found to be in the range from 0.09–10 µg/mL and 0.3–25 µg/mL, respectively. The wavelength used for quantification with the diode array detector was 205 and 260 nm. The seeds of *N. sativa* and commercial products showed the presence of all nine compounds. LC-mass spectrometry coupled with electrospray ionization (ESI) interface method is described for the identification of compounds in *Nigella sativa* L. samples. This method involved the use of $[M+H]^+$ and $[M+Na]^+$ ions in the positive ion mode with extractive ion monitoring (EIM). **Acknowledgements:** This research is funded in part by "Science Based Authentication of Dietary Supplements" Funded by the Food and Drug Administration grant number

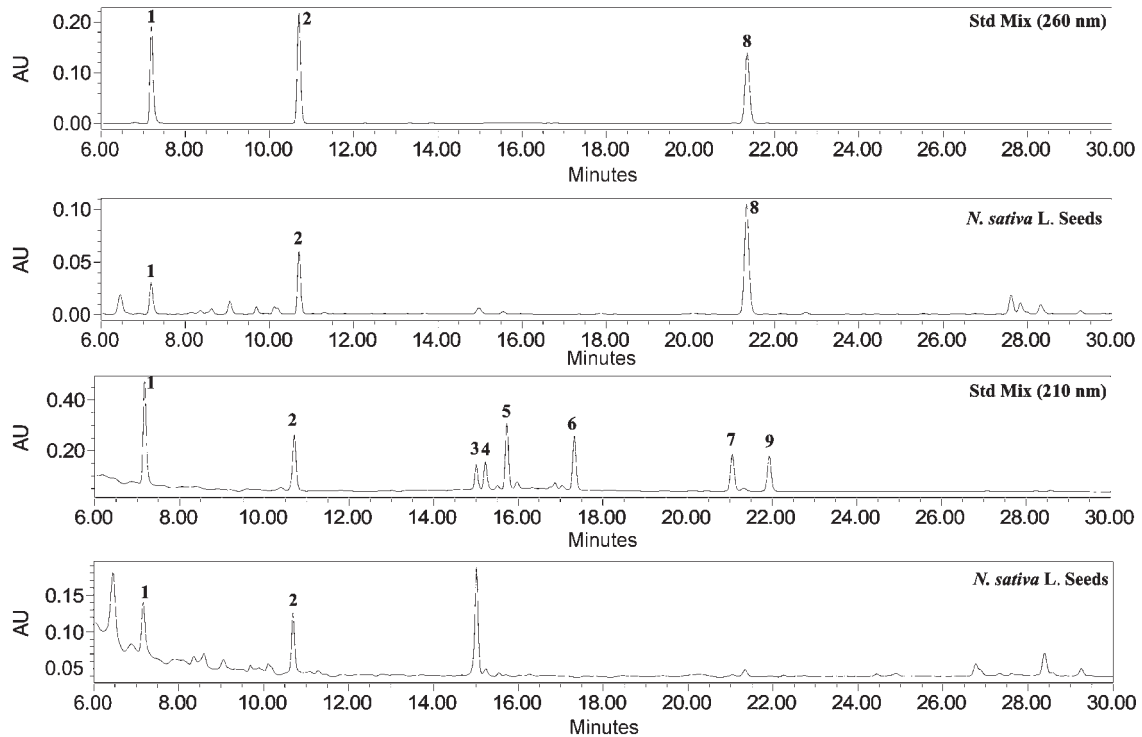

Fig. 1 HPLC chromatograms of standard mix, plant sample and dietary supplement at 260 nm (1) magnoflorine, (2) Kaempferol-3-O- β -glucopyranosyl (1 \rightarrow 2)-O- β -galactopyranosyl (1 \rightarrow 2)-O-glucopyranoside, (3) sieboldianoside A, (4) tauroside H2, (5) tauroside G3, (6) decaoside D, (7) sapindoside B, (8) thymoquinone, (9) tauroside E.

2 U01 FD 002071-07. **References:** [1] Zawahry MR, (1963), Kongr Pharm Wiss Vortr Origenatitt, 23: 193–203. [2] Khan A, (1999), Inflammopharmacology, 7(1): 15–35.

P-74

Characterization and Screening of Cycloartane and Flavonoid Glycosides from Stem-Leaves of *Sutherlandia frutescens* by Using HPLC-UV-ESI-MS and MS-MS Fingerprint Analysis

Avula B¹, Wang YH¹, Smillie TJ¹, Fu X¹, Li XC¹, Mabusele W², Syce J³, Johnson Q³, Folk W⁴, Khan IA^{1,2}

¹ National Center for Natural Products Research, Research Institute of Pharmaceutical Sciences,

² Department of Pharmacognosy, School of Pharmacy, The University of Mississippi, MS 38677, USA

³ University of the Western Cape, Bellville, South Africa 7535

⁴ University of Missouri-Columbia, Columbia, MO 65211-7020

Sutherlandia frutescens (L.) R. BR. (Family Fabaceae) is a widely used medicinal plant from South Africa. It is traditionally used for stomach problems, internal cancers, diabetes, inflammatory conditions and recently to improve the overall health in cancer and HIV/AIDS patients [1, 2]. LC-ESI-MSD-TOF and ESI-MS-MS analysis were performed on cycloartane and flavonoid glycosides employing two mass spectrometers equipped with ion-trap and TOF analyzers. The data illustrates the ability of the ESI techniques in the identification of cycloartane and flavonoid glycosides, including the nature of parent compound, the number of sugar residues and the type of saccharide moiety. The preliminary analytical results showed that numerous compounds have not been investigated yet. Additionally, screening and structural characterization offered more information about the chemical constitutions of *Sutherlandia frutescens*. About 55 compounds were screened using the ESI-TOF method, the major base peak ions generated by cycloartane glycosides are m/z 435, 437, and 439 $[M+H-sugar-3 H_2O]^+$ and flavonoid glycosides at m/z 287, and 303, respectively. Sutherlandioside B was found to be the major compound among the analyzed glycosides. Fragments de-

tected in the LC-ESI-TOF spectra of plant sample of *S. frutescens* and the dietary supplement are m/z 653.42 $[M+H]^+$, 491.37 $[M+H-sugar]^+$, 473.36 $[M+H-sugar-H_2O]^+$, 455.35 $[M+H-sugar-2 H_2O]^+$, 437.34 $[M+H-sugar-3 H_2O]^+$. In the MS-MS spectra, fragmentation reactions of the $[M+Na]^+$ were recorded to provide structural information about the glycosyl and aglycone moieties.

Acknowledgements: This research is funded in part by “Science Based Authentication of Dietary Supplements” Funded by the Food and Drug Administration grant number 2 U01 FD 002071-07 and “The International Center for Indigenous Phytotherapy Studies” funded by NCCAM, grant number 5 U19 AT 003264. **References:** [1] Stander BA, et al., (2007), Journal of Ethnopharmacology, 112 (2): 312–318. [2] Mils E, et al. (2005), Nutrition Journal, 4: 19.

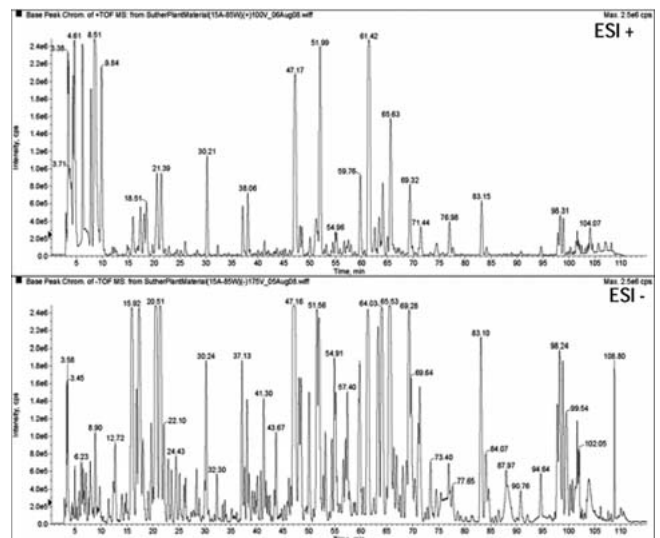

Fig. 1 TIC of cycloartane and flavonoid glycosides from stem-leaves of *Sutherlandia frutescens* by using HPLC-ESI-MSD-TOF.

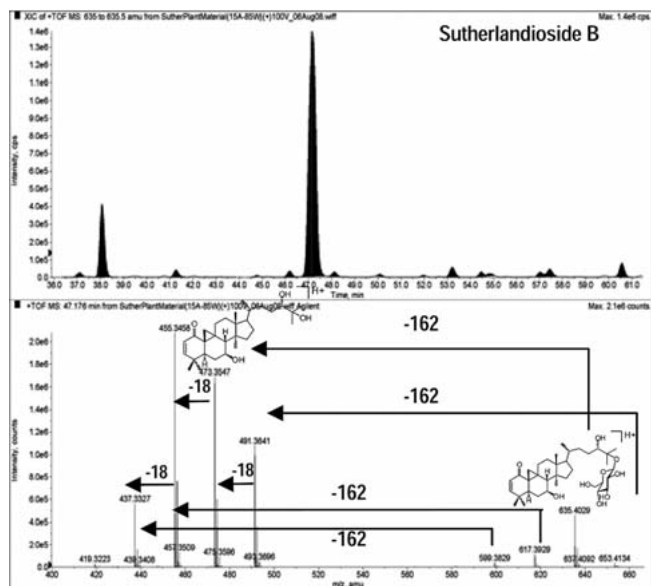

Fig. 2 MS spectrum of Sutherlandioside B (peak 31 in Fig. 1). Inset is the structure and its MS fragment pathway.

P-75

Quantitative Determination of Cycloartane and Flavonoid Glycosides from *Sutherlandia frutescens* by UPLC-UV, UPLC-ELSD Methods and Confirmation by UPLC-MS

Avula B¹, Wang YH¹, Smillie TJ¹, Fu X¹, Li XC¹, Mabusela W³, Syce J³, Johnson Q³, Folk W⁴, Khan IA^{1,2}

¹ National Center for Natural Products Research, Research Institute of Pharmaceutical Sciences,

² Department of Pharmacognosy, School of Pharmacy, The University of Mississippi, MS 38677, USA

³ University of the Western Cape, Bellville, South Africa 7535.

⁴ University of Missouri-Columbia, Columbia, MO 65211-7020

Sutherlandia frutescens (L.) R. BR., Family Fabaceae, is a well-known and widely used medicinal plant from the Western Cape, South Africa [1,2]. Traditionally it has been used as a remedy for stomach problems, internal cancers, diabetes and various inflammatory conditions. Recently, it has been used for the management of HIV/AIDS in patients [1]. This paper describes the analytical method suitable for the determination of four flavonoid glycosides (Sutherlandin A, B, C, D) and four cycloartane glycosides (Sutherlandioside A, B, C, D) from stem-leaves of *Sutherlandia frutescens* (L.) R. BR. A separation by UPLC was achieved by using Acquity shield RP18 column, PDA with ELS detection, and a water/acetonitrile gradient as the mobile phase. The major cycloartane glycoside compound (sutherlandioside B) was detected at a concentration as low as 1.0 µg/mL. The analysis of plant material and products showed considerable variation of 0.6–2.7% for the major compound. This method involved the use of the [M+H]⁺ and [M+Na]⁺ ions in the positive ion mode with extractive ion monitoring (EIM). The eight compounds were further confirmed by UPLC-MS method in plant sample and products. In the positive ion mode, the protonated species [M+H]⁺ at *m/z* 741.2, 741.2, 725.2, 725.2, 653.4, 651.4, 635.4 and 653.4 and sodiated species [M+Na]⁺ at *m/z* 763.2, 763.2, 747.2, 747.2,

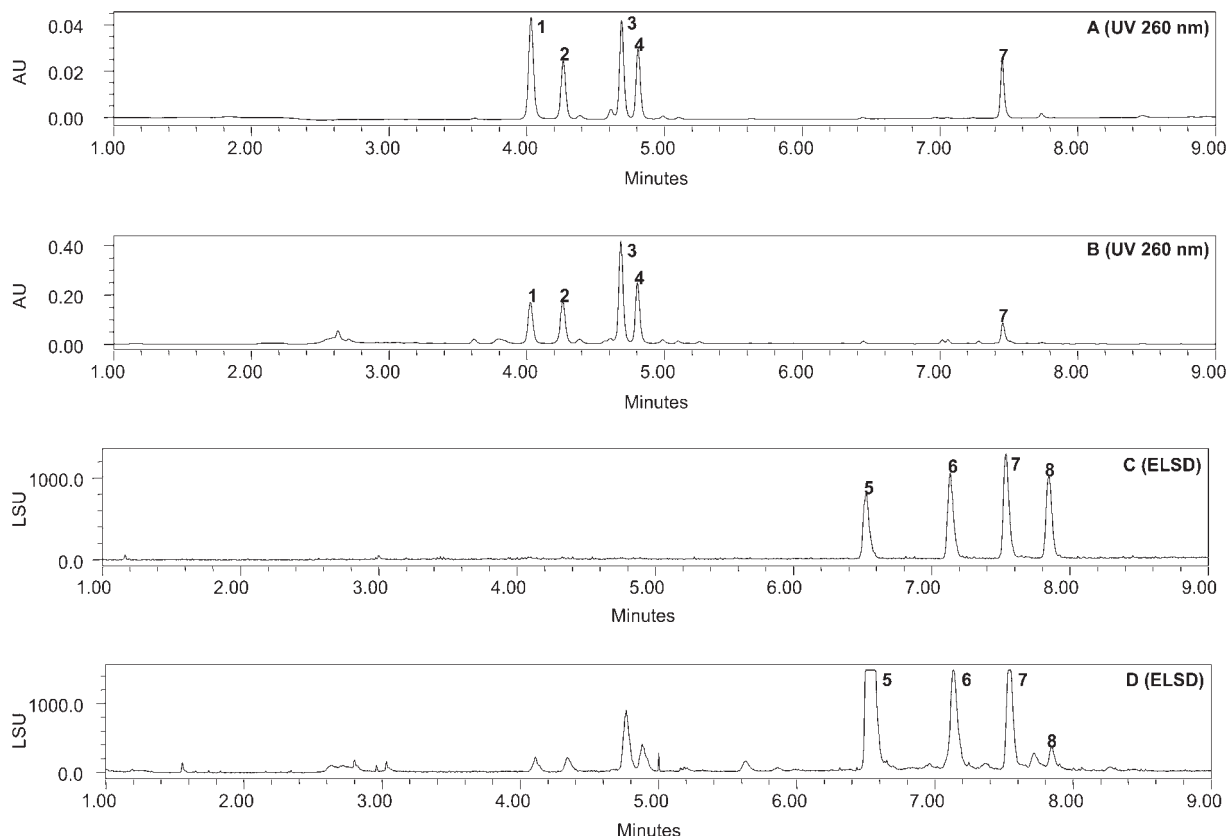

Fig. 1 UPLC chromatograms of a mixture of standard [Sutherlandin A (1), Sutherlandin B (2), Sutherlandin C (3), Sutherlandin D (4), Sutherlandioside B (5) Sutherlandioside C (6), Sutherlandioside D (7), Sutherlandioside A (8)] (A, C), leaves of *Sutherlandia frutescens* (B, D) by ELSD and UV detection at 260 nm.

675.4, 673.4, 657.4 and 675.4 for compounds 1–8 were observed. **Acknowledgements:** This research is funded in part by “Science Based Authentication of Dietary Supplements” Funded by the Food and Drug Administration grant number 2 U01 FD 002071-07 and “The International Center for Indigenous Phytotherapy Studies” funded by NCCAM, grant number 5 U19 AT 003264. **References:** [1] Stander BA, et al. (2007), *Journal of Ethnopharmacology*, 112 (2): 312–318. [2] Mils E, et al. (2005), *Nutrition Journal*, 4: 19.

P-76

Quantitative Determination of β -Arbutin and Seven Flavonoids from *Turnera diffusa* (Damiana) Extracts and Dietary Supplements Claiming to Contain Damiana by Using HPLC-UV Method

Wang YH¹, Avula B¹, Smillie TJ¹, Khan IA^{1,2}

¹ National Center for Natural Products Research, Research Institute of Pharmaceutical Sciences,

² Department of Pharmacognosy, School of Pharmacy, The University of Mississippi, MS 38677, USA

Turnera diffusa Willd (Turneraceae), common name damiana, is an aromatic shrub with small yellow flowers. The leaves and sometimes the stems of damiana have medicinal uses. Evaluation of herbal dietary supplements marketed on the internet for recreational use shows that 10% of the most common products were claiming to contain damiana in the product ingredients [1,2]. An HPLC/UV method permitting the simultaneous determination of 8 compounds isolated from *T. diffusa* has been developed. A separation was achieved within 45 minutes by using the C-18 material column. The mobile phase was comprised of acetonitrile/methanol (90:10, v/v) containing 0.1% acetic acid and 50 mM ammonium acetate (pH=4.2) at a flow rate of 1 mL/min and the column temperature was maintained at 30°C. The method was validated for linearity, repeatability, limits of detection (LOD) and limits of quantification (LOQ). The developed method was applied for the quantitative determination of eight compounds [β -Arbutin (1), apigenin 7-O- β -D-glucoside (2), triclin 7-O- β -D-glucoside (3), turneradiffusin (4), diffusavone (5), turneradin (6), apigenin 7-O- β -D-(5-O- β -coumaroyl)-glucoside (7) and echinactin (8)] for two different species of *Turnera* and dietary supplements. The eight compounds in two different species of *Turnera* and dietary supplements were further confirmed by LC-ESI/MS. **Acknowledgements:** This research is funded in part by “Science Based Authentication of Dietary Supplements” Funded by the Food and Drug Administration grant number 2 U01 FD 002071-07. The authors would like to thank Annette Ford, University of Mississippi for extraction of samples. **References:** [1] Wiggins IL, (1980), *Flora of Baja California*, Stanford University

Press, p.817. [2] Dermely CE, et al. (2005) *The Ann. of Pharmacotherapy*, 39: 1634–1639.

P-77

Quantitative Determination of Fucoxanthin from Brown Algae Extracts and Dietary Supplements by Using HPLC-UV and UPLC-UV-MS Methods

Wang YH¹, Avula B¹, Smillie TJ¹, Khan IA^{1,2}

¹ National Center for Natural Products Research, Research Institute of Pharmaceutical Sciences,

² Department of Pharmacognosy, School of Pharmacy, The University of Mississippi, MS 38677, USA

Fucoxanthin is a characteristic carotenoid of brown sea weeds, such as *Undaria pinnatifida*, *Hijikia fusiformis*, and *Sargassum fulvellum*. It has a unique structure including an allenic bond and 5, 6-mono-epoxide in the molecule. Fucoxanthin shows anti-obesity, anti-carcinogenic, anti-inflammatory and radical scavenging effects [1]. HPLC and UPLC methods have been developed for the quantitative determination of fucoxanthin in extracts and dietary supplements. The separation was achieved by using C-18 column material in both HPLC and UPLC method using a water/acetonitrile mobile phase. For the HPLC method, both solvents contain 0.1% acetic acid and in the UPLC method, both solvents contain 0.05% formic acid. The column temperatures were maintained at room temperature and 35°C for HPLC and UPLC methods, respectively. The methods were validated for linearity, repeatability, limits of detection (LOD) and limits of quantification (LOQ). The LOD and LOQ of fucoxanthin was found to be 50 & 150 ng/mL, 10 & 35 ng/mL and 1 & 3 ng/mL by using HPLC-UV, UPLC-UV and UPLC-MS methods, respectively. The wavelength used for quantification with the diode array detector was 449 nm and m/z at 659.4 [M+H]⁺. LC-mass spectrometry coupled with electrospray ionization (ESI) interface method is described for the identification of compounds in extracts containing fucoxanthin and dietary supplements. This method involved the use of [M+H]⁺ ions in the positive ion mode with single ion recording (SIR). **Acknowledgements:** This research is funded in part by “Science Based Authentication of Dietary Supplements” Funded by the Food and Drug Administration grant number 2 U01 FD 002071-07. The authors would like to thank Annette Ford, University of Mississippi for extraction of samples. **References:** [1] Hayato M, et al. (2007), *Journal of Oleo Science*, 56: 615–621.

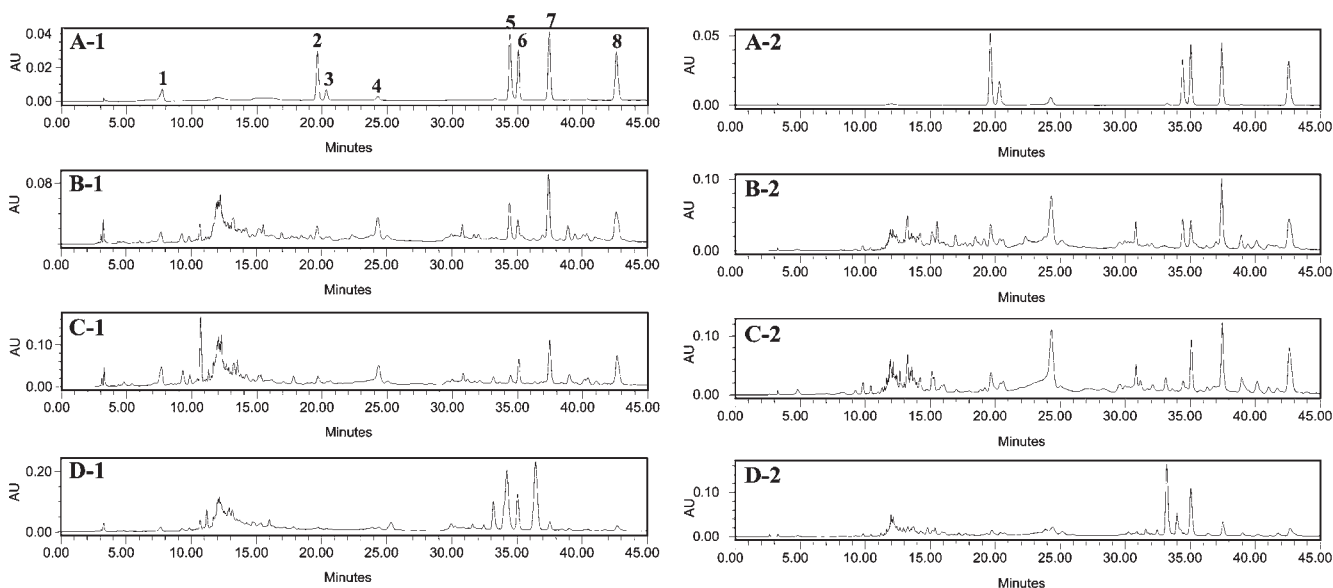

Fig. 1 HPLC-UV chromatograms of a standard mix. (A), extracts of *T. diffusa*. (B) and dietary supplements (C–D) at wavelength 280 nm (1) and 345 nm (2).

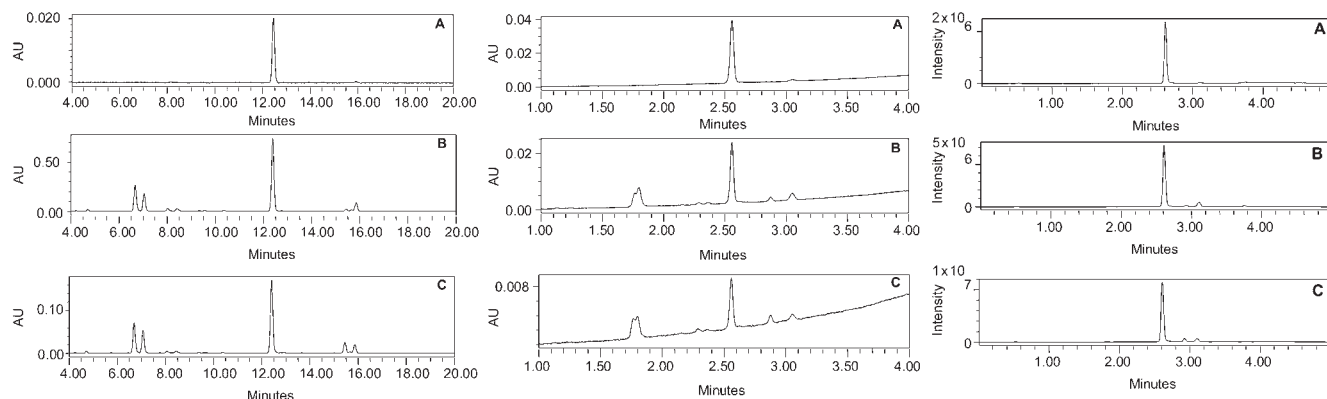

Fig. 1 HPLC-UV, UPLC-UV and UPLC-MS chromatograms of fucoxanthin standard (A), and extracts (B–C) at 449 nm.

P-78

ESI-MSⁿ as a Tool to Characterize Isoquinoline Alkaloids and Identify Possible Adulterant from Dietary Supplements that Claimed to Contain Goldenseal

Wang YH¹, Avula B¹, Smillie TJ¹, Khan IA^{1,2}

¹ National Center for Natural Products Research, Research Institute of Pharmaceutical Sciences,

² Department of Pharmacognosy, School of Pharmacy, The University of Mississippi, MS 38677, USA

Hydrastis canadensis L., commonly known as goldenseal, is a perennial herb in the buttercup family Ranunculaceae, native to southeastern Canada and the northeastern US, and an economically important North American medicinal plant that has been subject to adulteration in commerce. The phytochemicals of interest in goldenseal are the isoquinoline alkaloids hydrastine, berberine, and canadine. Other compounds of interest are palmatine, coptisine and jatrorrhizine, alkaloids that are found in potential adulterant species but not in goldenseal [1–2]. Isoquinoline alkaloids β -hydrastine, hydrastinine, canadine, berberine, coptisine, jatrorrhizine and palmatine have been characterized by using electrospray ionization multi-stage tandem mass spectrometry (ESI-MSⁿ) coupled with an ion-trap analyzer. Fragments C₁₁H₁₂NO₂⁺ are dominant or

major products ions in hydrastinine and β -hydrastine, respectively. The C-ring is relative weak and likely broken in tetrahydroisoquinoline alkaloid canadine. In ESI source, the product ions of canadine are found at m/z 176 corresponding to fragments C₁₀H₁₀NO₂⁺. This fragment bears the core skeleton of dominant ions in hydrastinine. However, for highly unsaturated isoquinoline alkaloids, its skeleton is relatively stable. In this sub-group, the major ions, such as presenting ions at m/z 308, 294 and 292 in palmatine, jatrorrhizine and beberine respectively, may involve the re-arrangement of D-ring. The results of the current study have classified the fragmentation pathway of each sub-group into isoquinoline alkaloids. It can be used to characterize the structures of trace isoquinoline alkaloids in dietary supplements that claimed to contain goldenseal, and will benefit to identify adulterant in dietary supplements. **Acknowledgements:** This research is funded in part by "Science Based Authentication of Dietary Supplements" Funded by the Food and Drug Administration grant number 2 U01 FD 002071-07. **References:** [1] Weber HA, et al. (2003), J Agric Food Chem, 51: 7352–7358. [2] Brown PN, et al. (2008) Pharm Biol, 46: 135–144.

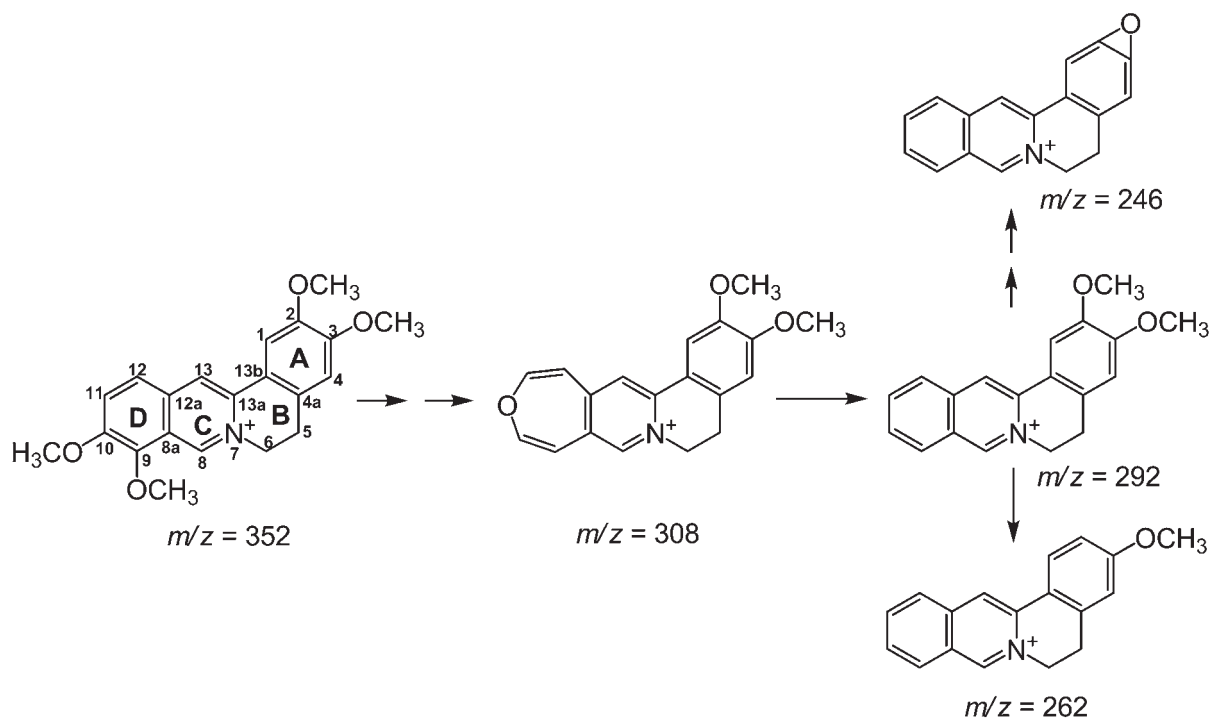

Fig. 1 Fragmentation Pattern Proposed for M⁺ Ions of Palmatine.

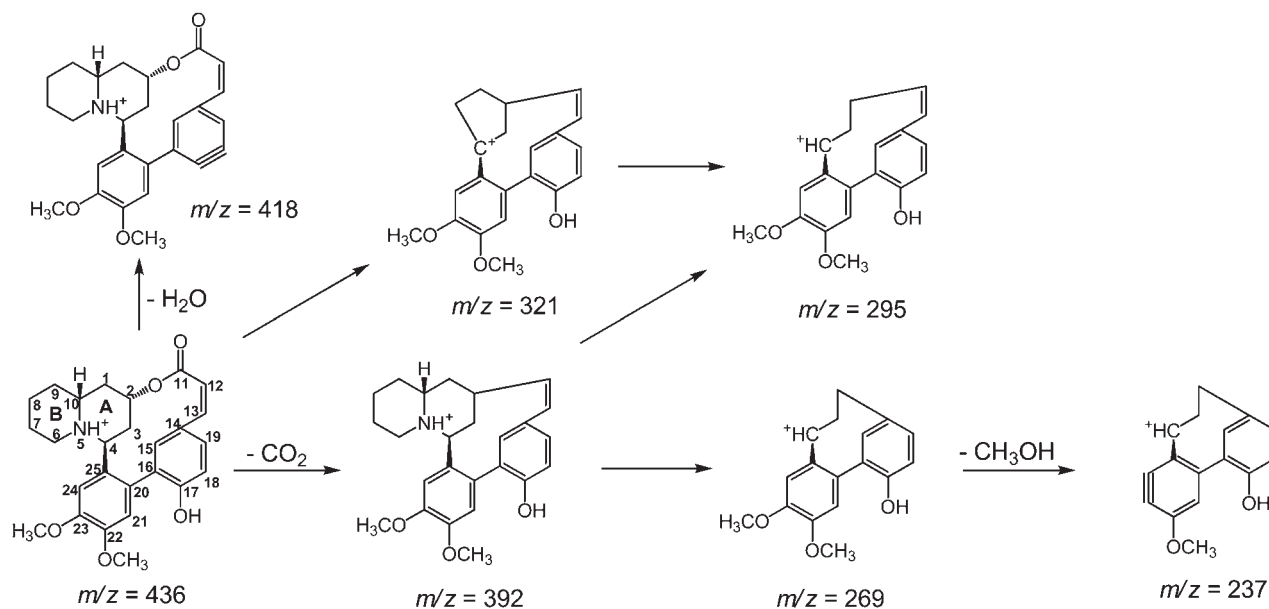

Fig. 1 Fragmentation pattern proposed for $[M+H]^+$ ions of vertine.

P-79

Structural Characterization of Quinolizidine Alkaloids in *Heimia salicifolia* by Electrospray Ionization Tandem Mass Spectrometry

Wang YH¹, Avula B¹, Rumalla CS¹, Smillie TJ¹, Khan IA^{1,2}

¹ National Center for Natural Products Research, Research Institute of Pharmaceutical Sciences,

² Department of Pharmacognosy, School of Pharmacy, The University of Mississippi, MS 38677, USA

Heimia salicifolia (Lythraceae), also known as sun opener or shrubby yellow crest, is a wild flowering shrub distributed from Mexico, southwestern Texas to northern Argentina. It has been used as antipyretic, emetic, laxative, diuretic and anti-inflammatory and for its wound healing activity in Central and South America. The folkloric reports claimed the plant had psychotomimetic activity [1]. Nine quinolizidine alkaloids and biphenyl quinolizidine lactone alkaloids isolated from *H. salicifolia* have been structurally characterized by using electrospray ionization multi-stage tandem mass spectrometry (ESI-MSⁿ) coupled with an ion-trap analyzer. The fragmentation patterns of these alkaloids are dominated by the existence of bridge between C-2 and C-4, and less affected in accordance with structural variations of substitution at C-2 and C-12. When forming the lactone bridge between C-2 and C-4 over a biphenyl moiety, a neutral loss of 44 Da corresponding to carbon dioxide is easily generated. Moreover, the product ions will further yield fragment ions related to the cleavage of A-ring at C-1/C-2 and C-4/C-5. B ring bearing nitrogen atom has been found as one very easily loss group in the fragmentation pathways of all analyzed quinolizidine alkaloids. The results of this study can benefit the determination of trace quinolizidine alkaloids and biphenyl quinolizidine lactone alkaloids in crude plant extract and also provide background information to aid the structural investigations of related biological studies and forensic science. **Acknowledgements:** This research is funded in part by "Science Based Authentication of Dietary Supplements" Funded by the Food and Drug Administration grant number 2 U01 FD 002071-07. **References:** [1] Malone MH, et al. (1994), *J Ethnopharm*, 42: 135–159.

P-80

Quantitative Determination of Galactolipids from *Lycium barbarum* L. by SPE Assisted HPLC-ELSD Method and Structural Characterization by ESI-MS/MS

Wang YH¹, Avula B¹, Gao ZP¹, Ali Z¹, Smillie TJ¹, Khan IA^{1,2}

¹ National Center for Natural Products Research, Research Institute of Pharmaceutical Sciences,

² Department of Pharmacognosy, School of Pharmacy, The University of Mississippi, MS 38677, USA

Lipids are important constituents of all living organisms. Galactolipids are a class of acylated membrane lipids with a sugar molecule attached to the third carbon of the glycerol molecule. These compounds are associated primarily with plastid membranes in seed plants [1]. The fruit of *Lycium barbarum* L. has been widely used in the health food industry because of its possible role in the prevention of chronic disease like age-related macular degeneration. In addition, it may possess antioxidant and antitumor activities, neuroprotective effect, and enhance immunity [2]. An SPE assisted HPLC/ELSD method has been developed for the quantitative determination of galactolipids from *Lycium barbarum* L. fruits. The separation of six galactolipids and one steroid were achieved by using C-18 column material in HPLC method coupled with an ELS detector. A water/acetonitrile mobile phase, both containing 0.1% acetic acid, was selected for the outlined method. The column temperature was maintained at 25 °C. The method was validated for logarithmic linearity, repeatability, limits of detection (LOD) and limits of quantification (LOQ). The LOD and LOQ of galactolipids were found to be in the range from 10–20 µg/mL and 20–50 µg/mL, respectively. The structures of six galactolipids and one steroid were further characterized by ESI-MS/MS method. Ion-trap tandem mass spectrometry coupled with electrospray ionization (ESI) interface method is described for the identification of compounds in *L. barbarum*. The developed HPLC-ELSD method has been successfully applied for determination of target analytes in different populations of same species. **Acknowledgements:** This research is funded in part by "Science Based Authentication of Dietary Supplements" Funded by the Food and Drug Administration grant number 2 U01 FD 002071-07. **References:** [1] Guella G, et al. (2003), *Rapid Commun Mass Spectrom*, 17: 1982–1994. [2] Inbaraj BS, et al. (2008) *J Pharm Biomed Anal*, 47: 812–818.

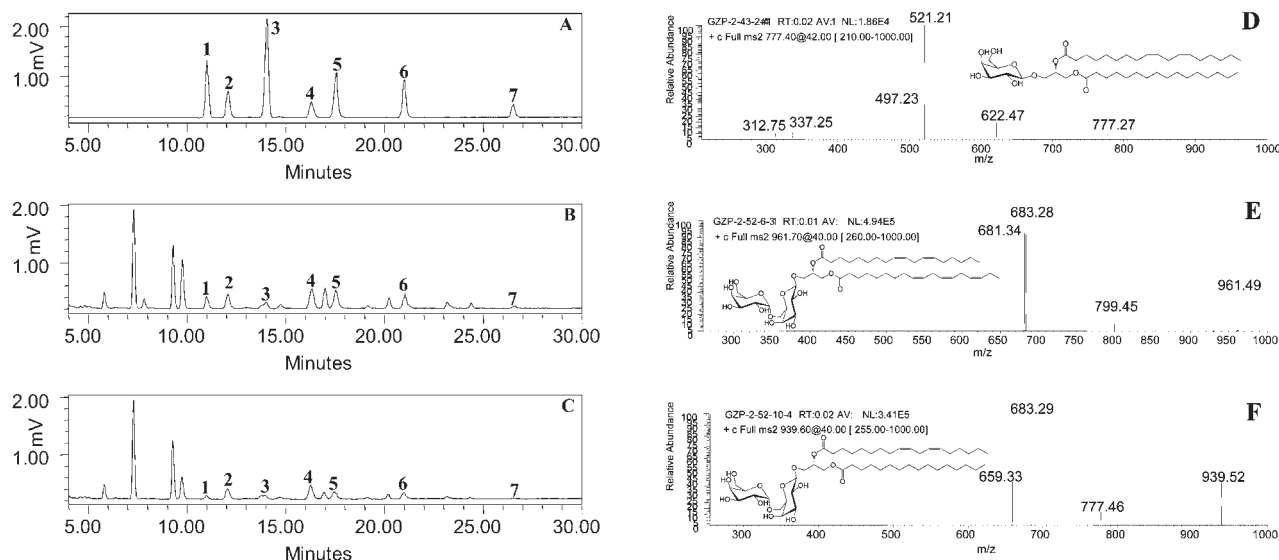

Fig. 1 HPLC-ELSD chromatograms of standards (A) and extracts of *L. barbarum* L. (B–C), and typical ESI-MS/MS spectra of analytes (D–F).

P-81

Isolation and Qualitative Characterization of Antidepressant Marsiline by Liquid Chromatography Tandem Mass Spectrometry [LC-MS/MS] from *Marsilea quadrifolia* L.

Mondal AK¹, Sarkar AK², Pal TK², Das N¹, Mondal (Parui) S³

¹ Department of Botany and Forestry, Plant Taxonomy, Biosystematics and Molecular Taxonomy Laboratory, Vidyasagar University, Midnapore-721 102, West Bengal, India

² Department of Pharmaceutical Technology, Jadavpur University, Kolkata-700 037, West Bengal, India

³ Department of Zoology, Lady Brabourne College, Kolkata-700 017, West Bengal, India

Anxiety, depression and mental health problems constitute the second most common chronic condition in clinical practice. Various

types of herbal medicines are being used as anxiolytic drugs, which necessitates the development of newer and more effective antidepressants from traditional medicinal plants whose psychotherapeutic potential needs to be assessed in a variety of animal models [1, 2]. The main objective of this work was to develop a simple, sensitive, rapid and reliable liquid chromatography-tandem mass spectrometry (LC-MS/MS) method for the simultaneous identification of Marsiline (Fig. 1), a major central nervous system active principal, that has been found to be responsible for sedative and anticonvulsant activity in *Marsilea* sp. (1, 2). The LC-MS/MS system (API 2000) with triple quadrupole tandem mass spectrometer (AB Sciex Instruments, Foster, Canada) was used for qualitative determination of Marsiline from methanolic extract. The most active ingredient Marsiline was extracted by simple liquid-liquid extraction with organic solvent (benzene: n-hexane 1: 1 v/v). The protonated analyte was

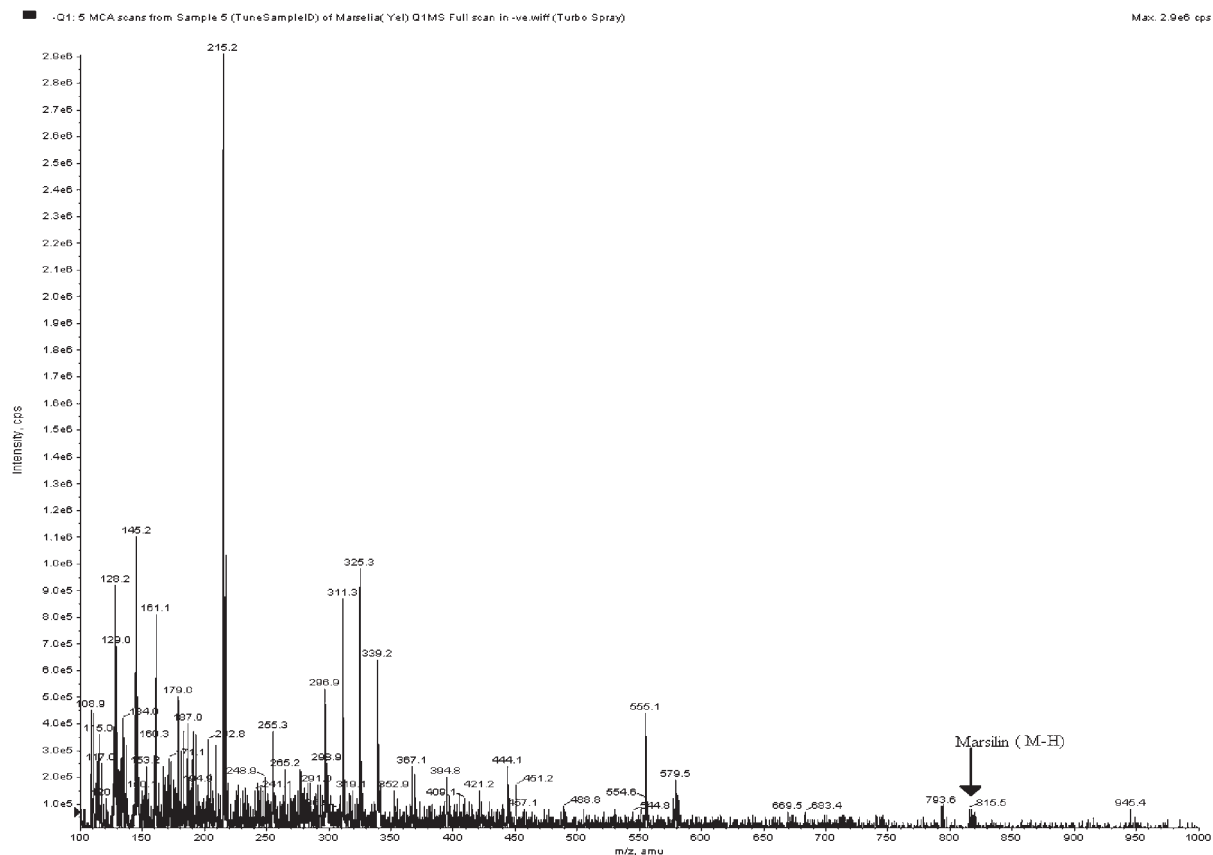

quantitated by positive ionization in multiple reactions monitoring with a mass spectrometer. The MRM transition of 815–225 m/z was used to measure Marsiline. Data acquisition was performed with Analyst 1.4.1. software. This method will be further applied to quantify Marsiline content from other *Marselia* sp. **Acknowledgements:** The authors are indebted to the University Grants Commission (UGC), New Delhi, India for their financial support in the form a Major Research Project. We express our thanks and gratitude to Bioequivalence Study Centre, Jadavpur University, Kolkata-700 032, West Bengal, India for providing us the necessary instrumental facility (LC-ESI-MS/MS). **References:** [1] Bhattamisra SK, et al. (2007) Journal of Herbal Medicine and Toxicology, 1(1): 15–20. [2] Chatterjee A, et al. (1963) Journal of Experimental Medical Sciences, 7: 53–67.

P-82

In Vivo and In Vitro Evidence for Genotoxicity of Acrylamide

McGee HR³, Hegazi EA¹, Madkour SA¹, Osman M², Saunders JA³

¹ Departments of Forensic Medicine and Toxicology, Egypt

² Faculty of Medicine, Alexandria University and Genetic Engineering Institute, Menoufiya University

³ Egypt Molecular Biology, Biochemistry & Bioinformatics, Towson University, Towson, MD 21252, USA

Acrylamide is a chemical intermediate used in a variety of laboratory and commercial products including soil-conditioning agents, dyes, pigments, and in the treatment of drinking water. Acrylamide also finds its way into the human diet when amino acids and sugars present in food are heated at high temperature during food processing. Earlier studies have demonstrated that chronic acrylamide treatment produced tumors in rats and mice; yet, the mechanism of acrylamide carcinogenicity remains unresolved. The aim of the present study was to investigate the biologic consequences of acrylamide exposure both *in vitro* and *in vivo* animal models. Animals were subjected to bone marrow micronucleus assays, chromosomal analysis, and flow cytometry analysis. Significant increases of chromosomal aberrations, in a dose dependent manner, were observed in human leukocytic culture and bone marrow cells of mice. There was also an increase in micronucleus frequency in bone marrow cells of mice. Flow cytometry analysis showed a reduced DNA content in liver cells of treated mice indicating acrylamide clastogenicity. Although acrylamide is a common laboratory reagent, its role as an environment contaminants will only be resolved with further investigations of its detrimental effects.

P-83

Localization of NAD⁺ Synthesis Enzymes in the Pathogenic Yeast *Candida glabrata*

Addison A¹, Pan SJ², Cormack BP²

¹ Molecular Biology, Biochemistry, & Bioinformatics, Towson University, 8000 York Road, Towson, MD 21252

² Department of Molecular Biology and Genetics, Johns Hopkins Medical Institutes, Baltimore, MD 21205

Candida glabrata is an opportunistic yeast pathogen of humans and accounts for approximately 4% of all catheter associated urinary tract infection. It is normally controlled by the body's immune system and the body's bacteria flora, but can cause serious mucosal and systemic infections. *C. glabrata* is a nicotinamide adenine dinucleotide (NAD⁺) auxotroph, which depends on the environmental supply of NAD⁺ precursors using nicotinamide riboside (NR), nicotinic acid (NA), and nicotinamide (NAM) as NAD⁺ precursors. These precursors are used in a functional Preiss-Handler pathway to produce NAD⁺. We focused on the location of enzymes used in the Preiss-Handler pathway of *C. glabrata* under conditions replete for NAD⁺ precursors and under extreme conditions such as NAD⁺ precursor starvation. The C-terminus of the Npt1, Qns1, Nrk1 and Pnc1 was tagged with GFP to identify the location of the enzymes in the yeast before and after starvation of NA and NR. Under the fluorescent microscope, localization of enzymes was found in the cytoplasm before and after starvation. Therefore, within the limits of

our assay, we conclude that localization of the Preiss-Handler pathway enzymes in *C. glabrata* is unaffected by environmental conditions. We intend to confirm and extend these results by exploring the subcellular localization of pathway enzymes using different tags for localization.

P-84

Vaccine Created to Defend Against Staphylococcus aureus Biofilms in Cases of Severe Osteomyelitis

Newman LM¹, O'May GA², Shirtliff ME²

¹ Molecular Biology, Biochemistry & Bioinformatics, Towson University, Towson, MD 21252

² University of Maryland, Dental School, Baltimore, MD 21201

Methicillin-resistant Staphylococcus aureus (MRSA) is a bacterium that causes infections to be especially difficult to treat. *S. aureus* has become a particularly significant problem in hospitals, where they often grow as biofilms and are currently the largest contributor to nosocomial infections. In previous experimentation, multiple strains of immunogens were found to be upregulated in biofilm growth. In this experiment, the antigens to four of these immunogens were grown in culture and combined to create a vaccine. This vaccine was administered to New Zealand white rabbits that were later infected with *S. aureus* tibial osteomyelitis. The initial vaccine was given on day zero of the experiment. The rabbit titer was boosted with a second injection after ten days. The animals were challenged after ten days with MRSA introduced to the left tibia. Responses to vancomycin were evaluated by examining osteomyelitic infection in the rabbit tibias. The combination of vaccine and vancomycin treatment significantly lowered levels of biofilm infection. From these results, we postulate that the vaccine was able to prevent the formation of the biofilm and vancomycin was able to destroy the remaining bacteria. From the positive results of this experiment, we plan on expanding this study to mouse models.

P-85

Determining the Sensitivity of Gustatory Neurons in the Maxillary Styloconic Sensilla of Gypsy Moth Larvae

Srouf K¹, Martin T¹, Shields V²

¹ Molecular Biology, Biochemistry, and Bioinformatics,

² Department of Biological Sciences, Towson University, 8000 York Rd, Towson, MD 21252

Gypsy moth larvae, *Lymantria dispar* (L.), are highly polyphagous and display a wide host preference, feeding on the foliage of many species, but favoring leaves of deciduous hardwood trees, such as oak, maple, and sweet gum. Gypsy moth larvae are major pest defoliators in the United States and destroy millions of acres of trees annually. These lepidopteran insects possess gustatory sensory organs located on the maxillae, namely the medial and lateral galeal styloconic sensilla, which play an important role in host-plant selection. Using a single cell electrophysiological recording method, this study characterized the sensitivity of the receptor cells housed within each sensillum of gypsy moth larvae when exposed to a panel of selected phytochemicals by performing dose response experiments. Electrophysiological tip recordings from these sensilla revealed that medial styloconic sensilla responded to the alkaloids, strychnine and atropine, while lateral styloconic sensilla responded to aristolochic acid and atropine. In general, these different taste cells exhibited characteristic temporal firing patterns. Thus, this study provides correlative insights into the feeding behavior and taste physiology of this larval insect. It also provides a gateway to use other alkaloids in temporal and dose-response experiments as a possible means of biocontrol.

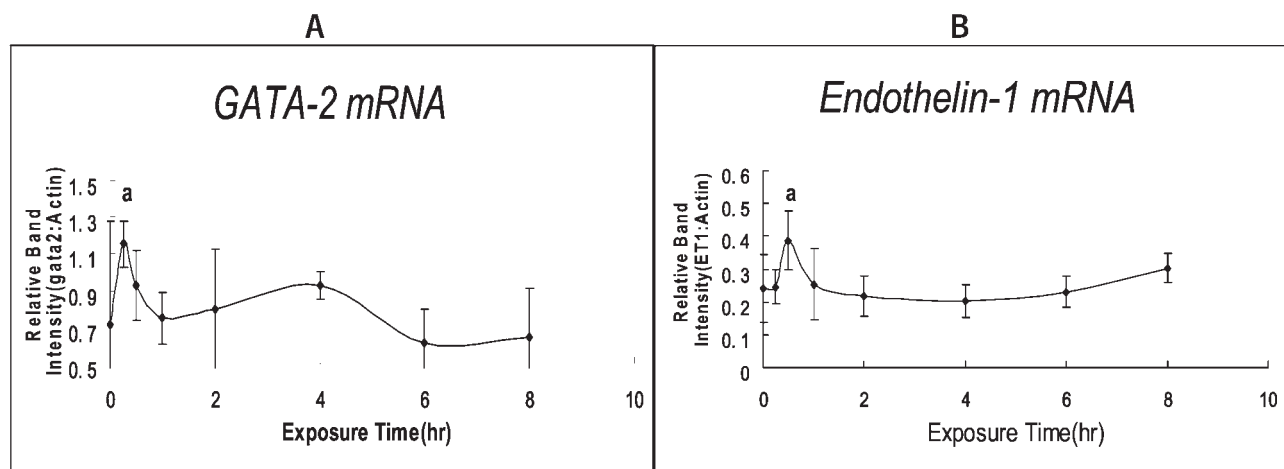

Fig. 1 Effect of BC on GATA2 (panel A) and endothelin-1 (panel B) mRNA expression in medaka embryo. Fertilized medaka eggs on 3-day post fertilization were exposed to 10 µg/ml BC for 0, 0.25, 0.5, 1, 2, 4, 6, and 8 h, and the extracted mRNA was used for semi-quantitative reverse transcriptase polymerase chain reaction (rt-PCR). Lowercase "a" indicates that the values are significantly different ($p < 0.05$, $n = 4$) after 0.25 h of BC treatment.

P-86

Carbohydrate Specificity of the Oyster (*Crassostrea virginica*) Galectin CvGal: Recombinant Expression and Characterization of Selected Carbohydrate Recognition Domains

Gomes E¹, Wendland T², Vasta G², Ahmed R²

¹ Towson University, Molecular Biology, Biochemistry and Bioinformatics, 8000 York Road, Towson, Maryland 21252

² Center of Marine Biotechnology, University of Maryland Biotechnology Institute, Columbus Center, Suite 236, 701 East Pratt Street, Baltimore, MD 21202

It is widely accepted that recognition of exposed glycans on the cell surface of potential pathogens by host humoral or cell-associated lectins is a key component of the innate immune response of vertebrates and invertebrates. However, the protozoan parasite *Perkinsus marinus* causes "Dermo" disease in the eastern oyster *Crassostrea virginica*, and is responsible for catastrophic damage to shellfisheries in North America. Until recently, the parasite's mechanism(s) for entry into the hemocyte had remained obscure. The recent results suggest identification and characterization in oyster hemocytes a galectin (CvGal) with a unique carbohydrate-recognition domain (CRD) organization that, unlike most mammalian galectins, recognizes exogenous carbohydrate ligands [1]. CvGal binds to a variety of potential microbial pathogens, phytoplankton components, and *Perkinus* trophozoites, suggesting that it functions as a hemocyte surface receptor for this parasite, and facilitates its entry into the host cells. Unlike all galectins known so far, CvGal displays four CRDs that contain seven of the nine amino acid residues that bind ligand in the bovine galectin-1. Because the CvGal CRDs are similar, but not identical to each other, their carbohydrate specificities may be also different. To characterize their carbohydrate specificity, we initiated the recombinant expression of the CvGal CRDs, individually and as combinations of 2 and 3 CRDs to enable the rigorous analysis of their binding specificity and affinity. We developed expression constructs into a pET expression vector for all four individual CRDs, as well as CRDs 2-3 and CRDs1-2-3. Expression, purification, and characterization of each recombinant CRD are underway. **Acknowledgements:** Thanks go to the Center of Marine Biotechnology, University of Maryland, and to Dr. Geraldo Vasta and Dr. Rifits Ahmed, and Tyson Wendland. (Supported by NSF Grant IOS-0822257 and NIH Grant RO1 GM070589-01 to G.R. V **Reference:** [1] Tasumi S, Vasta GR, (2007), J Immunol, 179: 3086–3098.

P-87

Teratogenic Effects of Blue Cohosh is Mediated through GATA2 Signaling Pathway

Wu M^{1,2}, Ali Z¹, Khan IA¹, Dasmahapatra AK^{1,2}

¹ National Center for Natural Product Research, Department of Pharmacology, Research Institute of Pharmacological Sciences, University of Mississippi, University, MS 38677

² Department of Pharmacology, School of Pharmacy, University of Mississippi, University, MS 38677

Blue cohosh (*Caulophyllum thalictroides*) (BC) is a perennial herb used by Native American Indian women to induce labor and for the treatment of other uterine complications. Several studies indicated that BC was not absolutely safe for the fetus and able to induce perinatal stroke and ischemia in newborn babies [1]. A recent chemical analysis identified 15 alkaloid-triterpene compounds present in BC [2] and some of them are potential teratogens. We used Japanese medaka (*Oryzias latipes*) embryo-larval development as our experimental model to verify the teratogenic potency of BC during embryogenesis. We observed that BC was able to induce cardiovascular defects in medaka embryo during development; however, total protein, RNA and several transcription factor mRNAs (*emx2*, *en2*, *iro3*, *otx2*, *shh1*, *wnt1* and *zic5*) which were expressed in central nervous system (CNS) of medaka embryo during embryogenesis remained unaltered. Further, we have used subtractive hybridization technique to identify BC-sensitive genes in medaka embryogenesis. We have observed that transcription factor GATA2 was over expressed by BC and *in situ* hybridization analysis indicated that GATA2 over expression was occurred in CNS. Analysis by semi-quantitative reverse transcriptase polymerase Chain reaction (rt-PCR) indicated that GATA2 mRNA expression was very rapid (significantly increased within 15 min of BC exposure). We predict that teratogenic effects of BC are due to over expression of GATA2 gene that can induce the expression of endothelin-1 mRNA in the cerebral microvessels and peripheral vessels, and thus cause dysfunction of cerebrovascular and cardiovascular system of Japanese Medaka during development.

P-88

Puerarin Attenuates Ethanol Toxicity in Medaka (*Oryzias Latipes*) Embryos During Development

Hu Y¹, Khan IA¹, Dasmahapatra AK^{1,2}

¹ National Center for Natural Product Research, Department of Pharmacology, Research Institute of Pharmacological Sciences, University of Mississippi, University, MS 38677

² Department of Pharmacology, School of Pharmacy, University of Mississippi, University, MS 38677

The drugs approved by FDA for the treatment of alcoholism are not recommended for the women in pregnancy [1]. Therefore, a drug

with anticraving property as well as non-toxic to fetus is required for the treatment of Fetal Alcohol Spectrum Disorder (FASD), a neurobehavioral disorder observed in the babies of alcoholic mothers who consumed alcohol during pregnancy. We have evaluated the potency of *Radix puerariae* (RP), the root extracts of a wild leguminous creeper kudzu (*Pueraria montana*), as an alternative natural medicine to prevent FASD using Japanese medaka (*Oryzias latipes*) embryo-larval development as the model. Previously, we have observed that ethanol was able to induce skeletal dysmorphogenesis in medaka by reducing skeletal growth in a dose-dependent manner [2]. In this experiment we have used RP and puerarin (Sigma-Aldrich) as preventive agents of ethanol-induced skeletal dysmorphogenesis in medaka. RP was collected from the Lafayette County of Oxford and HPLC analysis indicated that puerarin is the major isoflavone present in the methanolic extract of RP. Fertilized medaka eggs in standard laboratory conditions (16 L: 8D, 25 OC) were exposed to RP extract (0–1.5 mg/ml) for 6 day post fertilization (dpf) and then maintained in 48 well tissue culture plate in hatching solution (one embryo/ml/well). Embryo mortality was observed on 10 dpf. In separate experiments embryos were exposed to RP (0–0.5 mg/ml), Puerarin (0.25–1 mM) with or without ethanol (300 mM) for 2 dpf and then transferred to hatching solution. The calculated IC_{50} of RP as determined on 10 dpf is $785.3 \pm 2.66 \mu\text{g/ml}$ ($n=5$). Hatched embryos on 10 dpf were used for morphometric analysis of skeletal features including the skeleton, cranium, jaw, ethmoid and hypophyseal plate. It was observed that ethanol was able to reduce the growth of all these skeletal features, however, RP or puerarin alone has no effect. When the embryos were treated together with ethanol and RP or puerarin, ethanol-induced skeletal growth reductions were attenuated specifically by puerarin. It is therefore concluded that puerarin, the major flavonoid present in RP, has the potency to prevent ethanol-induced teratogenesis during development and can be used as an alternative natural medicine for the prevention of FASD or other alcohol related disorders. **Acknowledgements:** This work is supported in part by the United States Department of Agriculture, Agricultural Research Specific Cooperative Agreement No 586408-2-0009, National Center for Natural Product Research, School of Pharmacy, University of Mississippi, National Institute of Alcohol Abuse and Alcoholism (1R03 AA016915) and from The Center of Research Excellence in Natural products Neurosciences (P2ORR021929). **References:** [1] Williams SH, (2005), *Amm Fm Phys*, 72: 1775–1780. [2] Wang, et al. (2006), *Birth Def Res* 77B: 29–39.

P-89

Inhibition of Cytochrome P450 by Constituents from Blue Cohosh (*Caulophyllum thalictroides*)

*Madgula VLM*¹, *Ali Z*¹, *Smillie TJ*¹, *Khan IA*^{1,2}, *Walker LA*^{1,3}, *Khan SI*¹

¹ National Center for Natural Products Research,

² Department of Pharmacognosy,

³ Department of Pharmacology, School of Pharmacy, The University of Mississippi, University, MS 38677

Blue cohosh, *Caulophyllum thalictroides* is a popular herb that is extensively used for women's health. Alkaloids and saponins are considered to be responsible for its pharmacological effects. In this study the effects of methanolic extract of the roots of blue cohosh, alkaloidal fraction and isolated constituents on major drug metabolizing cytochrome P450 (CYP450) enzymes were evaluated. Methanolic extract did not show any effect but the alkaloidal fraction showed a strong inhibition of CYP 2C19, 3A4, 2D6, and 1A2 (> 80% inhibition at 100 $\mu\text{g/mL}$) with IC_{50} values in the range of 2–20 $\mu\text{g/mL}$. Among the constituents, caulophyllumine B (a piperidine type alkaloid), O-acetylbatifolin, anagyrine, and lupanine (lysine derived alkaloids) inhibited these enzymes to various extents (IC_{50} 2.5–50 μM). N-methylcytisine weakly inhibited CYP3A4 (32% inhibition at 100 μM). A more pronounced inhibitory effect on all the four enzymes was observed by an equimolar mixture of alkaloids. Among the saponins, caulosides C and D inhibited CYP3A4 at the highest test concentration of 100 μM (43% and 35% inhibition, respectively). Other enzymes were not affected. This in vitro study

indicates the possibility of drug-drug interactions. The dietary supplements containing blue cohosh may pose a risk if taken with other drugs or herbs, metabolism of which involves CYP450 enzymes. **Acknowledgements:** FDA grant no. FD-U-002071-07 and USDA, Agriculture Research Service Specific Cooperative Agreement no 58-6408-2-0009 are acknowledged for partial support of this work.

P-90

Preformulation Characterization of a Novel Delta-9-Tetrahydrocannabinol Amino Acid Prodrug

*Battu S*¹, *Rahman Z*¹, *Majumdar S*^{1,2}, *Gul W*^{2,3}, *ElSohly MA*^{2,3}, *Repka MA*^{1,2}

¹ Department of Pharmaceutics, School of Pharmacy, The University of Mississippi, MS, 38677

² The National Center for Natural Product Research, The University of Mississippi, MS, 38677

³ ElSohly Laboratories Inc., Oxford, MS, 38655

The current study evaluates the preformulation characteristics of THC-Serine, a novel prodrug of the poorly water soluble compound Delta-9-Tetrahydrocannabinol (THC). Aqueous solubility and stability and solubility in different surfactants and 2-hydroxypropyl- β -cyclodextrin (HP β CD) were studied. The LogP and pKa were calculated using computer modeling. Chemical, thermal and enzymatic stability of the prodrug was assessed at different pH (25 °C), elevated temperature (120 °C) and in human saliva, respectively. THC-Serine demonstrated pH dependent solubility. Highest solubility was observed at pH 2.0 (92-fold greater than THC). Solubility of the prodrug in Tween® 80 was 320-fold higher ($256.65 \pm 20.52 \mu\text{g/ml}$) than THC. With increasing concentrations of HP β CD solubility of THC-Serine was also observed to increase. Log P and pKa of THC-Serine were 3.18 and 7.05, respectively. Prodrug was most stable at pH 2.0, with a degradation rate constant of $3.17 \times 10^{-4} \text{h}^{-1}$. Almost 80% of the prodrug remained intact after heating at 120 °C for 8 minutes. The degradation rate constant in saliva was found to be $11.52 \times 10^{-2} \text{h}^{-1}$. The above results indicate that THC-Serine is a lead candidate for transmucosal THC delivery and warrants further investigation. **Acknowledgements:** This work was supported by Grant Number P2ORR021929 from the National Center for Research Resources (NIH/NCRR).

P-91

Preformulation Evaluation of Δ^9 -Tetrahydrocannabinol Prodrugs – a Tool for Establishing Physicochemical Characteristics of Compounds at an Early Stage

*Upadhye SB*¹, *Majumdar S*^{1,2}, *Gul W*^{2,3}, *ElSohly MA*^{2,3}, *Repka MA*^{1,2}

¹ Department of Pharmaceutics, School of Pharmacy, University of Mississippi, University, MS 38677

² National Center for Natural Products Research (NCNPR), School of Pharmacy, University of Mississippi, University, MS 38677

³ ElSohly Laboratories, Incorporated, 5 Industrial Park Drive, Oxford, Mississippi 38655, USA

Δ^9 -Tetrahydrocannabinol (THC, Fig. 1) is the primary active ingredient of the plant *Cannabis sativa* (marijuana) and is responsible for the majority of the pharmacological effects. While THC in marijuana is mainly known for its abuse potential, it also exhibits the therapeutic effects in the treatment of nausea and vomiting during cancer chemotherapy. The only dosage form currently approved by FDA is an oral, soft gelatin capsule (Marinol®). This dosage form is expensive, resulting in inconsistent pharmacological effects and pharmacokinetic profiles. Hence, prodrugs of THC are synthesized for the delivery by transbuccal route. The objective is to enhance the thermal stability and permeation properties of the hemisuccinate ester prodrug of Δ^9 -tetrahydrocannabinol (THC-HS) by complexation with random methylated beta cyclodextrin (RAMEB). An inclusion complex of THC-HS/RAMEB was prepared by freeze-drying THC-HS and cyclodextrin (1:2 and 1:10 ratios). Stability was evaluated at 4 °C, 25 °C and 40 °C in open and closed vials over a period of 1 month. Diffusion of THC-HS from THC-HS/RAMEB com-

plex, across porcine buccal mucosa, was studied at 37°C, using side-by-side diffusion cells. The degradation rate was higher in open vials as compared to closed vials. The permeability of THC-HS/RAMEB (1:2) freeze-dried complex was increased four-fold and that of the 1:10 complex increased two-fold compared to the permeability of the THC-HS alone. The inclusion complex of THC-HS/RAMEB significantly enhances the thermal stability and permeation properties of THC-HS.

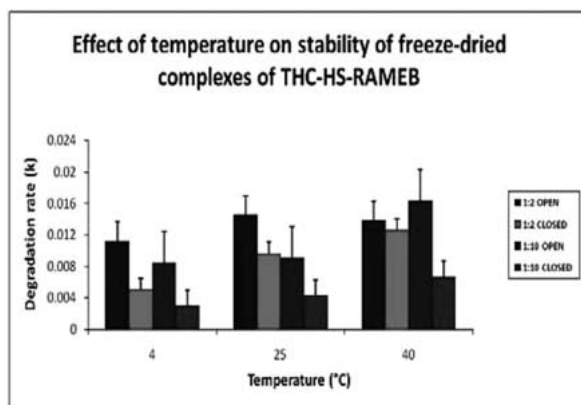

Fig. 1 Effect of temperature on stability of THC-HS: RAMEB complex.

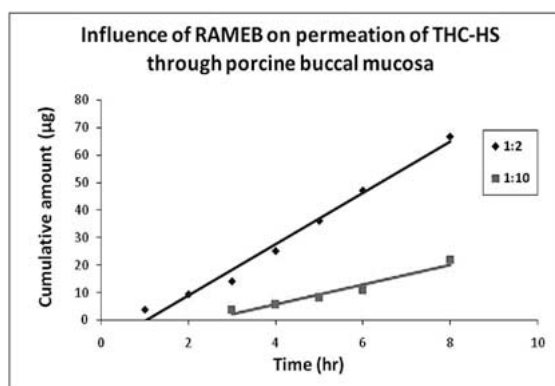

Fig. 2 Effect of RAMEB on permeability of THC-HS.

Acknowledgements: Grant Number P20RR021929 – National Center For Research Resources (NIH/NCRR). **References:** [1] Munjal M, et al. (2006), AAPS Pharm SciTech, 7(3): E1–E12

P-92

Variability of In Vitro Macrophage Activation by Commercially Diverse Bulk Echinacea Plant Material is Due Predominantly to Bacterial Lipoproteins and Lipopolysaccharides

Tamta H¹, Pugh ND¹, Balachandran P¹, Moraes RM¹, Sumiyanto J¹, Pasco DS^{1,2}

¹ National Center for Natural Products Research,

² Department of Pharmacognosy, Research Institute of Pharmaceutical Sciences, School of Pharmacy, The University of Mississippi, University, MS 38677-1848, USA

We previously reported that the majority of *in vitro* monocyte/macrophage activation exhibited by extracts of *Echinacea* and other botanicals depends on bacterial lipopolysaccharides and Braun type bacterial lipoproteins [1]. We determined the contribution made by these bacterial components to the overall immune enhancing activity detected in *E. purpurea* and *E. angustifolia* from bulk root and aerial material obtained from six major growers/suppliers in North America. Substantial variation in activity (up to 200-fold) was observed in extracts of these materials when tested in two monocyte/macrophage cell lines. The majority of activity was negated by treatment with agents that target bacterial lipoproteins

(lipoprotein lipase) and lipopolysaccharides (polymyxin B). Experiments comparing the activity of freeze dried, freshly harvested *Echinacea* plants with those harvested and dried using various commercially relevant conditions, suggest that post-harvesting procedures do not substantially contribute to the variation observed in the commercial material. **Acknowledgements:** This research was partially funded by grants from the National Institutes of Health RO1 AT002360 (NCAAM) to DSP and the USDA, Agricultural Research Service Specific Cooperative Agreement No. 58-6408-7-012. **References:** [1] Pugh ND, et al. (2008), Int Immunopharmacology, 8: 1023–1032.

P-93

Enhancement of Natural Killer Cell Activity and Phagocytosis in Healthy Subjects by Immulina, a *Spirulina* Extract Enriched for Braun Type Lipoproteins

Balachandran P^{1,3}, Pugh ND^{1,3}, Tamta H^{1,3}, Sufka KJ^{3,4,5}, Wu XM^{1,3}, Pasco DS^{1,2,3}

¹ National Center for Natural Products Research,

² Department of Pharmacognosy,

³ Research Institute of Pharmaceutical Sciences, School of Pharmacy,

⁴ Department of Psychology, ⁵Department of Physiology, The University of Mississippi, University, MS 38677-1848, USA

Immulina is a commercial extract of *Spirulina* (*Arthrospira*) *platensis* that is standardized by biological activity. We previously reported that this extract is a potent activator of THP-1 monocytes *in vitro* and that oral consumption enhanced several immunological functions in mice [1]. In this study we further characterized Immulina by determining that Braun type lipoproteins are responsible for a major portion of the *in vitro* monocyte activation exhibited by this material. In order to understand the effect of Immulina on the human immune system, a pilot study was conducted on ten healthy individuals who supplemented their diet with Immulina (400 mg/day) for seven days. Blood was drawn from the participating individuals at two time points: before and after seven days of Immulina supplementation. Changes in mononuclear and polymorphonuclear phagocytosis were determined in heparinized whole blood as well as the cytotoxicity exhibited by natural killer (NK) and lymphokine activated killer cells. We observed statistically significant increases both in tumor cell killing by NK cells ($p=0.0019$) and in phagocytosis by blood mononuclear cells ($p=0.0124$) after Immulina supplementation. **Acknowledgements:** This research was partly funded by a USDA, Agricultural Research Service Specific Cooperative Agreement No. 58-6408-012. Immulina capsules were supplied by Scandinavian Clinical Nutrition Denmark A/S, Greve, Denmark. **References:** [1] Balachandran P, et al. (2006), International Immunopharmacology, 6: 1808–1814.

P-94

Can Green Tea Extract Become a Cause of Acute Pancreatitis?

Hammad M¹, Haron M¹, Madgula L¹, Ashfaq MK¹, Walker LA¹

¹ National Center for Natural Product Research, School of Pharmacy, University of Mississippi, University, MS 38677

Acute pancreatitis is a local inflammatory process that could occur due to multiple causes. This condition is diagnosed by elevated plasma amylase. In mice there is only one predominant model of acute pancreatitis, in which hyper-stimulatory doses of cholecystokinin or its analog caerulein are administered [1]. Nothing is known about herbs and botanicals for their potential to cause acute pancreatitis. We report a suspected potential of green tea extract to cause acute pancreatitis in mice. Balb/C mice 20–25 g was administered by oral gavage 200 uL of commercially available green tea extract. After 18 hours blood samples were taken and were analyzed for plasma chemistry profile and complete blood picture. Mice that were given green tea extract showed elevated plasma amylase (mean = 1428 ± 546.27 U/L) whereas in the normal mice the mean was 58.0 ± 0.4 U/L. In addition, slight elevation of plasma Alanine Aminotransferase (ALT) was observed (mean 127 ± 79.45 U/L) com-

pared to normal controls (30 U/L). The Blood Urea Nitrogen (BUN) values were also raised (81 ± 51.0 mg/dl) compared to normal control (21 U/L). Green tea administered mice showed hyperactivity or restlessness compared to normal controls. The blood picture showed slight elevation of granulocytes (ranging from 26.8 to 83.2% Mean 54%) as compared to normal that range between 8 to 48%. Plasma amylase elevation is a good indicator of acute pancreatitis. An increase in BUN and BUN: Creatinine (CRE) ratio is one of the manifestations of dehydration. In our study, plasma amylase was remarkably increased in mice administered green tea. The caffeine in the green tea extract may have caused dehydration due to increased urination hence increasing BUN and BUN: CRE ratio. We conclude that green tea extract in the doses administered in this study could lead to acute pancreatitis. Further studies are needed to confirm these results along with histopathology of treated pancreas. **References:** [1] Lampel M, Kern HF, (1977), *Virchows Arch A Pathol Anat Histol*, 373(2): 97–117.

P-95

Allicin Bioavailability from Alliinase-Inhibited Garlic Lawson LD¹

¹ Silliker, Inc., Utah Laboratory, 95 S. Mountain Way Drive, Orem, Utah 84058, USA

Allyl thiosulfates (75% allicin) are responsible for most of the known health benefits of crushed raw garlic. Absent in garlic cloves, they are rapidly produced from alliin when endogenous alliinase is activated by crushing the cloves. The alliinase-dependent production of allyl thiosulfates (hereafter called allicin) is known to be completely inhibited by heat and acid ($\text{pH} \leq 3.5$) in vitro, bringing into question any allicin-related health benefits of cooked garlic or garlic powder supplements not protected from gastric acid. Indeed, most supplement brands have been shown to produce little allicin under USP/NF-defined simulated gastrointestinal conditions. To determine if allicin production in the human body might be different from in vitro predictions, a method for measuring allicin bioavailability was developed (breath AUC of its main metabolite, allyl methyl sulfide) and applied to heat-inactivated and acid-inactivated garlic. Allicin bioavailability from the alliin of boiled garlic was found to be 18% (14–25%), much higher than expected, with a similar result for garlic powder suspended in 1 N HCl ($\text{pH} 0.6$). When garlic powder was consumed in capsules with a low protein meal (expected gastric $\text{pH} < 3$), 34% of the alliin was converted to allicin, indicating that the local pH is increased by the dissolving capsule. When pure alliin was consumed, only 4% of it was converted to allicin, probably by intestinal bacteria. The substantial difference in allicin bioavailability between heat- or acid-inactivated garlic (18%) and pure alliin (4%) indicates that the body has the ability to partially reactivate inactive alliinase. This work has important implications: (1) the health benefits of raw garlic can be obtained with cooked garlic, if consumed in larger amounts, as is often the case, and (2) allicin bioavailability from garlic powder supplements may be considerably higher than predicted in vitro, depending on how they are made and consumed.

P-96

Anti-Biofilm Activity of *Marrubium vulgare* L. (Lamiaceae) Extract on MRSA

Quave CL¹, Smeltzer M¹

¹ University of Arkansas for Medical Sciences, Department of Microbiology and Immunology, 4301 W Markham St., Mail Slot 511, Little Rock, AR 72205-7199, USA

Many plants possess potent antimicrobial agents and provide effective remedies for skin conditions. Infusions of the aerial parts of *Marrubium vulgare* (white horehound) are used in the south Italian pharmacopoeia as a rinse for skin rashes and wounds [1]. *Staphylococcus aureus*, a common cause of skin infections, has generated increasing concern among health care professionals due to the prevalence of drug resistant strains. Identification of novel antibiotics and anti-biofilm agents for methicillin-resistant *S. aureus* (MRSA) is important to healthcare on a global scale. The aim of this study was to evaluate extracts from *Marrubium vulgare* for *in vitro* inhi-

bitation of planktonic growth, biofilm formation and adherence in MRSA. A broth microtiter dilution method was employed to determine the MIC after 18 hours growth using an optical density ($\text{OD}_{600\text{nm}}$) reading using a MRSA isolate (ATCC 33593). The impact of extracts on biofilm formation and adherence was tested by growing biofilms for 40 hours, then fixing and staining with crystal violet. After washing, 10% Tween 80 was added and $\text{OD}_{570\text{nm}}$ readings were taken. A crude ethanolic extract of the roots was the most effective at inhibiting both biofilm formation ($\text{IC}_{50} = 32 \mu\text{g/ml}$) and adherence ($\text{IC}_{50} = 8 \mu\text{g/ml}$). A significant dose-dependent response for the inhibition of both biofilm formation and adherence was evident. **Acknowledgements:** This work was funded by NIH/NCCAM F32AT005040 (PI: C.L. Quave). **References:** [1] Quave, C.L. et al. (2008) *J. Ethnobiol. Ethnomed.* Vol. 4: 5.

P-97

Antitumor Activity of *Aralia racemosa*

Clement JA¹, Willis TJ¹, Kelly RM², McCoy JA², Schmitt JD²

¹ Department of Chemistry and Physics, Western Carolina University, Cullowhee, NC, USA

² Bent Creek Institute, Asheville, NC, USA

The southern Appalachians are home to an extraordinary variety of plant species, many of which have been used medicinally by local populations. The vast majority of these species have not been studied for their antitumor activity, constituting a significant bioexploration opportunity. We have recently begun a targeted screening program for identifying plants indigenous to Western North Carolina with potential antitumor activity. Initial screening against the MCF-7 breast tumor cell line identified an extract of *Aralia racemosa* (aerial parts) as having cytotoxic activity. Combined CH_2Cl_2 extractions of the acidified crude organic extract showed dose-dependent toxicity towards MCF-7 cells, with IC_{50} around 100 $\mu\text{g/ml}$. Bioassay-guided fractionation by reverse phase C_{18} open column chromatography, followed by reverse phase C_{18} HPLC, afforded the major cytotoxic component, a twenty-carbon terpenoid, along with an inactive twenty-carbon compound. The major cytotoxic compound gives 73% inhibition growth of MCF-7 cells at 100 $\mu\text{g/ml}$. The structure has been characterized by NMR spectroscopy and ESI-MS, and these results will be presented. **Acknowledgements:** We thank the Western Carolina University SURF Program for summer support for T.J.W. We thank Wake Forest University Health Sciences Virus and Vector Core Laboratory for assay work.

P-98

Antitumor Activity of *Arnoglossum atriplicifolium*

Kelly RM¹, Clement JA², Garrett SE², Kridell S³, Schmitt JD¹

¹ Bent Creek Institute, Asheville, NC, USA

² Department of Chemistry and Physics, Western Carolina University, Cullowhee, NC, USA

³ Wake Forest University Health Sciences, Winston-Salem, NC, USA

Western North Carolina is home to one of the most diverse collections of botanical species in the temperate world. The region is also an extensive repository of herbal natural healing knowledge, developed through the centuries by Native American and European settler practitioners, regional plant species with documented medicinal properties number in the hundreds. These factors combine to present urgent need for Western North Carolina to use cutting edge technology to identify, validate, protect, and use its matchless natural resources in innovative, sustainable, and productive ways including careful bioexploration. We have recently launched a targeted screening program for identifying plants indigenous to Western North Carolina with potential antitumor activity. Initial screening against the MCF-7 breast tumor cell line identified an extract of *Arnoglossum atriplicifolium* (whole plant) as having cytotoxic activity. Numerous lipophilic fractions exhibit dose-dependent toxicity towards MCF-7 and PC-3 cells, with IC_{50} values as low as 20 $\mu\text{g/ml}$. The results of bioassay-guided fractionation by reverse phase C_{18} open column chromatography followed by reverse phase C_{18} HPLC will be presented as will data demonstrating that many of the frac-

tions show low to moderate cytotoxicity against fibroblasts in cell culture. **Acknowledgements:** This work was supported, in part, by the NC Biotechnology Center's Biotechnology Research Program grant. We thank the Western Carolina University Quality Enhancement Program for summer support for T.J.W. We thank Wake Forest University Health Sciences Virus and Vector Core Laboratory for assay work.

P-99

Biomarker Compounds in Muscadine and their Effects on Colon Cancer Cells

Ranwala D¹, Lane H², Wargovich M², Gangemi J¹

¹ Clemson University Institute for Nutraceutical Research, Coastal Research & Education center, Charleston, SC 29414, USA

² Department of Cell and Molecular Pharmacology, Medical University of South Carolina, Charleston, SC 29425, USA

Muscadine (*Vitis rotundifolia*) is a native and valuable fruit crop in Southeastern US. Today muscadine products are commercially available as nutraceuticals. Major concerns in nutraceuticals are product quality and their effects on human health. This study was conducted to evaluate muscadine nutraceutical powder derived from pomace (cv. Noble) for biomarker compounds and their effects on colon cancer cell lines. The powder was extracted after acid hydrolysis. The extract (CE) was further fractionated to obtain flavonoid and anthocyanin fractions (FAF). Total phenolic (TP) and flavonoid (TF) contents, and individual biomarker compounds in each fraction were analyzed using colorimetric assays and HPLC-PDA, respectively. The TP and TF contents in the fractions were higher compared to those of CE. The main polyphenol present in CE was ellagic acid, not resveratrol as in table grapes. The major anthocyanins present were 3,5-diglucosidic anthocyanins in contrast to monoglucosidic anthocyanins present in table grapes. The effects of CE and FAF were tested in two colon cancer cell lines, HT-29 and HCT-15, for cytotoxicity and cell cycle arrest. Cell proliferation assays and flow cytometry data showed that FAF decreased viable cell proliferation in both cell lines, and evidence of G1 arrest as compared to CE. These results indicate the bioactivity of fractions rich in flavonoids and anthocyanins may be higher than that of CE in inhibiting colon cancer cell growth.

P-100

Anti-inflammatory, Analgesic and Antioxidant Activities of *Ipomoea hederaceae* Linn.

Kumar S¹, Kumar D¹, Singh J¹, Narender R¹, Kaushik D¹

¹ Institute of Pharmaceutical Sciences, Kurukshetra University, Kurukshetra-136119, Haryana, India

Ipomoea hederaceae Linn. [Family: Convolvulaceae] is commonly known as Pharbitis Seeds (English) and Kala-Dana in local language. It is found wild and cultivated throughout India. Traditionally, the seeds of this plant are used in severe headache, fever, inflammation, and as a blood purifier [1,2]. Considering the traditional uses of this drug, preliminary phytochemical studies and presence of polyphenolic contents, this study was conducted to evaluate antioxidant, anti-inflammatory and analgesic activities of *I. hederaceae*. Methanolic seed extract was screened to evaluate its free-radical scavenging effect at different concentration (100–500 µg/ml) by using various in vitro methods [3]. The extract exhibited significant reducing power and free scavenging effect on the DPPH, superoxide anion and nitric oxide production as 88.28 ± 0.7, 21.78 ± 3.5 and 55.91 ± 2.5%, respectively at a concentration of 500 µg/ml. Subsequent quantification showed the presence of 0.82% w/w phenolics (calculated as garlic acid) per 100 g of dry mass of *I. hederaceae*. The methanolic seed extract was also screened for analgesic effect by hot plate, tail immersion, tail flick and writhing syndrome at various doses (100, 200 and 500 mg/kg). The results were also compared with standard drug diclofenac sodium. The extract showed significant activity (p < 0.001) at 500 mg/kg [4,5]. The extract at various doses (100, 200 and 500 mg/kg) was also screened for anti-inflammatory activity by carrageenan induced rat hind paw oedema method. Oedema was

induced by injecting 0.1 ml carrageenan suspension (1%) subcutaneously into the sub-plantar side of hind paw [6]. Paw volume was measured by displacement of the water column in a plethysmometer. Methanolic seed extract showed significant (p < 0.01) anti-inflammatory activity at 500 mg/kg dose. **References:** [1] Joshi SG, (2003), Medicinal Plants, Oxford & IBH Publishing Co. Pvt. Ltd. New Delhi, p. 150. [2] Nadkarni KM, (2005), Indian Materia Medica, 3rd edition, Vol. 1, Popular Parkashan, Mumbai, India, p. 688. [3] Kumar S, et al. (2008), Acta Pharm 58: 215–220. [4] Collier HDJ, et al. (1968), Pharmacol Chemother, 32: 295–310. [5] Eddy NB, Leimbach DJ, (1953), Pharmacol Exp Ther 107: 385–393. [6] Winter CA, Porter CC, (1957), J Am Pharm Assoc 46: 515–519.

P-101

Purification, Characterization and In vitro Cytotoxicity of L-asparaginase from *Withania somnifera* L. Against Acute Lymphoblastic Leukemia

Oza VP¹, Parmar PP¹, Subramanian RB¹

¹ Department of Plant Biotechnology, B R D School of Biosciences, Sardar Patel University, P. O Box No. 39, Vallabh Vidyanagar 388 120 (Gujarat) India, Email: subramanianrb@gmail.com, Tel: +91-2692-234402, Fax: +91-2692-236475

Withania somnifera L. has been traditionally used as a sedative and hypnotic. *Withania somnifera* L. is reported to have anti-carcinogenic effects in animal and cell cultures by decreasing the expression of nuclear factor-kappaB, suppressing intercellular tumor necrosis factor, and potentiating apoptotic signalling in cancerous cell lines [1]. The present study was carried out on the purification, characterization and in vitro cytotoxicity of L-asparaginase from *Withania somnifera* L., a popular medicinal plant. L-asparaginase was purified from the crude extract of the fruits of *Withania somnifera* L. up to 95% through column chromatography. The purified L-asparaginase was characterized by size exclusion chromatography, PAGE and 2-D PAGE. The antitumor and growth inhibition effect of the L-asparaginase was assessed using MTT colorimetric dye reduction method. The purified enzyme is a homodimer, with a molecular mass of 72 ± 0.5 kDa, and pI value of the enzyme was around 5.1. It is the first report for plant L-asparaginase with antitumor activity. Data obtained from the MTT assay indicated that L-asparaginase significantly (P < 0.05) reduced the viability of lymphocyte cells in a dose-dependent manner, showing a LD50 value of 1.45 ± 0.05 IU/ml. *Withania somnifera* L. proved to be an effective and a novel source of L-asparaginase, furthermore it shows lot of similarity with bacterial L-asparaginases which have already been commercialized for the treatment of acute lymphoblastic leukemia. **References:** [1] Ichikawa H, et al. (2006), Molecular Cancer Therapeutics, 5(6): 1434–1445.

P-102

Antioxidant, Analgesic and Anti-inflammatory Activities of *Santalum album* Linn.

Saneja A¹, Kaushik P¹, Kaushik D¹, Kumar S¹, Kumar D¹

¹ Institute of Pharmaceutical Sciences, Kurukshetra University, Kurukshetra-136119, Haryana, India, Email: saneja234@gmail.com

Santalum album Linn. [Family: Santalaceae] is commonly known as White sandalwood (English), Safed Chandan (Hindi) and Srigandha (Sanskrit). It is found wild and cultivated in southern states of India. Traditionally, this plant is used in headache, fever and inflammation. The wood oil is used as diuretic, stimulant and disinfective. Sandalwood contains a volatile oil 2.5–6%. The main constituents of volatile oil are santalol, isovaleric aldehyde, santanone, santalone and tannic acid. Based upon its traditional use and chemical constituents, the wood of the plant was selected and evaluated for antioxidant, analgesic and anti-inflammatory activities. The methanolic wood extract was screened for antioxidant and free radical scavenging effects at various doses (100–500 µg/ml) by different specific in vitro methods and compared with L-Ascorbic acid and BHA. It was found that extract showed maximum antioxidant effect at 500 µg/ml. The methanolic extract of wood was also screened for

analgesic and anti-inflammatory activities at various doses (100, 250 & 500 mg/kg) and compared with Diclofenac sodium (7 mg/kg) taken as standard. The extract showed maximum effect at 500 mg/kg. The statistical analysis of all the results was carried out using one-way ANOVA followed by Dunnet's *t*-test and all the results obtained in the study were compared with the vehicle control group. *P* values < 0.001 were considered statistically significant. **Acknowledgement:** The authors are highly thankful to Director, I.P.S., Kurukshetra University, Kurukshetra for carrying out research activities. **References:** [1] Joshi SG. Medicinal Plants, Oxford & IBH Publishing Co. Pvt. Ltd., New Delhi, 2003, 157–158. [2] Nadkarni AK, Nadkarni KM, Indian Materia Medica, Vol. I, Popular Prakashan, Bombay, 2005, 403–404. [3] The Wealth of India: A dictionary of raw materials & Industrial products, 1st supplement series (Raw Materials), Vol. 2: Cl-Cy, NISCAIR, CSIR, New Delhi, 2004 255.

P-103

Evaluation of Ethanolic Extract of *Withania somnifera* on Haloperidol Induced Iron Deficiency Anemia in Albino Rats

Pawar RS², Yadav SK², Singhai AK¹

¹ Division of Pharmacognosy and Phytochemistry, Department of Pharmaceutical Sciences,

Dr. H.S. Gour University, Sagar, (M.P.) 470003, India

² VNS Institute of Pharmacy, Neelbad, Bhopal 462044 (M.P.), India

Medicinal plants are believed to be useful in strengthening the haematopoietic and immune system. Our objective was to investigate ethanolic extract of the root part of *Withania somnifera* (WS) on hematological parameters as well as serum iron and serum protein in iron deficiency anaemia induced using haloperidol and observe the morphological changes in red blood cells. The animals were divided into five groups. Group I acted as control, group II was haloperidol control (0.2 mg/kg body weight i.p.), group III was treated with ethanolic extract alone (200 mg/kg body weight i.p.), group IV and V were given HP and ethanolic extract at the doses of 100 and 200 mg/kg body weight i.p., respectively [1]. Effect of haloperidol on group II showed significant (*P* < 0.05) decrease in blood parameters, serum iron and serum protein, as compared to control animals group I. Comparison of group II with group III, IV and V exhibited significant (*P* < 0.05) increase in hematological parameters, serum iron and serum protein after four days and after recovery period study (on 19th day). This effect may be due to presence of iron in extract (947 µg in 50 ml.) estimated quantitatively by spectrophotometric method. Effect of ethanolic extract of *Withania somnifera* on morphology of blood cells was observed. It accelerated the oxygen carrying capacity of red blood cells and showed increased number of RBCs with normal counts and normocytic shape. We conclude that WS exhibited potent haematopoietic activity against haloperidol induced iron deficiency anaemia [2]. **Acknowledgements:** Thanks go to the University Grant Commission, (UGC-SRF Fellowships) New Delhi for financial support. **References:** [1] Ziauddin, M. et al (1996) *J. of Ethnopharm.* p.50: 69–76. [2] Wasti, A., Ghani, R., Manji, M.A. and Siddiqui, N.A., (2004) *Pak. J. Med. Sci.*, Vol. 20 (3), p. 197–200.

P-104

Anti-carcinoma Activity of Polyphenolic Extract of *Ichnocarpus frutescens*

Kumarappan CT^{1,2}, Senthil S¹, Thiagarajan M¹, Balamurugan M¹, Radhakrishnan M¹, Mandal SC²

¹ Department of Pharmacology, The Erode College of Pharmacy, Erode, India 638112

² Department of Pharmaceutical Technology, Jadavpur University, Kolkata, India 700032

Dietary polyphenol antioxidants are known to decrease the risk of many diseases such as cancer and cardiovascular diseases [1]. In this study polyphenolic extract (PPE) of leaves of *Ichnocarpus frutescens* was evaluated for antitumor activity in vivo. Murine Ehrlich ascites carcinoma (EAC) model was used to assess PPE antitumor activity in vivo [2]. PPE cytotoxicity was determined in vitro in U-

937 monocytoid leukemia and K-562 erythroleukemia cell lines. The total phenolics content was quantified by the Folin-Ciocalteu method [3]. Results of in vivo study showed a significant decrease in tumor volume, viable tumor cell count and a significant increase of life span in the PPE treated group compared to untreated one: the life span of PPE treated animals increased by 53.41% (50 mg PPE/kg) and 73.95% (100 mg PPE/kg). PPE (5, 10 and 20 µg/mL) effectively inhibits in vitro proliferation of U-937 and K-562 cell lines. The in vitro and in vivo anti-tumor activity of PPE from *Ichnocarpus frutescens* could be due to rich polyphenols and flavonoids [4]. **Acknowledgements:** All India Council of Technical Education (AICTE), Government of India, New Delhi, India is greatly acknowledged. **References:** [1] Kuroda Y, Hara Y, (1999), *Mutation Research*, 436: 69–97. [2] Clarkson BD, Burchenal JH, (1965), *Progress in Clinical Cancer*, 1: 625–629. [3] Chang CC, et al. (2002), *Journal of Food Drug Analysis*. 10: 178–182. [4] Singh RP, Singh RP, (1987), *Journal of Indian Chemical Society*, 715–756.

P-105

Obesity Associated Dementia Among Elderly – Role of a Plant Based Formulation

Agrawal A¹, Rastogi M², Ojha RP², Rajamanickam GV⁴, Dubey GP⁵

¹ Institute of Medical Sciences, Banaras Hindu University, Varanasi

² Centre for Advanced Research in Indian System of Medicine, (CARISM) SASTRA University, Thanjavur

³ CARISM, SASTRA University, Thanjavur

⁴ CARISM, SASTRA University, Thanjavur

⁵ CARISM, SASTRA University, Thanjavur

The main object of the present study was to evaluate association between obesity and dementia in elderly people and its prevention and management by a herbal formulation. Under this clinical trial 80 men and women (aged 61 to 79 years,) underwent a detailed health evaluation, showing a high BMI with a major complaint of loss of memory and deterioration of other cognitive functions were treated with a novel herbal formulation containing hydro-alcoholic extract of *Dioscorea bulbifera*, *Salacia oblonga* and *Hippophae rhamnoides* in effective doses. Normal 58 aged (31 male and 27 female, BMI 18–25) with normal cognitive functions, and 57 (33 male and 24 female) underweight aged (BMI < 18 with poor mental abilities) were also treated with test formulation. The test drug exerted beneficial effects on BMI, mental functions particularly on memory and attention span, inflammatory marker CRP including Homocysteine, plasma leptin and adiponectin levels during six months of study period. It is concluded that test formulation enhanced the satiety, decreased appetite and fat absorption through regulation of 5-HT, leptin and adiponectin receptors involved in the onset of obesity. Thus, by regulating adipokines, memory, attention span and other cognitive impairments significantly improved among obese elderly demented subjects. Improvement in mental performance was also noticed in normal as well as under weight aged also following test formulation treatment. Pre-clinical toxicity studies revealed that drug is safe and can be given for longer time.

P-106

Neuropsychological Risks Associated with Menopausal Women – Benefits of a Plant Based Formulation

Dubey GP¹, Rajamanickam GV², Aruna Agrawal A³

¹ Institute of Medical Sciences, Banaras Hindu University

² CARISM, SASTRA, Thanjavur

³ Institute of Medical Sciences, Banaras Hindu University

The anatomic, physiologic alterations in the ovary that eventually result in diminished estrogen production begin several years before permanent cessation of menstruation among the women. The relationship between menopause and cardiovascular risk is established and it is well documented that estrogen depletion is responsible for cardiovascular risk. A double blind placebo controlled study was carried out with the object to minimize the neuro-psychological risks associated with menopausal women by a

plant based formulation containing the organic extract of *Dioscorea bulbifera* and *Hippophae rhamnoides* in effective doses. After determination of safety and efficacy profile in various animal studies, the drug was slated for human trials. The beneficial role of the test drug was validated on coronary heart disease (CHD) risk biomarkers particularly lipid profile, homocysteine, C-reactive Protein, Interleukin-6, along with anxiety and depression among 65 menopausal women. A group of 38 menopausal women were kept on placebo therapy to compare results. It is observed that the novel test formulation has potential effect in reducing the elevated plasma homocysteine, C-reactive protein and Interleukin-levels. It also regulated the abnormal lipid levels, and thus, the future incidence of atherosclerotic vascular disease can be prevented among menopausal women without any adverse effect.

P-107

Pharmacokinetic Interaction of Ginkgo Biloba with Carbamazepine

Harish Chandra R¹, Rajkumar M¹, Veeresham C¹

¹ Department of Pharmacognosy, University College of Pharmaceutical Sciences, Kakatiya University, Warangal-506009, Andhra Pradesh, India

Ginkgo biloba L. (Ginkgoaceae) usage has recently gained interest among herbalists and modern medical practitioners because of its unique pharmacological actions that are attributed to active substances such as flavonoids and terpenoids [1]. It is commonly prescribed for improvement of cerebral circulation, memory improvement and antioxidant activity. Epileptics have a greater chance of oxidative stress and memory impairment. *G. biloba* can be used as an alternative remedy in specific conditions such as oxidative stress and memory impairment [2]. This study aims to evaluate the pharmacokinetic interaction between the aqueous extract of *Ginkgo biloba* and carbamazepine. Two groups of animals, each containing 6 animals were used. The Group 1 and Group 2 received pretreatment with two different doses of extract for 7 days and on day 8 the extract was co-administered with carbamazepine. The Group 3 (control) received carbamazepine alone on day 8. The blood samples were collected for 24 hours. Samples were analyzed by HPLC [3] and pharmacokinetic parameters were calculated. Analysis of the data reveals that there was very significant decrease ($p < 0.05$) in the C_{max} ($4.32 \pm 0.24 \mu\text{g/ml}$), AUC_{total} ($20.31 \pm 1.41 \mu\text{g/ml h}$) and $AUC_{0 \text{ to } n}$ ($18.31 \pm 1.06 \mu\text{g/ml h}$) of Group 1 when compared to C_{max} ($6.76 \pm 0.40 \mu\text{g/ml}$), AUC_{total} ($36.79 \pm 1.57 \mu\text{g/ml h}$) and $AUC_{0 \text{ to } n}$ ($34.81 \pm 1.23 \mu\text{g/ml h}$) of control. There was also a significant decrease in the C_{max} ($3.51 \pm 0.28 \mu\text{g/ml}$), AUC_{total} ($11.60 \pm 0.93 \mu\text{g/ml h}$), $AUC_{0 \text{ to } n}$ ($10.33 \pm 0.82 \mu\text{g/ml h}$), and MRT ($3.53 \pm 0.24 \text{ h}$) of Group 2 when compared to C_{max} ($6.76 \pm 0.40 \mu\text{g/ml}$), AUC_{total} ($36.79 \pm 1.57 \mu\text{g/}$

ml h), $AUC_{0 \text{ to } n}$ ($34.81 \pm 1.23 \mu\text{g/ml h}$) and MRT ($5.59 \pm 0.24 \text{ h}$) of control. There was no significant difference in the $t_{1/2}$ of the drug in both study groups when compared with control. This data suggest that *Ginkgo biloba* reduced the bioavailability and increased the rate of elimination of carbamazepine which confirms that there is significant herb-drug interaction between the two. **References:** [1] Kleijnen J, Knipschild P, (1992), Lancet, 340: 1136–1139. [2] Christen Y, (2004), Frontiers in Bioscience, 9: 3091–3104. [3] Kishore P, Krishna DR, (2003), Drug Research, 53: 763–768.

P-108

Antileishmanial Activity, Pharmacokinetics and Tissue Distribution Studies of Mannose Grafted Piperine Lipid Nanospheres

Veerareddy PR¹, Vobalaboina V¹, Ali N²

¹ University College of Pharmaceutical Sciences, Warangal, Andhra Pradesh, India-5006 009

² Indian Institute of Chemical Biology, Jadavpur, Kolkata 700032, West Bengal, India

Leishmaniasis is a complex of disease syndromes, caused by protozoan parasites of the genus *Leishmania* [1]. The aim of this study was to evaluate antileishmanial activity, pharmacokinetics and tissue distribution studies of mannose grafted piperine lipid nanospheres (LN-P-MAN) in BALB/c mice. Lipid nanospheres of piperine (LN-P) and LN-P-MAN were prepared by homogenization followed by ultrasonication. Particle size and Zeta potential were determined using Malvern Zeta Sizer. Antileishmanial activity of piperine, LN-P and LN-P-MAN was assessed in BALB/c mice infected with *Leishmania donovani* AG83 for 60 days. A single dose (5 mg/kg) of piperine, LN-P and LN-P-MAN was injected intravenously. Mice were sacrificed after 15 days of treatment with piperine, LN-P, LN-P-MAN and Leishman Donovan Unit (LDU) is counted (2). The size and Zeta potential were $196.0 \pm 1.7 \text{ nm}$ to $365 \pm 4.7 \text{ nm}$ and $-35.6 \pm 0.2 \text{ mV}$ to $-44.3 \pm 0.8 \text{ mV}$, respectively. The entrapment efficiency and drug content were 99.36 ± 0.05 to $99.92 \pm 0.04\%$ and 0.98 ± 0.01 to $0.91 \pm 0.04 \text{ mg/ml}$, respectively. The peak plasma concentrations of LN-P and LN-P-MAN were approximately 3 to 3.5 folds higher than piperine. Piperine reduced 36% and 35%, LN-P reduced 63% and 52%, while LN-P-MAN reduced 94% and 89% of parasite burden in liver and spleen after 15 days of postinfection, respectively. Pharmacokinetics of piperine in lipid nanospheres showed a biexponential decline with significantly high AUC, lower rate of clearance and smaller volume of distribution in comparison with piperine. LN-P-MAN showed highly reduced parasite burden than piperine. **References:** [1] Boelaert M, et al. (2000), Trans R Soc Trop Med Hyg, 94: 465–471. [2] Stauber LA, et al. (1958), J Protozoal, 5: 269–273.

Erratum

7th Annual Oxford International Conference on the Science of Botanicals & American Society of Pharmacognosy, 4th Interim Meeting, April 12–16, 2008, University of Mississippi, Oxford, MS, USA

P-21

Anticancer and Antimalarial Dihydroartemisinin Dimer Oximes

Gul W^{1,2}, Galal A², Slade D², Khan S², ElSohly MA^{1,2,3}

¹ ElSohly Laboratories, Inc., 5 Industrial Park Drive, Oxford, MS 38655, USA

² National Center for Natural Products Research,

³ Department of Pharmaceutics, School of Pharmacy, The University of Mississippi, University, MS 38677, USA

The natural product artemisinin (1), a sesquiterpene endoperoxide first isolated in 1971 from the Chinese plant *Artemisia annua* [1], has cytotoxic effects against EN-2 tumor cells [2], P-388, A549, HT-29, MCF-7 and KB-tumor cells [3]. In an attempt to develop new chemotherapeutic agents, dihydroartemisinin (DHA) dimer oximes were prepared by condensation of DHA (2) with dihydroxy-acetone to afford 3, followed by conversion into the dimer oximes (4–7). These oximes showed anticancer [4], and anti-malarial activity. Synthesis, spectroscopic data and *in vitro* biological activity of these compounds are presented. **References:** [1] Coordinating Group for Research on the Structure of Qing Hau Sau: A new type of sesquiterpene lactone (1977) *Kexue Tongbao*, 22: 142. *Chemical Abstracts* (1977) 87: 98788 g. [2] Beekman AC, et al. (1997) *Journal of Natural Products* 60: 325–330. [3] Zheng GQ (1994) *Planta Medica*, 60: 54–57. [4] ElSohly MA, Gul W, International Publication # WO 2006002105 A1.

P-113

Pregnane Derivatives from *Hoodia gordonii*

Shukla YJ¹, Pawar RS², Khan IA¹

¹ Department of Pharmacognosy, University of Mississippi, University, MS, 38677

² National Center for Natural Products Research (NCNPR), University of Mississippi, University, MS, 38677

Hoodia gordonii (Fam. Asclepiadaceae) is a succulent plant indigenous to South Africa, Botswana and Namibia. *Hoodia* has gained

wide popularity as one of the most sought after dietary supplements for its appetite suppressant activity. P57AS3, the reported active constituent from *H. gordonii*, is claimed to induce increased ATP synthesis in the hypothalamic neurons, thereby reducing appetite by giving out false satiety signals to the appetite center. In our previous phytochemical studies, we had reported isolation of several oxypregnane glycosides and calogenin bisdesmosides, including P57AS3. Here, we report isolation and characterization of nine pregnane glycosides, including two novel *abeo*-sterol aldehyde glycosides, (1), and, (2). This is a first report of *abeo*-sterols from *Hoodia spp.* The chemical structures of the glycosides were established by chemical degradation studies and extensive spectroscopic techniques that included one-dimensional and two-dimensional NMR.

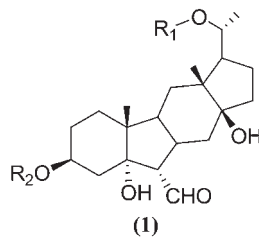

R₁: β -D-glucopyranose

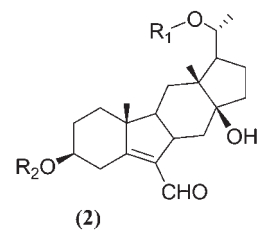

R₂: β -(4-O-tigloyl)-D-thevetopyranosyl-(1→4)- β -D-oleandropyranoside

Acknowledgements: Part of the research was funded by “Botanical dietary supplements: Science-Base for Authentication” of US food and Drug Administration Grant No FD-U-002071. The authors would like to thank Missouri Botanical Garden, USA for authentic plant material and Vaishali Joshi for plant identification. Authors also thank Bharathi Avula for her kind help in acquiring the mass data. Y.J.S. is thankful to NCNPR for graduate research assistantship.

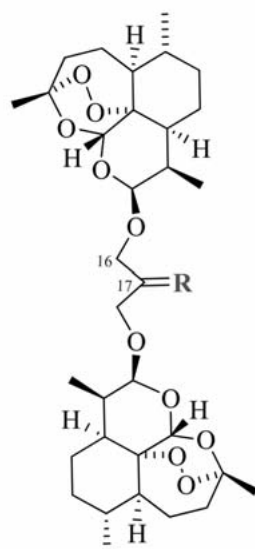
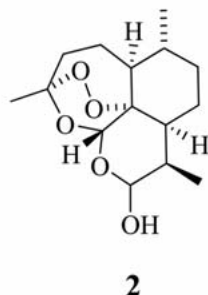
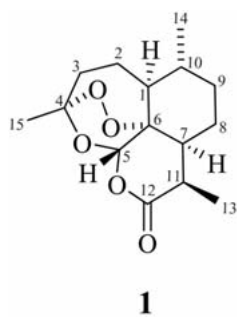

R

3 = O

4 = N-O-CH₂-CH₂-COOH

5 = N-OH

6 = N-O-CH₂-C₆H₄-CH₂-OH

7 = N-O-CH₂-CH₂-OH

Author's Index

- A**
Adams M 401
Agarwal A 423
Ahmed R 448
Akaydin G 415
Al-Amier H 432, 432
Ali N 454
Ali Z 424, 427, 428, 429, 436, 440, 445, 448, 449
Alladin T 410
Aruna Agrawal A 453
Ashfaq MK 430, 450
Avery MA 426
Avula B 418, 418, 424, 425, 427, 427, 436, 443, 443, 444, 445, 445
Aytac Z 420
- B**
Baek JP 432
Balachandran P 450
Balamurugan M 453
Baser KHC 415, 416, 420, 421, 421, 421, 422, 422
Becnel JJ 421, 422, 422
Bertoni B 419
Bhat B 412
Bolonhezi D 414
Bin Xiao 405
Brown PN 404
Butun S 421
- C**
Cao JQ 411
Carakostas MC 409
Chandra S 415, 416
Chang Y 420
Chan PWH 408
Chen JF 413, 417
Chen KL 416
Chen S 411
Chen SL 404, 407, 416
Chen WS 413, 417
Choi HK 401
Choi YH 401
Clark AM 423
Clement JA 451, 451
Coates PM 435
Cormack BP 447
Craker LE 414, 432, 432, 432
Cui JM 411
Curry LC 409
- D**
Dasmahapatra AK 448, 448
Das N 446
Dayan FE 431
Demirci B 415, 416, 421, 421, 421, 422, 422
Demirci F 415, 416
Dewedi RB 407
Ding Y 424
Doerksen RJ 431
Donia AER 414
Duali G 421
Duan YB 413, 417
Dubey GP 453
Duman H 421
Dutt HC 406
Duzgoren-Aydin NS 436
- E**
Efferth T 408
El-Hela AA 432
ElSohly MA 414, 415, 415, 416, 426, 455, 449, 449
Elujoba AA 420
Engel J 435
Erkelens T 417
- F**
Fachin AL 419
Ferreira D 424, 431, 432
Fischer M 401
Fisher KD 435
Folk W 424, 441, 442
França SC 419, 419
Fronczek F 430
Fu X 441, 442
- G**
Galal A 455
Gang DR 431
Gangemi J 452
Gao T 417
Gao Z 422, 422
Gao ZP 445
Garrett SE 451
Gbolade AA 420
Grundel E 433
Guan SH 407
Gul W 449, 449, 455
Guo J 412
Gurbuz I 416
Gusenleitner S 401
- H**
Hadi C 402
Hamann MT 431
Han J 407
Han JP 416
Harish Chandra R 454
Haron M 450
Hegazi EA 447
Helaly A 432
Hetta M 432
Hifnawy M 432
Hussien H 410
- J**
Jacob MR 423, 430
Jadhav AN 412, 425
Jiang BH 407
Jia Q 434
Johnson Q 424, 441, 442
Joshi VC 414, 425, 430
Jun Pill Baek JP 414
- K**
Kang K 420
Kang TG 420
Kaushik D 452, 452
Kaushik P 452
Kaya M 421
Kayser O 417
Kelly RM 451, 451
Khan IA 414, 414, 414, 415, 415, 415, 416, 416, 418, 418, 418, 419, 420, 421, 423, 424, 424, 424, 425, 425, 426, 426, 426, 427, 427, 428, 428, 429, 429, 436, 436, 436, 437, 438, 438, 438, 439, 440, 441, 442, 443, 443, 444, 444, 445, 445, 448, 448, 449, 455
Khan SI 420, 430, 449, 455
Kingston RL 410
Kirker GT 422
Klein M 435
Koo HJ 431
Koparal AT 421
Kridell S 451
Krogstad DJ 402
Krynitsky A 433
Kumar D 452, 452
Kumar S 452
Kumarappan CT 453
Kumarihamy M 431
- L**
Lane H 452
Lata H 414, 414, 415, 416
Laurentzi A 431
Lei Y 413
Lei Zhang L 413
LeMaster S 410
Lertora JLJ 402
Lessard S 410
Liang QL 405
Liang ZS 423
Lihua Tang LH 412
Li MH 416
Ling KH 408
Li P 434, 434
Liu X 407
Liu Y 413, 417
Liu YN 420
Li XC 423, 424, 424, 424, 441, 442
Li Z 405
Lu AP 404
Luo K 416
Lv Z 420
- M**
Mabusela W 424, 441, 442
Ma C 407
McCoy JA 419, 451
McDowell E 431
Madgula L 450
Madkour SA 447
Majumdar S 449, 449
Mandal SC 453
Manly SP 430
Marles R 410
Martinez-Ross NM 419
Matallo MB 419
Mazzola E 433
Mehmedic Z 414
Melek B 402
Mikell JR 423
Milligan G 434
Moawad A 432
Mondal (Parui) S 446
Moraes RM 414, 414, 419, 450
Muhammad I 430
Muhoro C 433
- N**
Nagabhushanam K 412
Na Han 405
Naji MA 403

Nanayakkara NPD 431
Narender R 452
Nguyen Pho A 435

O

Odde S 431
Ojha RP 453
O'May GA 447
Osman M 447
Oyededeji OA 420

P

Pal TK 446
Pang XH 417
Pan H 411
Pan SJ 447
Pan Z 415, 416
Park KW 432
Parmar PP 452
Pasco DS 414, 450, 450
Pawar RS 455
Pereira AMS 419, 419
Pereira PS 419
Phinney KW 435
Pimentel FA 419
Pounders C 415
Pridgeon J 421, 422, 422
Pugh ND 414, 450, 450

Q

Qi LW 412

R

Rader JI 433
Radhakrishnan M 453
Radwan MM 430
Rahman Z 449
Rajamanickam GV 453, 453
Rajkumar M 454
Rao AS 418, 418
Rastogi M 453
Ravishankar B 407
Repka MA 449, 449
Rimmer CA 435
Roberts A 409
Rollinger JM 402
Ross SA 430
Rouis M 403
Rumalla CS 425, 436, 445

S

Saldanha LG 435
Sampson BJ 421, 422, 422

Sander LC 435
Sarkar AK 446
Saunders JA 447
Schmitt JD 451
Schühly W 401
Schwaiger S 402
Senthil S 453
Sharpless KE 435
Shaw PC 408
Shields V 447
Shi LC 407, 416
Shirtliff ME 447
Shode FO 420
Shukla YJ 436
Sieira VC 419
Simmet T 403
Singhai AK 453
Singh J 452
Slade D 429, 455
Smeltzer M 451
Smillie TJ 424, 425, 427, 427, 428, 428, 429, 429, 436, 436, 437, 438, 438, 438, 439, 440, 441, 442, 443, 443, 444, 445, 445, 449
Song JY 407, 416, 416
Sowers KR 433
Srivastava JS 412
Stanikunaite R 430
Subrahmanya Kumar K 404
Subramanian RB 452
Sufka KJ 450
Sumiyanto J 414, 414, 450
Sun C 407, 416
Sun LZ 426
Sun S 435
Syce J 424, 441, 442

T

Tabanca N 415, 416, 420, 422, 422, 422
Tamta H 414, 450, 450
Tang L 413
Techen N 415
Tekwani BL 430
Thiagarajan M 453
Tian JK 412
Trappe JM 430
Turner JL 415

V

Vasta G 448
Vobalaboina V 454

W

Walker LA 419, 430, 449, 450
Wang EZ 403
Wang YH 418, 418, 425, 427, 436, 436, 437, 438, 438, 438, 439, 440, 441, 442
Wang YM 405
Wargovich M 452
Watts JEM 433
Weaver S 434
Wedge DE 415, 416, 420, 421, 422
Weerasooriya AD 421, 427, 427
Wendland T 448
Werle CT 421, 422, 422, 422
White KD 433
Willett KL 436
Willis TJ 451
Wise SA 435
Wu M 448
Wu XM 414, 450

X

Xiao Y 413, 417
Xie C 412
Xie CX 407, 420
Xie GB 413
Xu HX 407, 416
Xu L 420
Xu LZ 412
Xu WH 423
Xu QM 412

Y

Yadav SK 453
Yang HH 405
Yang M 407
Yang SL 412
Yao H 407, 416, 416
Yi B 413, 417
Yue QX 407

Z

Zhang L 417
Zhang WD 404
Zhang Y 411
Zheng J 413
Zhihui Liu 405
Zhou JL 412
Zhou SX 413
Zjawiony JK 431, 432