

Original Article

Quality control and GMP synthesis of ^{68}Ga -prostate-specific membrane antigen-11 for detection of low- and high-grade prostate cancer

ABSTRACT

Prostate-specific membrane antigen (PSMA) labeled with ^{68}Ga routinely used with higher sensibility and specificity than other radiotracers for detection of low and high grades of prostate cancer using positron emission tomography (PET)-computed tomography. $^{68}\text{Ge}/^{68}\text{Ga}$ generators are generally used with automated modules for the syntheses of ^{68}Ga radiopharmaceuticals. The aim of the current study is to describe the procedures for labeling PSMA with radiotracers and their standard QC tests. The automated synthesis method for ^{68}Ga -PSMA-11 was taken and set of a quality control based on chromatographic and spectrometric methods used to determine radiochemical and radionuclide purity of the radiolabeled compound. Meanwhile, high-performance liquid chromatography and rainbow trail Lutheran camp are the best choices after stability tests for assessment of radiochemical purity at the optimized conditions. The clinical utility of the synthesized radiopharmaceuticals was ascertained by performing PET scans in human patients.

Keywords: Computed tomography, positron emission tomography, prostate cancer, prostate-specific membrane antigen-11, quality control

INTRODUCTION

Prostate cancer (PCa) is one of the major malignancies affecting men with high rates of morbidity and mortality around the world.^[1] Rising two common signs (prostate-specific antigen [PSA] and Gleason Score), for detection of recurrence of the tumor after radical prostatectomy, is the most clinical markers in PCa. Computed tomography (CT) ultrasonography and bone scan is used as conventional imaging for detection of recurrence of the tumor with low sensitivity and specificity. Numerous studies on the prepared Glu-NH-CO-NH-Lys-(Ahx)-(^{68}Ga [HBED-CC]) (^{68}Ga -prostate-specific membrane antigen [PSMA]-11) showed the ability of this tracer for high contrast detection of peritoneal carcinomatosis (PC).^[2,3] ^{68}Ga -PSMA positron emission tomography (PET)-CT was demonstrated to be able to localize recurrence lesions in patients even at low level of PSA (higher than 2 ng/ml).^[4] ^{68}Ga -PSMA-11 is markedly superior to the previous radiotracers such as ^{11}C -Choline or ^{18}F -Choline which demonstrated the detection of lesions with improved

contrast, especially at low-PSA levels.^[2,5] In the present study, ^{68}Ga -PSMA-11 was prepared at the optimized conditions (pH, temperature, ligand concentration, and reaction time), and the appropriate systems for high-performance liquid chromatography (HPLC) and rainbow trail Lutheran camp (RTL) analysis were introduced. Moreover, the brief procedure and standard operating procedure (SOP) indicated for labeling PSMA ligands and its quality control. Clinically,

MAJID ASSADI^{1,2}, HABIBOLLAH DADGAR³

¹The Persian Gulf Nuclear Medicine Research Center, Bushehr University of Medical Sciences, ²Department of Molecular Imaging and Radionuclide Therapy, Bushehr Medical University Hospital, Bushehr University of Medical Sciences, Bushehr, ³Cancer Research Center, Razavi Hospital, Imam Reza International University, Mashhad, Iran

Address for correspondence: Habibollah Dadgar, Cancer Research Center, Razavi Hospital, Imam Reza International University, Mashhad, Iran.
E-mail: reza.Lt.dadgar@gmail.com

Submission: 26-Sep-18, **Accepted:** 11-Oct-18, **Published:** 23-Jul-2019

This is an open access journal, and articles are distributed under the terms of the Creative Commons Attribution-NonCommercial-ShareAlike 4.0 License, which allows others to remix, tweak, and build upon the work non-commercially, as long as appropriate credit is given and the new creations are licensed under the identical terms.

For reprints contact: reprints@medknow.com

How to cite this article: Assadi M, Dadgar H. Quality control and GMP synthesis of ^{68}Ga -prostate-specific membrane antigen-11 for detection of low- and high-grade prostate cancer. World J Nucl Med 2020;19:93-8.

Access this article online	
Website: www.wjnm.org	Quick Response Code 
DOI: 10.4103/wjnm.WJNM_82_18	

⁶⁸Ga is available from a ⁶⁸Ge to ⁶⁸Ga generator and due to its long half-life (T_{1/2} = 271 days) allows the generator to be used for several months.^[4] In addition, the short half-life of ⁶⁸Ga (T_{1/2} = 68 min) permits operators for more elution of the generator in 1 day. As PSMA overexpressed in PCa cells, it can be an ideal target for labeling to radiopharmaceuticals for binding with peripheral membrane cell receptors.^[6,7] PSMA-11 [Figure 1] has been developed for labeling with ⁶⁸Ga.^[8] While in many centers, preparation of ⁶⁸Ga-PSMA-11 is systematic; pharmaceutical purity tests of the final product is highly significant for radiopharmacists. Purification tests at the end of synthesis are done to remove unbinding ⁶⁸Ga and ⁶⁸Ge from the generator. GMP is needed to ensure the production of sterile and product safe for administration in patients. In short, the current paper summarizes our experience in the production of ⁶⁸Ga-PSMA-11 using an automated synthesis module obtained from Scintomics, Germany.

MATERIALS AND METHODS

PSMA-11 was afforded from ABX advanced biochemical compounds (Radeberg, Germany). The production of PSMA peptide labeled with ⁶⁸Ga was done with the use of the 40 mCi ⁶⁸Ge/⁶⁸Ga generator which approved from Pars Isotope Co. (Tehran, Iran) with 0.5 M hydrochloric acid for elution. The labeling kit contains 30 μg PSMA peptide, 45 mg sodium acetate, 25mg ascorbic acid, ethanol (99.8% and 50%), water for injection, sterile filter 0.22 μm, 0.9% NaCl, and C18 SPE cartridge. The Scintomics GRP module was used for automated synthesis. All radioactivity measurements are proceeding with using the Capintec dose calibrator in ⁶⁸Ga-window mode.

Reagents were prepared from Merck and Sigma-Aldrich (Germany) and used without further purification unless otherwise stated. Ultrapure water was prepared by DIRECT-Q3 water purification system (Merck Millipore, Germany) and used for all generator and reaction solutions. Radio thin-layer chromatography (TLC) was performed using silica gel 60F254, 0.5 mm (Merck KGaA, Darmstadt, Germany) and glass microfiber

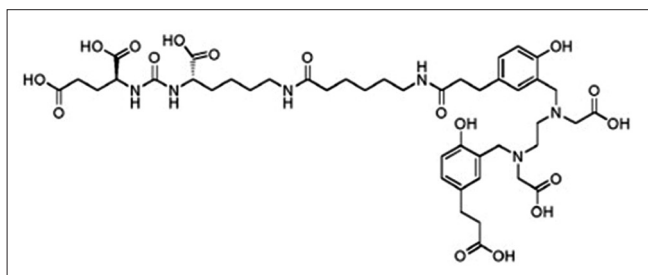

Figure 1: Structure of DKFZ-prostate-specific membrane antigen-11

chromatography paper impregnated with silica-gel (iTLC-SG, Agilent Technologies, Santa Clara, California). The analysis was performed with a single trace TLC scanner (miniGita; Elysia-raytest, Straubenhardt, Germany). Radio-HPLC was performed using an Agilent 1260 reverse phase HPLC system on an Acclaim 120 C18 (3 μm, 3.0 × 150 mm) column equipped with a Gabi γ-HPLC flow detector (Elysia-raytest, Straubenhardt, Germany). HPLC was used to determine the radiochemical purity. The peptides were eluted applying different gradients of 0.67% (v/v) trifluoroacetic acid (TFA) in H₂O (solvent A) and 0.1% TFA (v/v) in acetonitrile (solvent B) at a constant flow of 0.5 mL/min. Identification and quantification of long-living impurities were performed by a multi-channel analyzer for γ-spectroscopy (Mucha, Elysia-raytest, Straubenhardt, Germany). The radionuclidic purity of the final product solution and separation cartridges was analyzed using gamma spectrometry. The bacterial endotoxin test is performed using Endosafe[®]-PTS[™] (Charles River, USA) apparatus. Fast radiolabeling of HBED-CC represents which this radiopharmaceutical is a stable at room temperature. Clinical ⁶⁸Ga-PSMA-11 PET/CT scanning resulted in high-quality images in patients.

Automated synthesis of ⁶⁸Ga-prostate-specific membrane antigen-11

First, module prepared by connecting the reagents to the appropriate tubes and by filling the reactor with the 20 μl of PSMA-11 peptide solution in water at the concentration of 1 mg/ml and 2 ml of 1.5 M HEPES buffer solution as it is shown in Figure 2.

After the initial check of the Scintomics GRP module software, the preparations are complete. For choosing the best concentration of eluent, the generator was eluted by 5 mL HCl with various concentrations from 0.1 to 1.0 M and the activity of the eluted ⁶⁸Ga was measured using high-purity

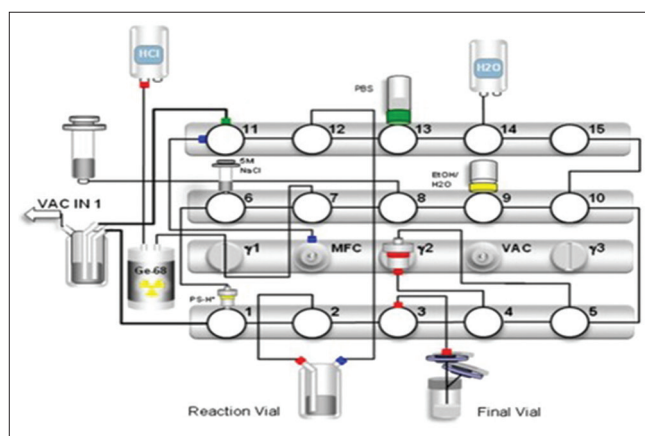

Figure 2: Schematic automated procedures for synthesis of ⁶⁸Ga-prostate-specific membrane antigen-11

germanium (HPGe) detector. Regarding the using SOP for production of ^{68}Ga -PSMA-11 in our department, elution with 5 ml 0.5 M HCl performed as the more suitable solvent for the labeling process. 511 and 1016 keV peaks indicated in the Gamma spectrum of eluted $^{68}\text{GaCl}_3$ [Figure 3].

After the elution, synthesis module starts the labeling process around 20 min to finalization. The temperature of reaction vial is set at 100°C to ensure the labeling runs well. Through the labeling process, ^{68}Ga chloride transferred to the PSH+ cartridge to remove the remained hydrochloric acid and then continuously move to the reactor with 2 ml of acidified 5.0 M NaCl. In the next part, purification stage commences, and the reaction mixture sends to the C18 cartridge. While C18 cartridge is conditioned with 2 ml of 99.8% ethanol and 10 ml of water and dried with air, the ^{68}Ga labeled PSMA absorbed by the cartridge and then HEPES in the reaction mixture is removed. Then, the C18 cartridge washed with water to ensure that the HEPES buffer and other impurities completely removed from the mixture. At the final section, the product removed from the C18 cartridge with 2 ml of ethanol and transferred to the product vial. After the removal of the ^{68}Ga labeled PSMA, the C18 cartridge more flushed with 20 ml of phosphate buffered saline solution to ensure the proper concentration and a pH level of the obtained product.

Quality control methods

Gamma ray spectroscopy

Gamma spectroscopy is one of the nuclide identification tests that measure the energy of the detected gamma ray which use the multichannel analyzer.^[9] Breakthrough measured by counting the same sample at 48 h after the first test for the detection of ^{68}Ge . RTLC was performed for the evaluation of radiochemical purity of the eluted ^{68}Ga . RTLC chromatograms of $^{68}\text{GaCl}_3$ solution were performed in 10% ammonium acetate/methanol on silica gel sheets and in 10 mM DTPA solution (pH = 4) on Whatman No. 2 paper [Figure 4].

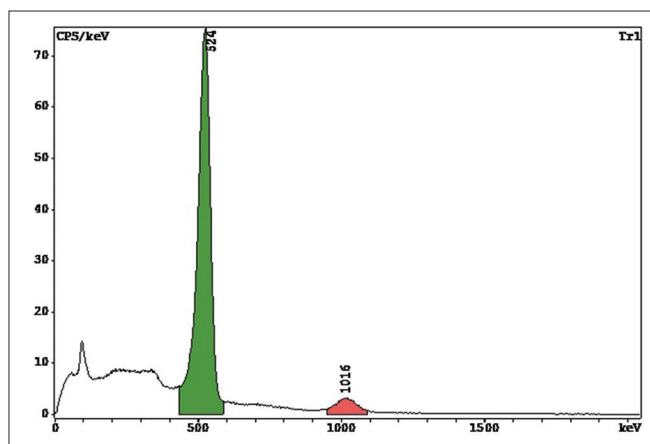

Figure 3: Gamma spectrum of eluted $^{68}\text{GaCl}_3$ 3-Ray test Mucha

Half-life determination

The purpose of this assay is to define the isotope. The half-life of the radiotracer is obtained with the use of dose calibrator for the activity measurements. The expected half-life of ^{68}Ga is around 67.6 min.^[10]

Bacterial endotoxin purity

The bacterial endotoxin test is performed using Endosafe[®]-PTS[™] (Charles River) apparatus and the kinetic chromogenic Limulus amoebocyte lysate-test method also applied.^[11]

Radionuclide purity

Gamma spectroscopy of the final product also performed in the same way^[10-12] in a Canberra-Packard gamma spectrometer equipped with an HPGe detector. The spectra acquisition is carried out 2 days after synthesis. The acquisition is proceeded for 180 min to obtain high a signal-to-noise ratio. The sample volume should be at least 1 ml.

Liquid chromatography (high-performance liquid chromatography)

To determine radiochemical and chemical purity of ^{68}Ga -PSMA a reversed-Phase HPLC (Agilent 1260 reverse phase HPLC system) used with a Acclaim 120°C18 (3 μm , 3.0 \times 150 mm) column equipped with a Gabi γ -HPLC flow detector (Elysia-raytest, Straubenhardt, Germany). Ultraviolet (UV) absorbance is measured at wavelength 254.0 nm and 284.0 nm. The injection volume is 50 μl . The better results were obtained during the measurements at a wavelength of 284 nm, and that is why it was decided to measure the ^{68}Ga -labeled PSMA-11 peptide at this wavelength. During the tests, it was found that the concentration of ^{68}Ga -PSMA in the sample diluted with a saline is below the detection limit of radiometric detector (synthesis product is diluted with saline to provide isotonicity). In the chromatograms, two signals may be observed. The high pick signal comes from ^{68}Ga -PSMA-11 and the second signal does not affect the test

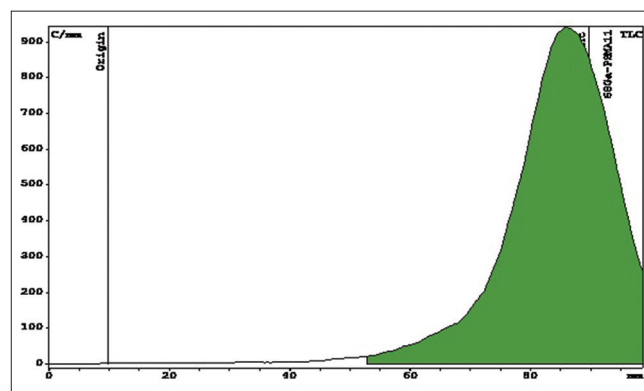

Figure 4: Rainbow Trail Lutheran camp chromatogram of $^{68}\text{GaCl}_3$ solution

result. These signals observed both on the UV detector and the radiometric detector.

DISCUSSION AND CLINICAL HUMAN STUDIES

PC is one of the highlighted malignancies affecting men around the world. Previously, $^{99\text{m}}\text{Tc}$ -MDP was used as a gold standard for detecting bone metastatic of PCa and following. In addition, radiolabeled anti-PSMA antibody (Capromab pendetide, ProstaScint) was applied for the diagnosis of soft-tissue metastasis and recurrence in PCa patients. Due to low accuracy and technical challenge, it is not applied in most places.^[13] Recently, while several PET tracers have been performed for evaluation of PC, meanwhile the small molecular weight inhibitors targeting PSMA was developed as a good tracer for labeling with ^{68}Ga .^[3] Due to the long half-life of $^{68}\text{Ge}/^{68}\text{Ga}$ generator, gallium-68 can be promising radionuclide in PET-CT imaging. While both ^{18}F and ^{68}Ga have been clinically indicated for imaging of PCa,^[11,14,15] ^{68}Ga is a useful tracer every time of the day for production and analyzing rather than using of ^{18}F tracers because ^{18}F needs the cyclotron for production, but ^{68}Ga production depends on the generator elution. Pathologically, recurrence of PCa is usually evaluated by increasing PSA levels. In PCa, biochemical relapse is frequent and occurs in 20%–30% after radical prostatectomy and up to 60% after primary radiation therapy.^[16] Several clinical studies were undertaken to assess the value of PSMA PET/CT and PET/MRI in the clinical management of PCa.^[17] Furthermore, molecular imaging with PSMA PET is paving the direction for precision medicine in PCa. Precision medicine will assist in risk evaluation, diagnosis, prevention, and therapy particularly tailored to the distinctive features of the individual thus increasing the health.^[18] Kozikowski *et al.* first described PSMA inhibitors for PCa imaging.^[19] Preclinical imaging using PSMA radiotracers was reported by Pomper *et al.* in the PSMA-positive tumor xenografts.^[20] The first clinical study on human using ^{68}Ga -PSMA-11 was established in 2011, and continuously, the first clinical papers ^{68}Ga -PSMA-11 PET/CT imaging were published in 2012 by Afshar-Oromieh *et al.*^[21] ^{68}Ga -PSMA developed by the Heidelberg group at the German Cancer Research Center (DKFZ) Heidelberg. Synthesis and preclinical evaluation of ^{68}Ga -PSMA-11 was performed by Eder *et al.* regarding to the aforementioned clinical base studies in the DKFZ center.^[22] As previously assessed, PSMA-11 cannot clinically conjugated with therapeutic radiometals such as Lu-177 or Ac-225. Therefore, PSMA-11 can just be used for diagnostic and imaging purposes. However, it soon became clear that PSMA inhibitors can also be used for PSMA radioligand therapy of PCa. Recently, clinical theranostic approach using PSMA inhibitor MIP-1095 was reported in 2014 by Zechmann and Hillier *et al.*^[23,24] Consequently, PSMA-617 introduced by the Heidelberg center as a theranostic ligand which can also

be radiolabelled with the therapeutically radiometals such as Lu-177 for beta therapy and Ac-225 for alpha therapy.^[25,26]

In the current report, we presented intense uptake of ^{68}Ga -PSMA PET/CT in early and late monitoring (restaging) of a 74-year-old male patient with prostate carcinoma diagnoses. He had diagnosed as prostate adenocarcinoma in 2016 and been followed up in 2017 using ^{68}Ga -PSMA-11. In addition, chemo-radiation therapy using Taxotere following partial cystectomy had been applied for high-grade invasive prostate carcinoma. After chemotherapy and hormone therapy (Zometa), the patient underwent ^{68}Ga -PSMA PET/CT for the elevation of serum PSA levels (early scan). In the early PET/CT scan, the patient had PSA = 11 ng/ml. For this procedure, 60MBq of Ga-68 PSMA-11 was administered intravenously through the left antecubital vein. To allow for distribution and uptake of radiotracer, the patient was allowed to rest quietly for 60 min in a shielded room. Imaging was performed on an integrated 6-slice PET/CT scanner, with scanning from the skull base to the toes. CT scanning was performed without oral or intravenous contrast material. In maximum intensity projection and transaxial fused images, multiple mediastinal lymph node involvement in supraclavicular, retrosternal, lower paratracheal, and left internal mammary stations high uptake were detected [Figure 5]. In addition, lymph node involvement in the paraaortic area (3–4 small sizes lymph nodes), right iliac wing and T9 and 11th left ribs were reported. After following the patient, who underwent hormone therapy each 3 months, PSA level rose up from 11 to 36 ng/ml and chemotherapy with no change in PSA levels was regarded. Therefore, ^{68}Ga -PSMA PET/CT has been performed again for imaging of recurrent prostate carcinoma progression.^[15] For achieving this goal, the same PET/CT imaging protocol was done. After interpretation of the results, the same scan patterns found like pervious study in the bilateral supraclavicular lymph nodes, 9 mm lymph node in the paratracheal region, 15 mm lymph node in the retrosternal area. Furthermore, 2–3 another lymph nodes in the lower paratracheal and retrosternal stations with increased uptake were noted. Lymph node in AP window which was 8 mm with SUVmax = 10 now became 20 mm with SUVmax = 17.3. Finally, new lymphatic involvements in the left retrocrural, AP window in addition to the previously noted multiple mediastinal lymph node involvement in supraclavicular, retrosternal, lower paratracheal, and left internal mammary stations were diagnosed. Moreover, lymph node involvement in the paraaortic area (3–4 small-sized lymph nodes) and new bone lesions in the sternum, left scapula, multiple ribs, T5, multiple lower thoracic and lumbar vertebrae, and iliac wings were seen in Figure 6. Therefore, following patients correlated with PCa using ^{68}Ga -PSMA PET/CT (same protocols) can be useful for the assessment of

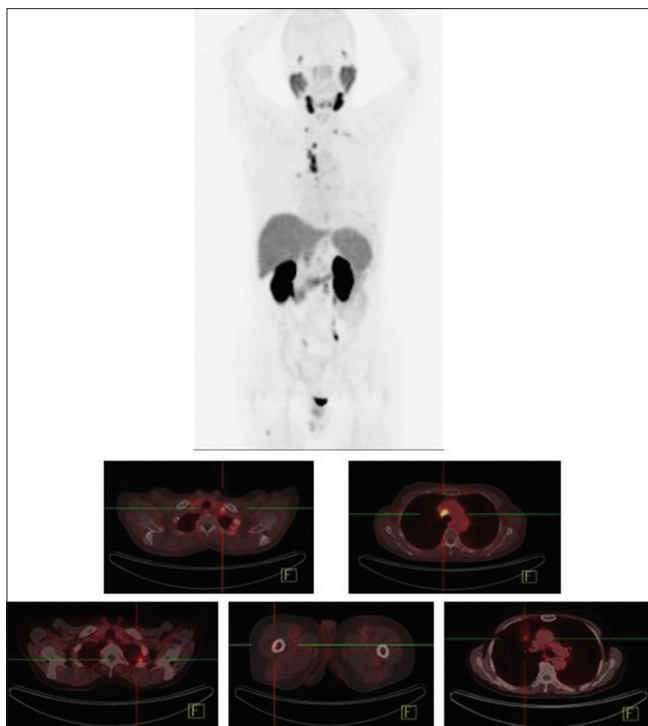

Figure 5: Early ⁶⁸Ga-prostate-specific membrane antigen -11 positron emission tomography/computed tomography with 11 ng/ml PSA level. MIP section and transaxial metastasis involvement lesions

progression, recurrences assessment, and response to therapy. Regarding to this issue, these days many authors focused on developing new radiopharmaceuticals for early diagnosis of PCa.^[20,27] Furthermore, due to nonsecreting character and internalization after ligand binding endocytosis, PSMA has taken valuable interest for theranostics. Theranostics in the combination of a diagnostic technique that assists to specify the right therapeutic method for define disease. It has very high potential to validate the “treat what you see and see what you treat” concept, therefore, enable to accelerate and improve cancer management in precision care in prostate oncology.^[28] Imaging and therapy of PCa is an instant of successful application of the theranostics concept and a valid sample of personalized medicine.^[29] Molecular imaging with PSMA PET has the ability of representing interlesional between primary and metastatic lesions and is useful in the evaluation of heterogeneity between the primary and metastatic lesions. All these will help in tailored treatment on an individual basis in heterogeneous lesions of this tumor.^[30,31]

CONCLUSION

⁶⁸Ga was obtained from the ⁶⁸Ge/⁶⁸Ga generator, and the results of quality control analysis including radionuclidic, chemical, and radiochemical purities indicated the high

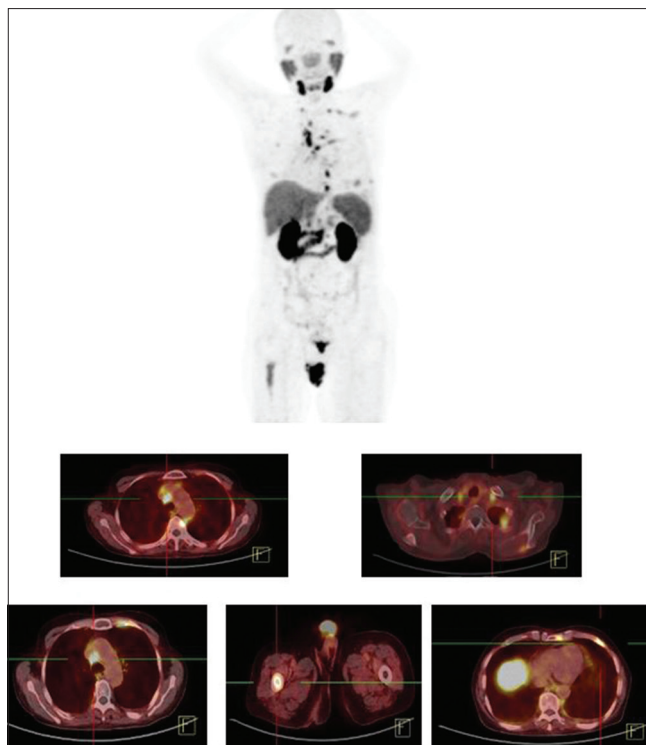

Figure 6: Following ⁶⁸Ga-prostate-specific membrane antigen-11 positron emission tomography/computed tomography with 36 ng/ml PSA level. MIP section and transaxial metastasis involvement lesions

purity of the eluted ⁶⁸Ga. Regarding the low uptake of activity in other organs, this compound can be considered as a promising agent for PET imaging of PCa in low and high grades.

Declaration of patient consent

The authors certify that they have obtained all appropriate patient consent forms. In the form the patient(s) has/have given his/her/their consent for his/her/their images and other clinical information to be reported in the journal. The patients understand that their names and initials will not be published and due efforts will be made to conceal their identity, but anonymity cannot be guaranteed.

Financial support and sponsorship

Nil.

Conflicts of interest

There are no conflicts of interest.

REFERENCES

1. Afshar-Oromieh A, Zechmann CM, Malcher A, Eder M, Eisenhut M, Linhart HG, *et al.* Comparison of PET imaging with a (⁶⁸Ga)-labelled PSMA ligand and (¹⁸F)-choline-based PET/CT for the diagnosis of recurrent prostate cancer. *Eur J Nucl Med Mol Imaging* 2014;41:11-20.

2. von Eyben FE, Kairemo K. Meta-analysis of (11)C-choline and (18) F-choline PET/CT for management of patients with prostate cancer. *Nucl Med Commun* 2014;35:221-30.
3. Afshar-Oromieh A, Avtzi E, Giesel FL, Holland-Letz T, Linhart HG, Eder M, *et al.* The diagnostic value of PET/CT imaging with the (68)Ga-labelled PSMA ligand HBED-CC in the diagnosis of recurrent prostate cancer. *Eur J Nucl Med Mol Imaging* 2015;42:197-209.
4. Eppard E, Homann T, de la Fuente A, Essler M, Rösch F. Optimization of labeling PSMA^{HBED} with ethanol-postprocessed ⁶⁸Ga and its quality control systems. *J Nucl Med* 2017;58:432-7.
5. Eder M, Neels O, Müller M, Bauder-Wüst U, Remde Y, Schäfer M, *et al.* Novel preclinical and radiopharmaceutical aspects of [68Ga] Ga-PSMA-HBED-CC: A new PET tracer for imaging of prostate cancer. *Pharmaceuticals (Basel)* 2014;7:779-96.
6. Mease RC, Foss CA, Pomper MG. PET imaging in prostate cancer: Focus on prostate-specific membrane antigen. *Curr Top Med Chem* 2013;13:951-62.
7. Eiber M, Maurer T, Souvatzoglou M, Beer AJ, Ruffani A, Haller B, *et al.* Evaluation of hybrid ⁶⁸Ga-PSMA ligand PET/CT in 248 patients with biochemical recurrence after radical prostatectomy. *J Nucl Med* 2015;56:668-74.
8. Satpati D, Shinto A, Kamaleswaran KK, Sane S, Banerjee S. Convenient preparation of [(68)Ga]DKFZ-PSMA-11 using a robust single-vial kit and demonstration of its clinical efficacy. *Mol Imaging Biol* 2016;18:420-7.
9. Bařinka C, Rojas C, Slusher B, Pomper M. Glutamate carboxypeptidase II in diagnosis and treatment of neurologic disorders and prostate cancer. *Curr Med Chem* 2012;19:856-70.
10. Schäfer M, Bauder-Wüst U, Leotta K, Zoller F, Mier W, Haberkorn U, *et al.* A dimerized urea-based inhibitor of the prostate-specific membrane antigen for ⁶⁸Ga-PET imaging of prostate cancer. *EJNMMI Res* 2012;2:23.
11. Ebenhan T, Vorster M, Marjanovic-Painter B, Wagener J, Suthiram J, Modiselle M, *et al.* Development of a single vial kit solution for radiolabeling of ⁶⁸Ga-DKFZ-PSMA-11 and its performance in prostate cancer patients. *Molecules* 2015;20:14860-78.
12. Banerjee SR, Pullambhatla M, Byun Y, Nimmagadda S, Green G, Fox JJ, *et al.* ⁶⁸Ga-labeled inhibitors of prostate-specific membrane antigen (PSMA) for imaging prostate cancer. *J Med Chem* 2010;53:5333-41.
13. Ghosh A, Wang X, Klein E, Heston WD. Novel role of prostate-specific membrane antigen in suppressing prostate cancer invasiveness. *Cancer Res* 2005;65:727-31.
14. Rizvi T, Deng C, Rehm PK. Indium-111 capromab pendetide (ProstaScint®) demonstrates renal cell carcinoma and aortocaval nodal metastases from prostate adenocarcinoma. *World J Nucl Med* 2015;14:209-11.
15. Lütje S, Heskamp S, Cornelissen AS, Poeppel TD, van den Broek SA, Rosenbaum-Krumme S, *et al.* PSMA ligands for radionuclide imaging and therapy of prostate cancer: Clinical status. *Theranostics* 2015;5:1388-401.
16. Khuntia D, Reddy CA, Mahadevan A, Klein EA, Kupelian PA. Recurrence-free survival rates after external-beam radiotherapy for patients with clinical T1-T3 prostate carcinoma in the prostate-specific antigen era: What should we expect? *Cancer* 2004;100:1283-92.
17. Kranzbühler B, Nagel H, Becker AS, Müller J, Huellner M, Stolzmann P, *et al.* Clinical performance of ⁶⁸Ga-PSMA-11 PET/MRI for the detection of recurrent prostate cancer following radical prostatectomy. *Eur J Nucl Med Mol Imaging* 2018;45:20-30.
18. Ghasemi M, Nabipour I, Omrani A, Alipour Z, Assadi M. Precision medicine and molecular imaging: New targeted approaches toward cancer therapeutic and diagnosis. *Am J Nucl Med Mol Imaging* 2016;6:310-27.
19. Kozikowski AP, Nan F, Conti P, Zhang J, Ramadan E, Bzdega T, *et al.* Design of remarkably simple, yet potent urea-based inhibitors of glutamate carboxypeptidase II (NAALADase). *J Med Chem* 2001;44:298-301.
20. Rowe SP, Drzezga A, Neumaier B, Dietlein M, Gorin MA, Zalutsky MR, *et al.* Prostate-specific membrane antigen-targeted radiohalogenated PET and therapeutic agents for prostate cancer. *J Nucl Med* 2016;57:90S-6S.
21. Afshar-Oromieh A, Haberkorn U, Eder M, Eisenhut M, Zechmann CM. [68Ga]Gallium-labelled PSMA ligand as superior PET tracer for the diagnosis of prostate cancer: Comparison with ¹⁸F-FECH. *Eur J Nucl Med Mol Imaging* 2012;39:1085-6.
22. Eder M, Schäfer M, Bauder-Wüst U, Hull WE, Wängler C, Mier W, *et al.* ⁶⁸Ga-complex lipophilicity and the targeting property of a urea-based PSMA inhibitor for PET imaging. *Bioconjug Chem* 2012;23:688-97.
23. Zechmann CM, Afshar-Oromieh A, Armor T, Stubbs JB, Mier W, Hadaschik B, *et al.* Radiation dosimetry and first therapy results with a (¹²⁴I/¹³¹I)-labeled small molecule (MIP-1095) targeting PSMA for prostate cancer therapy. *Eur J Nucl Med Mol Imaging* 2014;41:1280-92.
24. Hillier SM, Maresca KP, Femia FJ, Marquis JC, Foss CA, Nguyen N, *et al.* Preclinical evaluation of novel glutamate-urea-lysine analogues that target prostate-specific membrane antigen as molecular imaging pharmaceuticals for prostate cancer. *Cancer Res* 2009;69:6932-40.
25. Benešová M, Bauder-Wüst U, Schäfer M, Klika KD, Mier W, Haberkorn U, *et al.* Linker modification strategies to control the prostate-specific membrane antigen (PSMA)-targeting and pharmacokinetic properties of DOTA-conjugated PSMA inhibitors. *J Med Chem* 2016;59:1761-75.
26. Benešová M, Schäfer M, Bauder-Wüst U, Afshar-Oromieh A, Kratochwil C, Mier W, *et al.* Preclinical evaluation of a tailor-made DOTA-conjugated PSMA inhibitor with optimized linker moiety for imaging and endoradiotherapy of prostate cancer. *J Nucl Med* 2015;56:914-20.
27. Sasikumar A, Joy A, Nanabala R, Pillai MR, Thomas B, Vikraman KR. (68) Ga-PSMA PET/CT imaging in primary hepatocellular carcinoma. *Eur J Nucl Med Mol Imaging* 2016;43:795-6.
28. Jadvar H. Targeted radionuclide therapy: An evolution toward precision cancer treatment. *AJR Am J Roentgenol* 2017;209:277-88.
29. Bradley CA. [¹⁷⁷Lu]PSMA-617 radionuclide therapy shows promise. *Nat Rev Urol* 2018;15:468.
30. Li Q, Deng Q, Chao HP, Liu X, Lu Y, Lin K, *et al.* Linking prostate cancer cell AR heterogeneity to distinct castration and enzalutamide responses. *Nat Commun* 2018;9:3600.
31. Choudhury P, Gupta M. Personalized and precision medicine in cancer: A theranostic approach. *Curr Radiopharm* 2017;10:166-70.